

TOSHIBA

AIR CONDITIONER (SPLIT TYPE) Owner's Manual

R32

Indoor Unit

For commercial use

Model name:

<Concealed Duct Type>

RAV-HM561BTP-E
RAV-HM801BTP-E
RAV-HM901BTP-E
RAV-HM1101BTP-E
RAV-HM1401BTP-E
RAV-HM1601BTP-E

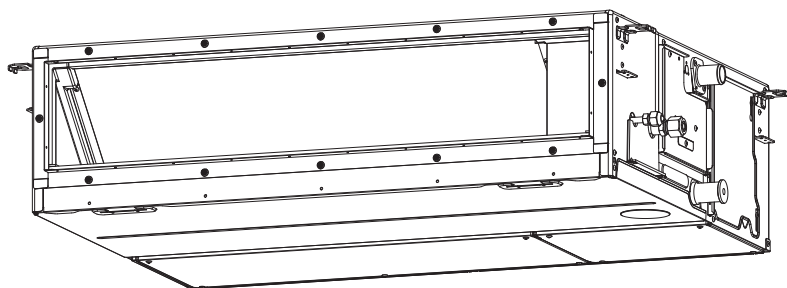

Scan QR CODE to access installation and owner's manual on website.

<https://www.toshiba-carrier.co.th/manuals/default.aspx>

Manual are available in AR/BG/CZ/DA/DE/EL/EN/ES/ET/FI/FR/
HR/HU/IT/LT/LV/NL/NO/PL/PT/RO/RU/SK/SL/SV/TR.













Original instruction

Thank you very much for purchasing TOSHIBA Air Conditioner.
 Please read this Owner's Manual carefully before using your Air Conditioner.
 • Be sure to obtain the "Owner's Manual" and "Installation Manual" from constructor (or dealer).
 • Request to constructor or dealer
 Please clearly explain the contents of the Owner's Manual and hand over it.

Information on the transportation, handling and storage of the carton

Examples of indication on the carton

Symbol	Description	Symbol	Description
	Keep dry		Do not drop
	Fragile		Do not lay down
	Stacking height (8 cartons can be stacked in this case)		Do not walk on this carton
	This side up		Do not step
	Handle with care		

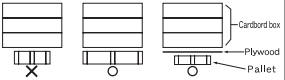
Other cautions	Description
 <p>Caution Injury possibility. Don't handle with packing band, or may get injured in case of broken band.</p>	<p>CAUTION Injury possibility. Don't handle with packing band, or may get injured in case of broken band.</p>
<p>Stacking notice. In case that cardboard boxes protrude out of pallet when stacking, lay a 10mm thick plywood over the pallet.</p> 	<p>Stacking notice. In case that cardboard boxes protrude out of pallet when stacking. Lay a 10 mm thick plywood over the pallet.</p>

Contents

1 Part names	2
2 Part names and functions of the remote controller	2
3 Operation	3
4 Timer operation	4
5 Maintenance	5
6 Troubleshooting	6
7 Operations and performance	7
8 Installation	7
9 Specifications	8

1 Part names

■ Indoor unit

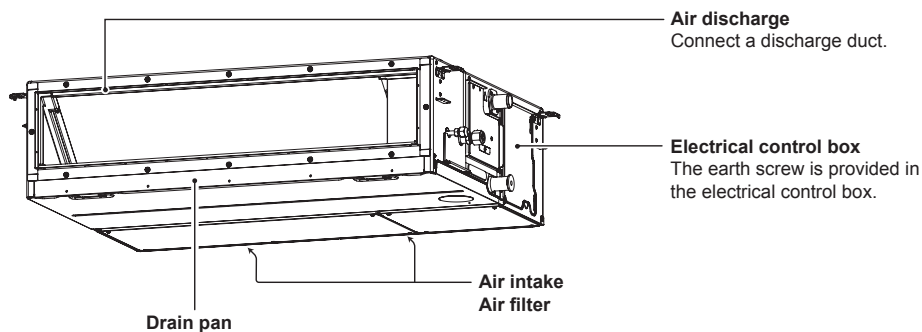

■ Outdoor unit (The design varies depending on the outdoor unit. The following illustration shows an example.)

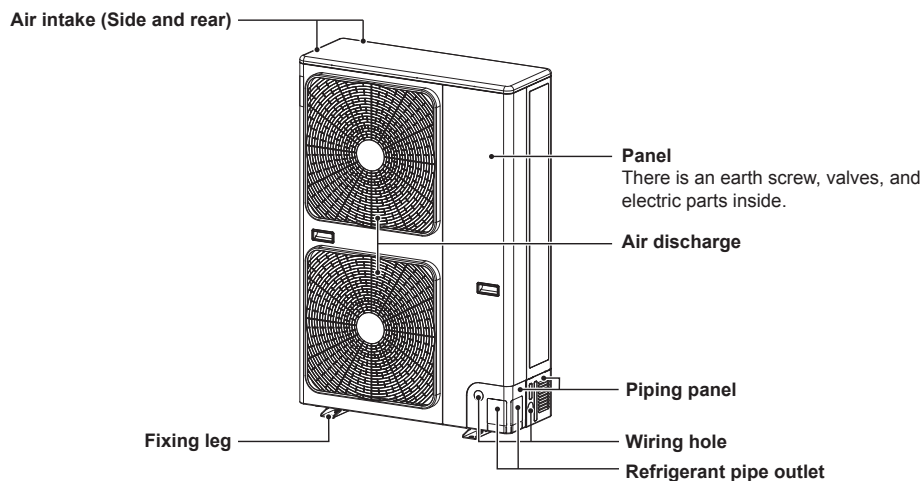

2 Part names and functions of the remote controller

Remote controller model name: RBC-ASCU1*

LCD back-light lights for 15 seconds during remote controller operation.
All indicators are displayed in the display example below.
Actually, only the selected options will be displayed.

■ Operations

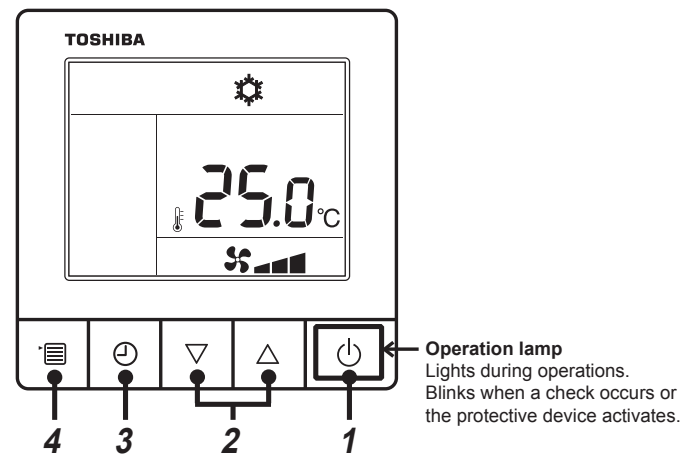

1 ON/OFF button

Press the button to turn on the air conditioner, and press the button again to turn off the air conditioner.

2 Setting button

It is used for temperature setting in general conditions. In running mode, fan speed mode and wind direction mode, it is used for the change of respective settings.

3 Timer off button

Set the timer off.

4 Menu button

It is used for the selection of the running mode, fan speed and wind direction. Press of the button each time, then it will switch in the following order.

- In different modes of the indoor unit, the selection of fan speed or wind direction may be omitted.

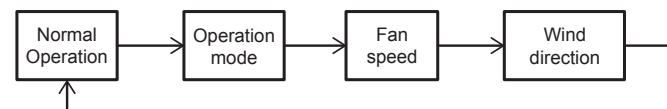

■ Indicators icon

All icons on the display are shown for this explanation. Operations are not accepted when "SETTING" is flashing.

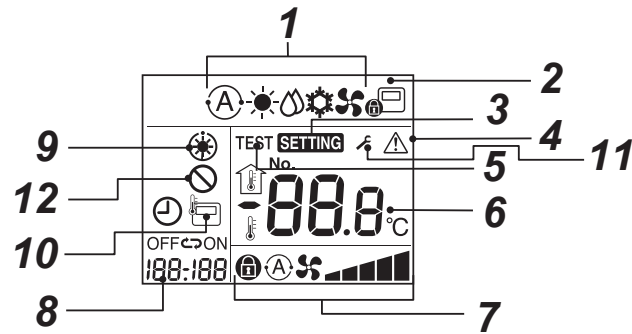

- 1 Running mode indication icon**
Indicate the selected running mode.
- 2 Central control indication icon**
It will be displayed when the air conditioner is centrally controlled and used by a central remote controller and other central control devices.
If the central control prohibits using the remote controller, will flash when pressing the ON/OFF, mode or temperature button on the remote controller, indicating that these buttons do not work. (The settings that can be configured on the remote controller will vary depending on the central control mode. For details, please read the Owner's Manual of the central remote controller.)
- 3 Setting indication icon**
Indicate that the system is checking automatically after the circuit breaker has been disconnected or other conditions have occurred.
- 4 Repair indication icon**
Display when performing an inspection or the protective device is running.
- 5 Test run indication icon**
Display during the test run period.
- 6 Temperature setting indication icon**
Display the selected setting temperature.
- 7 Fan speed indication icon**
Indicate the selected fan speed.
Auto
Low
Low+
Med.
Med. +
High
Fix
- 8 OFF timer indicator**
When a trouble occurs, a check code is displayed.
- 9 Pre-heat indicator**
Displayed when the heating mode is energized or defrost cycle is initiated.
While this indication is displayed, the indoor fan stops or operate in fan mode.
- 10 Remote controller sensor indicator**
Displayed while the sensor of the remote controller is used.
- 11 Notice display**
Displayed while notice code occurs.
For details, contact your dealer (distributor).
- 12 No function display**
Displayed when the function requested is not available on that model.

3 Operation

When you use the air conditioner for the first time or change the settings, please follow the steps below. From then on, press the On/Off button to run the air conditioner with the selected settings.

■ Standby

When "SETTING" flickers, the operation will not be accepted by system.

REQUIREMENT

- During use, keep the power switch in open state.
- When you use it again after a long time, please turn on the power switch at least 12 hours in advance.
- About 1 minute after the power is turned on, the remote controller can work. This is not a fault.

■ Run operation

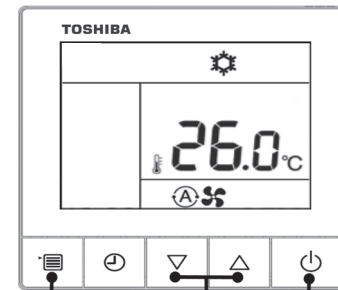

Menu button Set button ON/OFF button

- 1 ON/OFF button**
Press the button to light up the running indicator, and start running.
- 2 Select running mode**
Switch to the running mode by pressing the menu button.
 - The current running mode icon flickers.

Press the set button each time, then the running mode and its icons change in the following order :

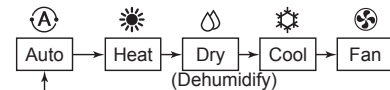

- "Dehumidify" is not available for concealed duct high static press type.
- If the button is not operated within 30 seconds, the running mode selection will end.

- 3 Select the fan speed**

Switch to the fan speed mode by pressing the menu button.

- The current fan speed icon flickers.

Press the set button each time, then the fan speed mode and its indication change in the following order :



- The fan speed that can be set will vary depending on the connected indoor units.
- In the fan mode, "Auto" cannot be selected.
- These models that cannot set the fan speed will display "Fix".
- If the button is not operated within 30 seconds, the fan speed selection will end.

- 4 Temperature selection**

Press the set button to adjust the temperature.

- Temperature setting range is from 18.0°C to 29.0°C
- The sensitivity of temperature adjustment is 0.5°C.

NOTE

Auto Changeover

- When in Auto Mode, the unit selects the operating mode (cooling, heating or fan only) based on the user set point temperature.
- If the Auto mode is uncomfortable, you can select the desired conditions manually.

Cooling

- If there is a demand for cooling, unit will start approximately 1 minute after mode is selected.
- When the room temperature reaches the set temperature, the outdoor unit stops and the indoor unit fan runs at extremely low speed.

Heating

- If there is a demand for heating, unit will start approximately 3 to 5 minutes after the mode is selected.
- After the heating operation has stopped, fan may continue to run for approx. 30 seconds.
- When the room temperature reaches the set temperature, the outdoor unit stops and the indoor unit fan runs at extremely low speed.
- During defrost operation, the fan stops so that cool air is not discharged. ("⊕" Pre-heat is displayed.)

When operation is restarted after stop



When the unit is attempted to restart immediately after it was stopped, the unit can not start for approx. 3 minutes this is to protect the compressor.

■ 8°C operation (For object pre-heating)

The air conditioner can control the heating temperature to about 8°C in the heating mode.

The 8°C heating operation requires settings with the wired remote controller. Ask the installer or dealer for the settings according to the installation manual of the indoor unit.



Start

1. Set the displayed temperature to 18°C in the heating mode by pushing TEMP.  button.
2. Set the displayed temperature to 8°C by pushing TEMP.  button for at least 4 seconds.

Stop

1. Set the displayed temperature to 18°C by pushing TEMP.  button.
 - The air conditioner returns to the normal HEAT mode. Select a desired temperature and operation mode.

NOTE

- The discharged air temperature is lower than that in the normal heating operation.
- The room temperature may not be heated evenly depending on the remote controller installation location.
- The room temperature may not reach 8°C depending on the room size or the installation conditions.
- Setting for fan speed is available during the 8°C heating operation.
 - The 8°C heating operation is cancelled in the following cases.
 - When operation is stopped with  button.
 - When another operation mode is selected with  button.
 - When temperature setting or operation mode is changed or operation is started / stopped by the wireless remote controller or the central control remote controller.
- When this operation mode is used, observe proper operating hours and we recommend that you ask service staff for periodic maintenance of the air conditioner.

4 Timer operation

OFF timer: The indoor unit stops when the set time is reached.

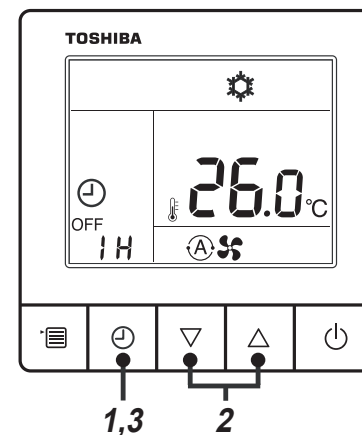

1 OFF timer button

Push the OFF timer button during air conditioning operation.

- "⊙" Push the OFF timer button during air conditioning operation.

2 Select the OFF timer time

Push the setting button to set the time.

- The OFF timer time can be set to 0.5h (30 min), 1h, 2h, ... up to 24h.
- If you do not push any button for 30s, the OFF timer setting will be cancelled.

3 Push the OFF timer button

"SETTING" disappears, the timer indicator changes from flashing to lighting, and the OFF timer starts. The timer indicator on the OFF timer operation is displayed with countdown.

■ Cancelling the timer

1 Push the OFF timer button

The timer indicator disappears.

NOTE

Even if air conditioning is turned on or off with the ON/OFF button during OFF timer operation, the OFF timer operation continues.

5 Maintenance

WARNING

Cleaning the air filter and other parts of the air filter involves dangerous work in high places, so be sure to have a qualified installer or qualified service person to do it. Do not attempt it by yourself.

CAUTION

Do not push buttons with wet hands. Doing so may result in electric shock.

Cleaning the air filters

- When the filter indicator is displayed on the remote controller, clean the air filters. (Only for RBC-AMTU*** and RBC-AMSU*** remote controllers.)
- Clogged filters may lower the cooling and heating performance.

When the unit will not be used for a long time

1. Perform the fan operation for a couple of hours to dry inside.
2. Stop the air conditioner with the remote controller and turn off the circuit breaker.
3. Clean the air filters and reinstall them.

Before the cooling season

Clean the drain pan

- Contact the dealer where you purchased the product. (Drain does not work if the drain pan or vent is clogged. In some cases the drain may overflow and wet the wall or floor. Be sure to clean the drain pan before the cooling season.)

NOTE

For environmental conservation, it is strongly recommended that the indoor and outdoor units of the air conditioner in use be cleaned and maintained regularly to ensure efficient operation of the air conditioner.

When the air conditioner is operated for a long time, periodic maintenance (once a year) is recommended. Furthermore, regularly check the outdoor unit for rust and scratches, and remove them or apply rustproof treatment, if necessary.

As a general rule, when an indoor unit is operated for 8 hours or more daily, clean the indoor unit and outdoor unit at least once every 3 months. Ask a professional for this cleaning / maintenance work.

Such maintenance can extend the life of the product though it involves the owner's expense.

Failure to clean the indoor and outdoor units regularly will result in poor performance, freezing, water leakage, and even compressor failure.

▼ Maintenance List

Part	Unit	Check (visual / auditory)	Maintenance
Heat exchanger	Indoor / outdoor	Dust / dirt clogging, scratches	Wash the heat exchanger when it is clogged.
Fan motor	Indoor / outdoor	Sound	Take appropriate measures when abnormal sound is generated.
Filter	Indoor	Dust / dirt, breakage	<ul style="list-style-type: none"> • Wash the filter with water when it is contaminated. • Replace it when it is damaged.
Fan	Indoor	<ul style="list-style-type: none"> • Vibration, balance • Dust / dirt, appearance 	<ul style="list-style-type: none"> • Replace the fan when vibration or balance is terrible. • Brush or wash the fan when it is contaminated.
Air intake / discharge grilles	Indoor / outdoor	Dust / dirt, scratches	Fix or replace them when they are deformed or damaged.
Drain pan	Indoor	Dust / dirt clogging, drain contamination	Clean the drain pan and check the downward slope for smooth drainage.
Ornamental panel, louvers	Indoor	Dust / dirt, scratches	Wash them when they are contaminated or apply repair coating.
Exterior	outdoor	<ul style="list-style-type: none"> • Rust, peeling of insulator • Peeling / lift of coat 	Apply repair coating.

6 Troubleshooting

Check the points described below before requesting repair.

		Symptom	Cause
It is not a malfunction.	Outdoor unit	<ul style="list-style-type: none"> White, misty, cold air or water comes out Sometimes the noise of air leaking is heard. A noise is heard when the power is turned on. 	<ul style="list-style-type: none"> The fan of the outdoor unit is automatically stopped and defrosting is performed. The solenoid valve works when defrosting starts or stops. The outdoor unit is preparing for running.
	Indoor unit	<ul style="list-style-type: none"> Sometimes a swishing is heard. A clacking sound is heard. Discharged air smells unusual. 	<ul style="list-style-type: none"> When the unit starts running, during operation, or immediately after the unit stops running, a sound such as water flowing may be heard, or the operation sound may become louder for a couple of minutes immediately after the unit starts running. This is the sound of the refrigerant flowing or the dehumidifier draining. This is a sound generated when the heat exchanger or other part expands and contracts slightly due to temperature change. Various smells from the walls, carpet, clothes, cigarette, cosmetics or other things adhere to the air conditioner.
		<ul style="list-style-type: none"> The unit does not run. 	<ul style="list-style-type: none"> Has a blackout occurred? Has the circuit breaker blown? Has the protective device been activated? (The operation indicator and \mathcal{P} on the remote controller are blinking.)
Check again.	The room does not cool down.	<ul style="list-style-type: none"> Is the air intake or discharge of the outdoor unit clogged? Is a door or window open? Is the air filter clogged with dust? Is the air volume set to "LOW"? Or is the operation mode set to "FAN"? Is the setup temperature appropriate? 	

If there is something unusual even after checking the above, stop running the unit, turn off the circuit breaker, and inform the dealer where you purchased the product of the product number and symptom. Do not attempt to repair the unit by yourself as doing so is dangerous. If the check indicator (e.g. \mathcal{E} , \mathcal{F} , \mathcal{H}) is displayed on the remote controller LCD, inform the dealer of its content as well.

If any of the following occur, stop running the unit immediately, turn off the circuit breaker, and contact the dealer where you purchased the product.

- The switch does not work properly.
- The circuit breaker often blows out.
- You unintentionally put a foreign object or water inside.
- The unit cannot be run even after the cause of the protective device activation is removed.
- Other unusual conditions are found.

Confirmation and check

If there is something unusual even after checking the above, stop running the unit, turn off the circuit breaker, and inform the dealer where you purchased the product of the product number and symptom. Do not attempt to repair the unit by yourself as doing so is dangerous. If the check indicator (etc.) is displayed on the wired remote controller LCD, inform the dealer of its content as well.

If the air conditioner fails, the timer off indication will alternately display the check code and the number of faulted indoor unit.

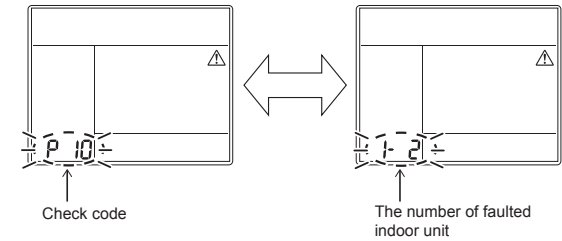

Troubleshooting history and confirmation

If the air conditioner fails, you can view the troubleshooting history by following the steps below. (The troubleshooting history can record at most 4 records.)

The troubleshooting history can be viewed when the air conditioner is on or off.

- If you view the troubleshooting history in the timer off operation, the timer off will be cancelled.

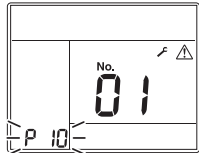
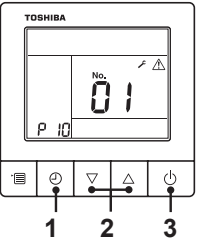
Step	Operation Instructions
1	<p>Long press the timer off button for more than 10 seconds tillan indication icon appears, indicating that you have entered the troubleshooting history mode.</p> <p>If [\mathcal{P} Maintenance overhaul] is displayed, it indicates that you have entered the troubleshooting history mode.</p> <ul style="list-style-type: none"> The temperature indication displays [01: Troubleshooting History Order]. The timer off indication will alternately display [Check Code] and the faulted [Indoor Unit Number]. 
2	<p>Press the set button each time, then the recorded troubleshooting history will be displayed in the order of [01] (newest) to [04] (oldest).</p> <p>REQUIREMENT</p> <p>In the troubleshooting history mode, do not press the menu button for more than 10 seconds. Otherwise, all troubleshooting history of the indoor unit will be deleted.</p> 
3	<p>After completing the check, press the ON/OFF button to return to normal mode.</p> <ul style="list-style-type: none"> It will continue to run if in the running mode. Please press the ON/OFF button again if in the stop mode.

7 Operations and performance

▼ Check before running

- Check whether the earth wire is cut or disconnected.
- Check whether the air filter is installed.
- Turn on the circuit breaker 12 hours or more before starting operation.

▼ 3 minutes protection function

3-minutes protection function prevents the air conditioner from starting for initial 3 minutes after the main power switch / circuit breaker is turned on for restarting the air conditioner.

▼ Power failure

Power failure during operation will stop the unit completely.

- To restart the operation, push the ON/OFF button on the remote controller.
- Lightning or a wireless car telephone operating nearby may cause the unit to malfunction. Turn off the main power switch or circuit breaker and then turn them on again. Push the ON/OFF button on the remote controller to restart.

▼ Defrosting operation

If the outdoor unit is frosted during the heating operation, defrosting starts automatically (for approximately 2 to 10 minutes) to maintain the heating capacity.

- The fans in both indoor and outdoor units will stop during the defrosting operation.
- During the defrosting operation, the defrosted water will be drained from the bottom plate of the outdoor unit.

▼ Heating capacity

In the heating operation, the heat is absorbed from the outside and brought into the room. This way of heating is called heat pump system. When the outside temperature is too low, it is recommended to use another heating apparatus in combination with the air conditioner.

▼ Air conditioner operating conditions

For proper performance, operate the air conditioner under the following temperature conditions:

Cooling operation	Outdoor temperature : -15°C to 46°C (Dry bulb temp.)
	Room temperature : 21°C to 32°C (Dry bulb temp.), 15°C to 24°C (Wet bulb temp.)
	[CAUTION] Room relative humidity – less than 80%. If the air conditioner operates in excess of this figure, the surface of the air conditioner may cause dewing.
Heating operation	Outdoor temperature : -15°C to 15°C (Wet bulb temp.)
	Room temperature : 15°C to 28°C (Dry bulb temp.)

If air conditioner is used outside of the above conditions, safety protection may work.

▼ Protective device

- Stops operation when the air conditioner is overloaded.
- If the protective device is activated, the unit stops running, and the operation indicator and check indicator on the remote controller blink.

▼ If the protective device is activated

- Turn off the circuit breaker and perform a checkup. Continued running may cause a malfunction.
- Check whether the air filter is installed. If not, the heat exchanger may be clogged with dust and water leakage may occur.

▼ During cooling

- The air intake or discharge of the outdoor unit is clogged.
- Strong wind continuously blows against the outlet of the outdoor unit.

▼ During heating

- The air filter is clogged with a large amount of dust.
- The air intake or discharge of the indoor unit is clogged.

▼ Do not turn off the circuit breaker

- During the air-conditioning season, leave the circuit breaker turned on, and use the ON/OFF key on the remote controller.

▼ Attention to snowfall and freeze on the outdoor unit

- In snowy areas, the air intake and air discharge of the outdoor unit are often covered with snow or frozen up. If snow or freeze on the outdoor unit is left as it is, it may cause machine failure or poor warming.
- In cold areas, pay attention to the drain hose so that it perfectly drains water without water remaining inside for freeze prevention. If water freezes in the drain hose or inside the outdoor unit, it may cause machine failure or poor warming.

8 Installation

Do not install the air conditioner in the following places

- Do not install the air conditioner in any place within 1 m from a TV, stereo, or radio set. If the unit is installed in such place, noise transmitted from the air conditioner affects the operation of these appliances.
- Do not install the air conditioner near a high frequency appliance (such as sewing machine or massager for business use), otherwise the air conditioner may malfunction.
- Do not install the air conditioner in a humid or oily place, or in a place where steam, soot, or corrosive gas is generated.
- Do not install the air conditioner in a salty place such as seaside area.
- Do not install the air conditioner in a place where a great deal of machine oil is used.
- Do not install the air conditioner in a place where it is usually exposed to strong wind such as in seaside area.
- Do not install the air conditioner in a place where sulfurous gas generated such as in a spa.
- Do not install the air conditioner in a vessel or mobile crane.
- Do not install the air conditioner in an acidic or alkaline atmosphere (in a hot-spring area or near a chemicals factory, or in a place subject to combustion emissions). Corrosion may be generated on the aluminum fin and copper pipe of the heat exchanger.
- Do not install the air conditioner near an obstacle (such as air vent, lighting equipment) that disturbs discharge air. (Turbulent airflow may reduce the performance or disable devices.)
- Do not use the air conditioner for special purposes such as preserving food, precision instruments, or art objects, or where breeding animals or growing plants are kept. (This may degrade the quality of preserved materials.)
- Do not install the air conditioner over an object that must not get wet. (Condensation may drop from the indoor unit at a humidity of 80% or more or when the drain port is clogged.)
- Do not install the air conditioner in a place where an organic solvent is used.
- Do not install the air conditioner near a door or window subject to humid outside air. Condensation may form on the air conditioner.
- Do not install the air conditioner in a place where special spray is used frequently.

Be careful with noise or vibrations

- Do not install the air conditioner in a place where noise by outdoor unit or hot air from its air discharge annoys your neighbours.
- Install the air conditioner on a solid and stable foundation so that it prevents transmission of resonating, operation noise and vibration.
- If one indoor unit is operating, some sound may be audible from other indoor units that are not operating.

9 Specifications

Model	Sound pressure level (dBA)		Weight (kg)
	Cooling	Heating	
RAV-HM561BTP-E	*	*	23
RAV-HM801BTP-E	*	*	31
RAV-HM901BTP-E	*	*	41
RAV-HM1101BTP-E	*	*	41
RAV-HM1401BTP-E	*	*	41
RAV-HM1601BTP-E	*	*	41

* Under 70 dBA

Product information of ecodesign requirements. (Regulation (EU) 2016/2281)
<http://ecodesign.toshiba-airconditioning.eu/en>

Declaration of Conformity

Manufacturer: Toshiba Carrier (Thailand) Co., Ltd.
 144/9 Moo 5, Bangkadi Industrial Park, Tivanon road, Tambol Bangkadi,
 Amphur Muang, Pathumthani 12000, Thailand

TCF holder: TOSHIBA CARRIER EUROPE S.A.S
 Route de Thil 01120 Montluel FRANCE

Hereby declares that the machinery described below:

Generic Denomination: Air Conditioner

Model/type: RAV-HM561BTP-E,
 RAV-HM801BTP-E,
 RAV-HM901BTP-E,
 RAV-HM1101BTP-E,
 RAV-HM1401BTP-E,
 RAV-HM1601BTP-E

Commercial name: Digital Inverter Series / Super Digital Inverter Series Air Conditioner

Complies with the provisions of the Machinery Directive (Directive 2006/42/EC) and the regulations transposing into national law

Name: Masaru Takeyama
 Position: GM, Quality Assurance Dept.
 Date: 10 May, 2022
 Place Issued: Thailand

NOTE

This declaration becomes invalid if technical or operational modifications are introduced without the manufacturer's consent.

Declaration of Conformity

Manufacturer: Toshiba Carrier (Thailand) Co., Ltd.
144 / 9 Moo 5, Bangkadi Industrial Park, Tivanon Road, Tambol Bangkadi,
Amphur Muang, Pathumthani 12000, Thailand

TCF holder: TOSHIBA CARRIER UK LTD.
Porsham Close Belliver Industrial Estate Roborough Plymouth Devon
PL6 7DB United Kingdom

Hereby declares that the machinery described below:

Generic Denomination: Air Conditioner

Model / type: RAV-HM561BTP-E,
RAV-HM801BTP-E,
RAV-HM901BTP-E,
RAV-HM1101BTP-E,
RAV-HM1401BTP-E,
RAV-HM1601BTP-E

Commercial name: Digital Inverter Series / Super Digital Inverter Series Air Conditioner

Complies with the provisions of the Supply of Machinery (Safety) Regulations 2008

Name: Masaru Takeyama
Position: GM, Quality Assurance Dept.
Date: 10 May, 2022
Place Issued: Thailand

NOTE

This declaration becomes invalid if technical or operational modifications are introduced without the manufacturer's consent.

Toshiba Carrier (Thailand) Co., Ltd.

144 / 9 Moo 5, Bangkadi Industrial Park, Tivanon Road, Tambol Bangkadi, Amphur Muang, Pathumthani 12000, Thailand