

TOSHIBA

AIR CONDITIONER (SPLIT TYPE) Owner's Manual

R32

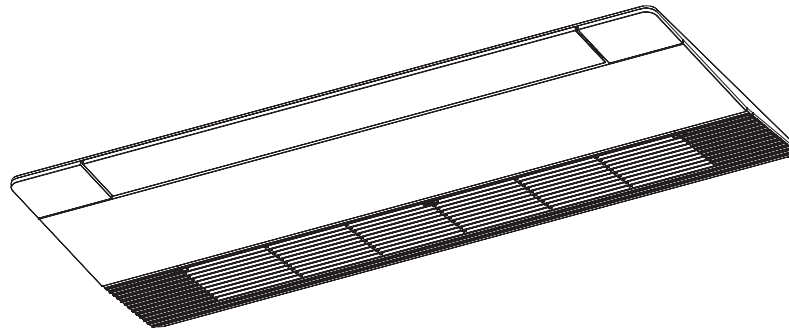

Indoor Unit

For commercial use

Model name:

1-Way Cassette type

RAV-HM301U1TP-E

RAV-HM401U1TP-E

Scan QR CODE to access installation and owner's manual on website.
<https://www.toshiba-carrier.co.th/manuals/default.aspx>

Manual are available in AR/BG/CZ/DA/DE/EL/EN/ES/ET/FI/FR/
HR/HU/IT/LT/LV/NL/NO/PL/PT/RO/RU/SK/SL/SV/TR.



Original instruction

Thank you very much for purchasing TOSHIBA Air Conditioner.
 Please read this owner's manual carefully before using your Air Conditioner.









- Be sure to obtain the "Owner's manual" and "Installation manual" from constructor (or dealer).
 Request to constructor or dealer
- Please clearly explain the contents of the Owner's manual and hand over it.

Contents

1 Part names	2
2 Part names and functions of the remote controller	2
3 Operation.....	3
4 OFF timer operation	4
5 Adjustment of wind direction	5
6 Maintenance.....	6
7 Troubleshooting	7
8 Operations and performance	8
9 Installation.....	8
10 Specifications	9

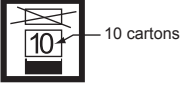
Information on the transportation, handling and storage of the carton

Examples of indication on the carton

Symbol	Description	Symbol	Description
	Keep dry		Do not drop
	Fragile		Do not lay down
	Stacking height (11 cartons can be stacked in this case)		This side up
	Do not step		Handle with care

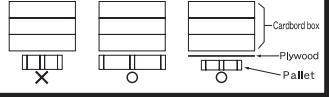
Other cautions	Description
 <div style="border: 1px solid black; padding: 5px; margin-left: 10px;"> <p>Caution</p> <p>Injury possibility. Don't handle with packing band, or may get injured in case of broken band.</p> </div>	<p>CAUTION</p> <p>Injury possibility. Don't handle with packing band, or may get injured in case of broken band.</p>
<div style="border: 1px solid black; padding: 5px;"> <p>Stacking notice.</p> <p>In case that cardboard boxes protrude out of pallet when stacking, lay a 10mm thick plywood over the pallet.</p>  <p>Cardboard box Plywood Pallet</p> </div>	<p>Stacking notice.</p> <p>In case that cardboard boxes protrude out of pallet when stacking. Lay a 10 mm thick plywood over the pallet.</p>

1 Part names

■ Indoor unit

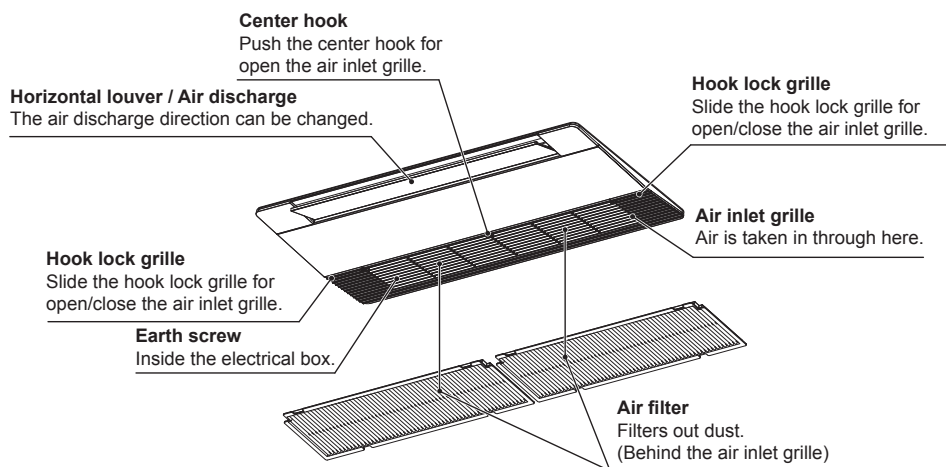

■ Outdoor unit (The design varies depending on the outdoor unit. The following illustration shows an example.)

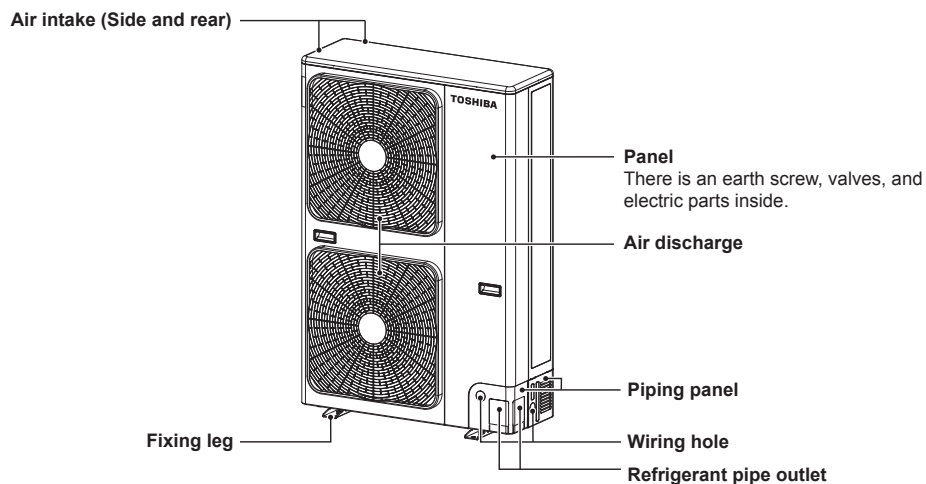

2 Part names and functions of the remote controller

Remote controller model name: RBC-ASCU1*

LCD back-light lights for 15 seconds during remote controller operation.

All indicators are displayed in the display example below.

Actually, only the selected options will be displayed.

■ Operations

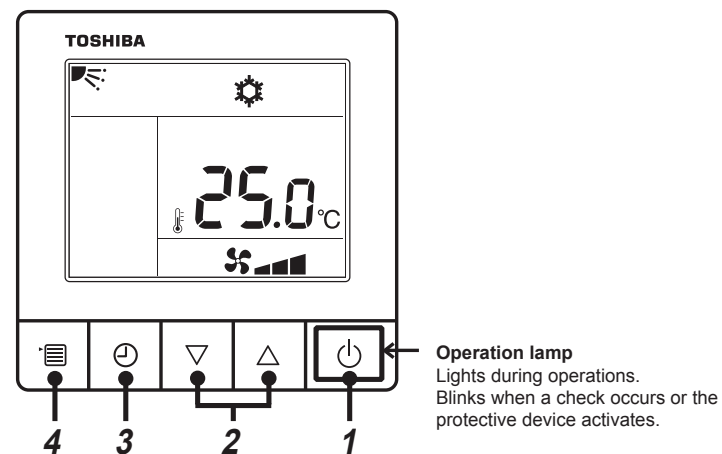

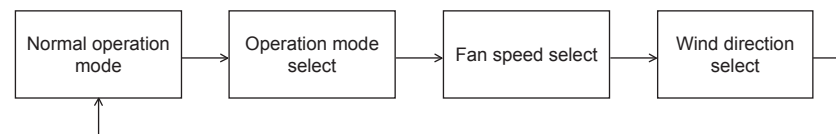

- 1 ON/OFF button**
Turns on the unit when pushed, and turns off when pushed again.
- 2 Setting button**
Sets setting temperature at the normal mode.
Changes each setting at the Operation mode, the Fan speed mode or the Wind direction mode.
- 3 OFF timer button**
Setting the OFF timer.
- 4 Menu button**
Selects the Operation mode select, the Fan speed select or the Wind direction select.
Each time you push the button, indicator is displayed as followings.
 - The Fan speed select or the Wind direction select is not displayed depending on indoor unit models.





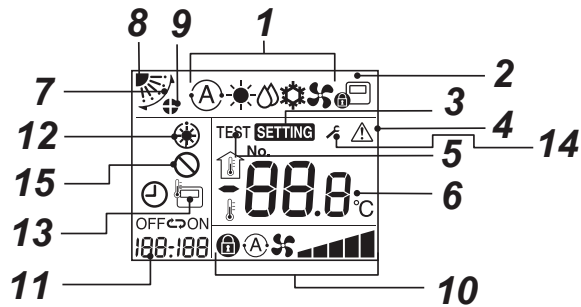



■ Indications

All icons on the display are shown for this explanation. Operations are not accepted when "SETTING" is flashing.



- 1 Operation mode indicator**
Indicates the operation mode selected.
- 2 Central control indicator**
Displayed when the air conditioner is controlled centrally and used with central control devices such as the central remote controller.
If the use of the remote controller is prohibited by the central control,  blinks when the ON/OFF, MODE, or TEMP. button on the remote controller is pushed, and the buttons do not function.
(Settings that can be configured on the remote controller differ depending on the mode of the central control. For details, read the Owner's Manual of the central remote controller.)
- 3 Setting indicator**
Indicates that the model is being checked automatically after a breaker is thrown or some other occurrence.
- 4 Service indicator**
Displayed while the protective device works or a check occurs.
- 5 Test run indicator**
Displayed during test run.
- 6 Temperature setting indicator**
The selected set temperature is displayed.
- 7 Swing indicator**
Displayed during up/down movement of the louver.
- 8 Louver position indicator**
Indicates the louver position.
- 9 Louver lock indicator**
Displayed when there is a louver-locked unit.
- 10 Fan speed indicator**
Indicates the selected fan speed

Auto	
Low	
Low +	
Medium	
Medium +	
High	
Fix	
- 11 OFF timer indicator**
When a trouble occurs, a check code is displayed.
- 12 Pre-heat indicator**
Displayed when the heating mode is energized or defrost cycle is initiated.
While this indication is displayed, the indoor fan stops or operate in fan mode.
- 13 Remote controller sensor indicator**
Displayed while the sensor of the remote controller is used.
- 14 Notice display**
Displayed while notice code occurs.
For details, contact your dealer (distributor).
- 15 No function display**
Displayed when the function requested is not available on that model.

3 Operation

When you use the air conditioner for the first time or change the settings, follow the procedures below. From next time, pushing the ON/OFF button starts running of the air conditioner with the chosen settings.

■ Standby

Operations are not accepted when "SETTING" is blinking.

REQUIREMENT

- Keep the power switch turned on during use.
- When you resume using the air conditioner after a long period of disuse, turn on the power switch at least 12 hours before starting running.
- When the power is turned on, it takes about 1 minute before the remote controller becomes operable.
This is not a malfunction.

■ Running operation

Some operation modes are not available depending on the type of indoor unit.

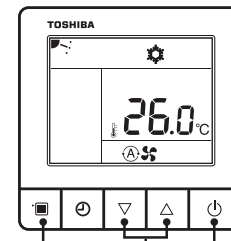

Menu button Setting button ON/OFF button

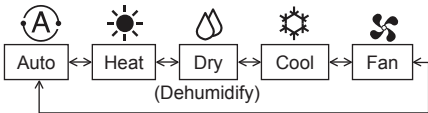
- 1 ON/OFF button**
Push this button to light the operation lamp and start operations.
When heating
 - The heated air comes out after a 3 to 5 minutes of pre-heating with the indoor fan kept turned off.
- 2 Select the operation mode**
Push the Menu button several times to select the operation mode.
 - The current operation mode flashes.
Each time you push the setting button, the operation mode and its icon change in the following order
 - If you do not push any button for 30s, the operation mode finishes.
- 3 Select the fan speed**
Push the Menu button several times to select the fan speed mode.
 - The current fan speed indicator flashes.
Each time you push the setting button, the fan speed mode and its indication change in the following order:
 - A selectable fan speed differs depending on indoor units to be connected.
 - "Auto" cannot be selected at the Fan mode.
 - If you do not push any button for 30s, the fan speed mode finishes.
- 4 Select the temperature**
Push the setting button to adjust the temperature.
 - The temperature setting range is 18.0°C to 29.0°C.
 - The temperature can be set in steps of 0.5°C.

NOTE

Auto Changeover

- When in Auto Mode, the unit selects the operating mode (cooling, heating or fan only) based on the user set point temperature.
- If the Auto mode is uncomfortable, you can select the desired conditions manually.

Cooling

- If there is a demand for cooling, unit will start approximately 1 minute after mode is selected.
- When the room temperature reaches the set temperature, the outdoor unit stops and the indoor unit fan runs at extremely low speed.

Heating

- If there is a demand for heating, unit will start approximately 3 to 5 minutes after the mode is selected.
- After the heating operation has stopped, fan may continue to run for approx. 30 seconds.
- When the room temperature reaches the set temperature, the outdoor unit stops and the indoor unit fan runs at extremely low speed.
- During defrost operation, the fan stops so that cool air is not discharged. ("⊖" Pre-heat is displayed.)

When restarting the operation after stop

When the unit is attempted to restart immediately after it was stopped, the unit can not start for approx. 3 minutes this is to protect the compressor.

■8°C Operation (For object pre-heating)

The air conditioner can control the heating temperature to about 8°C in the heating mode.
The 8°C heating operation requires settings with the wired remote controller. Ask the installer or dealer for the settings according to the installation manual of the indoor unit.

Start

- 1** Set the displayed temperature to 18°C in the heating mode by pushing [▽] setting button.
- 2** Set the displayed temperature to 8°C by pushing [▽] setting button for at least four seconds.

Stop

- 1** Set the displayed temperature to 18°C by pushing [△] setting button.
 - The air conditioner returns to the normal Heat mode. Select a desired temperature and operation mode.

NOTE

- The discharged air temperature is lower than that in the normal heating operation.
- The room temperature may not be heated evenly depending on the remote controller installation location.
- The room temperature may not reach 8°C depending on the room size or the installation conditions.
- Setting for fan speed is available during the 8°C heating operation.
 - The 8°C heating operation is cancelled in the following cases.
 - When operation is stopped with ON/OFF button.
 - When another operation mode is selected.
 - When temperature setting or operation mode is changed or operation is started / stopped by the wireless remote controller or the central control remote controller.
 - When temperature setting or operation mode is changed or operation is started / stopped by the wireless remote controller
- When this operation mode is used, observe proper operating hours and periodic maintenance by service staff is recommended.

4 OFF timer operation

OFF timer: The indoor unit stops when the set time is reached.

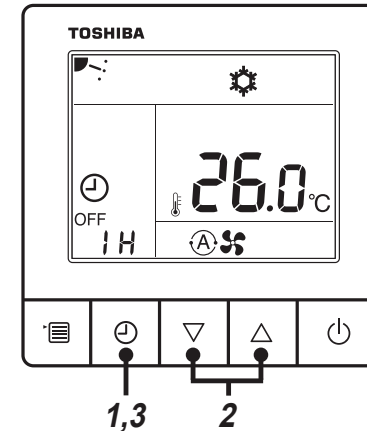

- 1 OFF timer button**
Push the OFF timer button during air conditioning operation.
 - "⊖" and "OFF" light and "SETTING" and timer indicator flash.
- 2 Select the OFF timer time**
Push the setting button to set the time.
 - The OFF timer time can be set to 0.5h (30 min), 1h, 2h, ... up to 24h.
 - If you do not push any button for 30s, the OFF timer setting will be cancelled.
- 3 Push the OFF timer button**
"SETTING" disappears, the timer indicator changes from flashing to lighting, and the OFF timer starts.
 - The timer indicator on the OFF timer operation is displayed with countdown.

■Cancelling the timer

- 1 Push the OFF timer button**
The timer indicator disappears.

NOTE

Even if air conditioning is turned on or off with the ON/OFF button during OFF timer operation, the OFF timer operation continues.

5 Adjustment of wind direction

To improve the cooling / heating performance, change the louver angle for each operation.
Air characteristics: Cool air falls, and warm air rises.

⚠ CAUTION

Point the louver horizontally during cooling
 If pointing downward for cooling, dew may form on the surface of the air discharge or louver and may drop down.

NOTE

- If pointing horizontally for heating, the room temperature may be uneven.
- Do not handle the louver manually. Doing so may cause a failure. Use the remote controller to adjust the angle.

To set the louver direction and auto swing

- 1 Push the Menu button several times and select the wind direction mode to blink the wind direction.
- 2 Push the setting button several times to display the louver direction as shown in the figure below.
 - If you do not push any button for 30s, the wind direction mode finishes.

▼ For heating

The louver can be adjusted to six steps.
 Point the louver downward. If not pointing downward, hot air may not reach the floor.

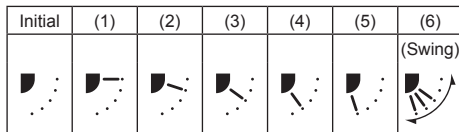

Operation mode	Available directions
HEAT, FAN	(1) ↔ (2) ↔ (3) ↔ (4) ↔ (5) ↔ (6)

▼ For cooling

The louver can be adjusted to four steps.
 Point the louver horizontally. If pointing downward, dew may form on the surface of the air discharge port and may drop down.
 If a louver lock setup is carried out in the position of (1), fan speed will be restricted for prevention of ceiling contamination.

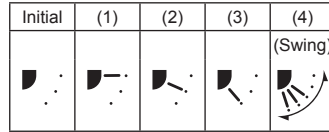

Operation mode	Available directions
COOL, DRY	(1) ↔ (2) ↔ (3) ↔ (4)

▼ For fan

The louver can be adjusted to six steps.
 Select a wind direction.

■ Auto swing

The SWING indicator is displayed and the louver begins swinging.

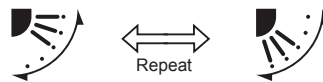

NOTE

- When stopped, the louver closes automatically.
- The louver automatically becomes horizontal or closed at the start of heating operation, defrosting operation, or when the set temperature becomes the same as room temperature. If you set the swing or wind direction at this time, the remote controller display will be the setting, but the louver will not move. When the normal heating operation that blows warm air is started, the louver will be in the set wind direction.
- When the defrosting operation is performed during heating, the louver automatically closes to reduce the cold air falling from the indoor unit.
- If the heating operation is performed less than 12 hours after the circuit breaker is turned on when the outside temperature is low, the louver may automatically close immediately after the start of heating operation to reduce the loss of cold air.

■ Information

The following functions require a connection with the RBC-AMTU*** and RBC-AMSU*** remote controller. For details, consult the dealer where you purchased this product.

- Individual unit selection during group operation
- Individual setting of louver position (wind direction)
- Swing type setting
- Louver lock (no swing) setting

6 Maintenance

WARNING

Cleaning the air filter and other parts of the air filter involves dangerous work in high places, so be sure to have a qualified installer or qualified service person to do it. Do not attempt it by yourself.

CAUTION

Do not push buttons with wet hands. Doing so may result in electric shock.

Cleaning the air filters

- When the filter indicator is displayed on the remote controller, clean the air filters. (Only for RBC-AMTU*** and RBC-AMSU*** remote controllers.)
- Clogged filters may lower the cooling and heating performance.

When the unit will not be used for a long time

- Perform the fan operation for a couple of hours to dry inside.
- Stop the air conditioner with the remote controller and turn off the circuit breaker.
- Clean the air filters and reinstall them.

Before the cooling season

Clean the drain pan

- Contact the dealer where you purchased the product. (Drain does not work if the drain pan or vent is clogged. In some cases the drain may overflow and wet the wall or floor. Be sure to clean the drain pan before the cooling season.)

Check periodically

- If the unit is used for a long time, parts may deteriorate and cause malfunction or bad drainage of dehumidified water depending on the heat, humidity, or dust.
- In addition to the usual maintenance, it is recommended that you have the unit checked and maintained by the dealer where you purchased it.

NOTE

For environmental conservation, it is strongly recommended that the indoor and outdoor units of the air conditioner in use be cleaned and maintained regularly to ensure efficient operation of the air conditioner. When the air conditioner is operated for a long time, periodic maintenance (once a year) is recommended. Furthermore, regularly check the outdoor unit for rust and scratches, and remove them or apply rustproof treatment, if necessary.

As a general rule, when an indoor unit is operated for 8 hours or more daily, clean the indoor unit and outdoor unit at least once every 3 months. Ask a professional for this cleaning / maintenance work. Such maintenance can extend the life of the product though it involves the owner's expense. Failure to clean the indoor and outdoor units regularly will result in poor performance, freezing, water leakage, and even compressor failure.

Maintenance List

Part	Unit	Check (visual / auditory)	Maintenance
Heat exchanger	Indoor / outdoor	Dust / dirt clogging, scratches	Wash the heat exchanger when it is clogged.
Fan motor	Indoor / outdoor	Sound	Take appropriate measures when abnormal sound is generated.
Filter	Indoor	Dust / dirt, scratches	<ul style="list-style-type: none"> Wash the filter with water when it is contaminated. Replace it when it is damaged.
Fan	Indoor	<ul style="list-style-type: none"> Vibration, balance Dust / dirt, appearance 	<ul style="list-style-type: none"> Replace the fan when vibration or balance is terrible. Brush or wash the fan when it is contaminated.
Air intake / discharge grilles	Indoor / outdoor	Dust / dirt, scratches	Fix or replace them when they are deformed or damaged.
Drain pan	Indoor	Dust / dirt clogging, drain contamination	Clean the drain pan and check the downward slope for smooth drainage.
Ceiling panel, louvers	Indoor	Dust / dirt, scratches	Wash them when they are contaminated or apply repair coating.
Exterior	Outdoor	<ul style="list-style-type: none"> Rust, peeling of insulator Peeling / lift of coat 	Apply repair coating.

7 Troubleshooting

Check the points described below before requesting repair.

	Symptom	Cause
It is not a malfunction.	Outdoor unit <ul style="list-style-type: none"> • White, misty, cold air or water comes out • Sometimes the noise of air leaking is heard. • A noise is heard when the power is turned on. 	<ul style="list-style-type: none"> • The fan of the outdoor unit is automatically stopped and defrosting is performed. • The solenoid valve works when defrosting starts or stops. • The outdoor unit is preparing for running.
	Indoor unit <ul style="list-style-type: none"> • Sometimes a swishing is heard. • A clacking sound is heard. • Discharged air smells unusual. • Louvers close automatically during heating 	<ul style="list-style-type: none"> • When the unit starts running, during operation, or immediately after the unit stops running, a sound such as water flowing may be heard, or the operation sound may become louder for a couple of minutes immediately after the unit starts running. This is the sound of the refrigerant flowing or the dehumidifier draining. • This is a sound generated when the heat exchanger, etc. expands and contracts slightly due to temperature change. • Various smells from the walls, carpet, clothes, cigarette, cosmetics, etc. adhere to the air conditioner. <p>In the following cases, the louvers close automatically to reduce the cold air falling from the indoor unit.</p> <ul style="list-style-type: none"> • When defrosting during heating operation. • Immediately after starting heating operation less than 12 hours after turning on the circuit breaker when the outside temperature is low.
It is not a malfunction.	The unit does not run	<ul style="list-style-type: none"> • Has a blackout occurred? • Has the circuit breaker blown? • Has the protective device been activated? (The operation indicator and  on the remote controller are blinking.)
	The room does not cool down or warm up.	<ul style="list-style-type: none"> • Is the air intake or discharge of the outdoor unit clogged? • Is a door or window open? • Is the air filter clogged with dust? • Is the air volume set to "Low"? Or is the operation mode set to "Fan"? • Is the setup temperature appropriate?

If there is something unusual even after checking the above, stop running the unit, turn off the circuit breaker, and inform the dealer where you purchased the product of the product number and symptom. Do not attempt to repair the unit by yourself as doing so is dangerous. If the check indicator (E0, F0, H0, etc.) is displayed on the remote controller LCD, inform the dealer of its content as well.

If any of the following occur, stop running the unit immediately, turn off the circuit breaker, and contact the dealer where you purchased the product.

- The switch does not work properly.
- The circuit breaker often blows out.
- You unintentionally put a foreign object or water inside.
- The unit cannot be run even after the cause of the protective device activation is removed.
- Other unusual conditions are found.

Confirmation and check

If a problem occurs with the air conditioner, the OFF timer indicator alternately shows the check code and the indoor Unit No. in which the problem occurred.

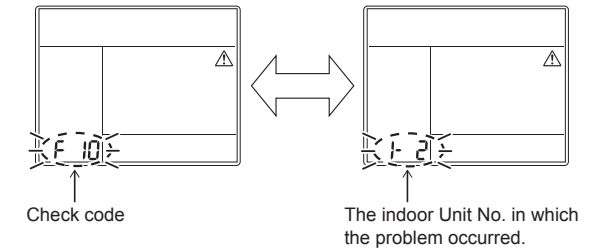

Troubleshooting history and confirmation

You can check the troubleshooting history with the following procedure if a problem occurs with the air conditioner. (The troubleshooting history records up to 4 incidents.)

You can check it during operation or when operation is stopped.

- If you check the troubleshooting history during OFF timer operation, the OFF timer will be cancelled.

Procedure	Description of operation
1	<p>Push the OFF timer button for over 10 seconds and the indicators appear as an image indicating the troubleshooting history mode has been entered.</p> <p>If [ Service check] is displayed, the mode enters in the troubleshooting history mode.</p> <ul style="list-style-type: none"> • [01: Order of troubleshooting history] appears in the temperature indicator. • The OFF timer indicator alternately shows the [check code] and the [indoor Unit No.] in which the problem occurred.
2	<p>Each time the setting button is pushed, the recorded troubleshooting history is displayed in sequence. The troubleshooting history appears in order from [01] (newest) to [04] (oldest).</p> <p>CAUTION</p> <p>In the troubleshooting history mode, DO NOT push the Menu button for over 10 seconds, doing so deletes the entire troubleshooting history of the indoor unit.</p>
3	<p>After you have finished checking, push the ON/OFF button to return to the regular mode.</p> <ul style="list-style-type: none"> • If the air conditioner is operating, it remains operated even after the ON/OFF button has been pushed. To stop its operation, push the ON/OFF button again.

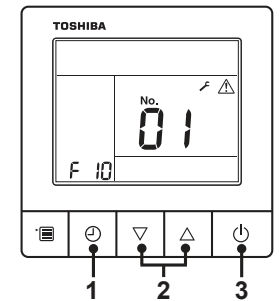
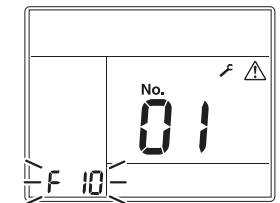

8 Operations and performance

▼ Check before running

- Check whether the earth wire is cut or disconnected.
- Check whether the air filter is installed.
- Turn on the circuit breaker 12 hours or more before starting operation.

▼ 3 minutes protection function

3-minutes protection function prevents the air conditioner from starting for initial 3 minutes after the main power switch / circuit breaker is turned on for restarting the air conditioner.

▼ Power failure

Power failure during operation will stop the unit completely.

- To restart the operation, push the ON / OFF button on the remote controller.
- Lightning or a wireless car telephone operating nearby may cause the unit to malfunction. Turn off the main power switch or circuit breaker and then turn them on again. Push the ON / OFF button on the remote controller to restart.

▼ Defrosting operation

If the outdoor unit is frosted during the heating operation, defrosting starts automatically (for approximately 2 to 10 minutes) to maintain the heating capacity.

- The fans in both indoor and outdoor units will stop during the defrosting operation.
- During the defrosting operation, the fan of the indoor unit / outdoor unit stops and the louver of the indoor unit closes.
- During the defrosting operation, the defrosted water will be drained from the bottom plate of the outdoor unit.

▼ Heating capacity

In the heating operation, the heat is absorbed from the outside and brought into the room. This way of heating is called heat pump system. When the outside temperature is too low, it is recommended to use another heating apparatus in combination with the air conditioner.

▼ Air conditioner operating conditions

For proper performance, operate the air conditioner under the following temperature conditions: Refer to the combined outdoor unit installation manual for details about the outdoor temperature.

Cooling operation	Outdoor temperature	: -15°C to 46°C (Dry bulb temp.)
	Room temperature	: 21°C to 32°C (Dry bulb temp.), 15°C to 24°C (Wet bulb temp.)
	[CAUTION]	Room relative humidity – less than 80%. If the air conditioner operates in excess of this figure, the surface of the air conditioner may cause dewing.
Heating operation	Outdoor temperature	: -15°C to 15°C (Wet bulb temp.)
	Room temperature	: 15°C to 28°C (Dry bulb temp.)

If air conditioner is used outside of the above conditions, safety protection may work.

▼ Protective device

- Stops operation when the air-conditioner is overloaded.
- If the protective device is activated, the unit stops running, and the operation indicator and check indicator on the remote controller blink.

▼ If the protective device is activated

- Turn off the circuit breaker and perform a checkup. Continued running may cause a malfunction.
- Check whether the air filter is installed. If not, the heat exchanger may be clogged with dust and water leakage may occur.

During cooling

- The air intake or discharge of the outdoor unit is clogged.
- Strong wind continuously blows against the discharge of the outdoor unit.

During heating

- The air filter is clogged with a large amount of dust.
- The air intake or discharge of the indoor unit is clogged.

▼ Do not turn off the circuit breaker

- During the air-conditioning season, leave the circuit breaker turned on, and use the ON / OFF key on the remote controller.

▼ Attention to snowfall and freeze on the outdoor unit

- In snowy areas, the air intake and air discharge of the outdoor unit are often covered with snow or frozen up. If snow or freeze on the outdoor unit is left as it is, it may cause machine failure or poor warming.
- In cold areas, pay attention to the drain hose so that it perfectly drains water without water remaining inside for freeze prevention. If water freezes in the drain hose or inside the outdoor unit, it may cause machine failure or poor warming.

9 Installation

Do not install the air conditioner in the following places

- Do not install the air conditioner in any place within 1 m from a TV, stereo, or radio set. If the unit is installed in such place, noise transmitted from the air conditioner affects the operation of these appliances.
- Do not install the air conditioner near a high frequency appliance (sewing machine or massager for business use, etc.), otherwise the air conditioner may malfunction.
- Do not install the air conditioner in a humid or oily place, or in a place where steam, soot, or corrosive gas is generated.
- Do not install the air conditioner in a salty place such as seaside area.
- Do not install the air conditioner in a place where a great deal of machine oil is used.
- Do not install the air conditioner in a place where it is usually exposed to strong wind such as in seaside area.
- Do not install the air conditioner in a place where sulfurous gas generated such as in a spa.
- Do not install the air conditioner in a vessel or mobile crane.
- Do not install the air conditioner in an acidic or alkaline atmosphere (in a hot-spring area or near a chemicals factory, or in a place subject to combustion emissions). Corrosion may be generated on the aluminum fin and copper pipe of the heat exchanger.
- Do not install the air conditioner near an obstacle (air vent, lighting equipment, etc.) that disturbs discharge air. (Turbulent airflow may reduce the performance or disable devices.)
- Do not use the air conditioner for special purposes such as preserving food, precision instruments, or art objects, or where breeding animals or growing plants are kept. (This may degrade the quality of preserved materials.)
- Do not install the air conditioner over an object that must not get wet. (Condensation may drop from the indoor unit at a humidity of 80% or more or when the drain port is clogged.)
- Do not install the air conditioner in a place where an organic solvent is used.
- Do not install the air conditioner near a door or window subject to humid outside air. Condensation may form on the air conditioner.
- Do not install the air conditioner in a place where special spray is used frequently.

Be careful with noise or vibrations

- Do not install the air conditioner in a place where noise by outdoor unit or hot air from its air discharge annoys your neighbors.
- Install the air conditioner on a solid and stable foundation so that it prevents transmission of resonating, operation noise and vibration.
- If one indoor unit is operating, some sound may be audible from other indoor units that are not operating.

10 Specifications

Model	Sound pressure level (dBA)		Weight (kg)
	Cooling	Heating	
RAV-HM301U1TP-E	*	*	13 (4)
RAV-HM401U1TP-E	*	*	13 (4)

* Under 70 dBA

Product information of ecodesign requirements. (Regulation (EU) 2016/2281)
<http://ecodesign.toshiba-airconditioning.eu/en>

Declaration of Conformity

Manufacturer: **TOSHIBA CARRIER (THAILAND) CO., LTD.**
 144 / 9 Moo 5, Bangkadi Industrial Park, Tivanon Road, Tambol Bangkadi,
 Amphur Muang, Pathumthani 12000, Thailand

TCF holder: TOSHIBA CARRIER EUROPE S.A.S
 Route de Thil 01120 Montluel FRANCE

Hereby declares that the machinery described below:

Generic Denomination: Air Conditioner

Model / type: RAV-HM301U1TP-E, RAV-HM401U1TP-E

Commercial name: Digital Inverter Series Air Conditioner

Complies with the provisions of the Machinery Directive (Directive 2006/42/EC) and the regulations transposing into national law

NOTE

This declaration becomes invalid if technical or operational modifications are introduced without the manufacturer's consent.

Declaration of Conformity

Manufacturer: **TOSHIBA CARRIER (THAILAND) CO., LTD.**
 144 / 9 Moo 5, Bangkadi Industrial Park, Tivanon Road, Tambol Bangkadi,
 Amphur Muang, Pathumthani 12000, Thailand

TCF holder: TOSHIBA CARRIER UK LTD.
 Porsham Close Belliver Industrial Estate Roborough Plymouth Devon
 PL6 7DB United Kingdom

Hereby declares that the machinery described below:

Generic Denomination: Air Conditioner

Model / type: RAV-HM301U1TP-E, RAV-HM401U1TP-E

Commercial name: Digital Inverter Series Air Conditioner

Complies with the provisions of the Supply of Machinery (Safety) Regulations 2008

NOTE

This declaration becomes invalid if technical or operational modifications are introduced without the manufacturer's consent.

Warnings on Refrigerant Leakage

Check of Concentration Limit

The room in which the air conditioner is to be installed requires a design that in the event of refrigerant gas leaking out, its concentration will not exceed a set limit.

The refrigerant R32 which is used in the air conditioner is safe, without the toxicity or combustibility of ammonia, and is not restricted by laws to be imposed which protect the ozone layer. However, since it contains more than air, it poses the risk of suffocation if its concentration should rise excessively. Suffocation from leakage of R32 is almost non-existent. With the recent increase in the number of high concentration buildings, however, the installation of multi air conditioner systems is on the increase because of the need for effective use of floor space, individual control, energy conservation by curtailing heat and carrying power etc. Most importantly, the multi air conditioner system is able to replenish a large amount of refrigerant compared with conventional individual air conditioners. If a single unit of the multi conditioner system is to be installed in a small room, select a suitable model and installation procedure so that if the refrigerant accidentally leaks out, its concentration does not reach the limit (and in the event of an emergency, measures can be made before injury can occur).

In a room where the concentration may exceed the limit, create an opening with adjacent rooms, or install mechanical ventilation combined with a gas leak detection device. The concentration is as given below.

$$\frac{\text{Total amount of refrigerant (kg)}}{\text{Min. volume of the indoor unit installed room (m}^3\text{)}} \leq \text{Concentration limit (kg/m}^3\text{)}$$

The concentration limit of R32 which is used in multi air conditioners is 0.3 kg/m³.

▼ NOTE 1

If there are 2 or more refrigerating systems in a single refrigerating device, the amounts of refrigerant should be as charged in each independent device.

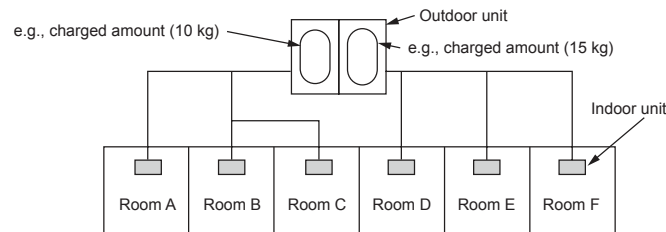

For the amount of charge in this example:

The possible amount of leaked refrigerant gas in rooms A, B and C is 10 kg.

The possible amount of leaked refrigerant gas in rooms D, E and F is 15 kg.

▼ NOTE 2

The standards for minimum room volume are as follows.

- 1) No partition (shaded portion)

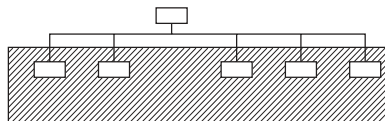

Important

- 2) When there is an effective opening with the adjacent room for ventilation of leaking refrigerant gas (opening without a door, or an opening 0.15% or larger than the respective floor spaces at the top or bottom of the door).

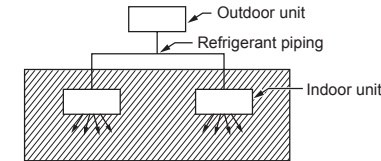

- 3) If an indoor unit is installed in each partitioned room and the refrigerant piping is interconnected, the smallest room of course becomes the object. But when a mechanical ventilation is installed interlocked with a gas leakage detector in the smallest room where the density limit is exceeded, the volume of the next smallest room becomes the object.

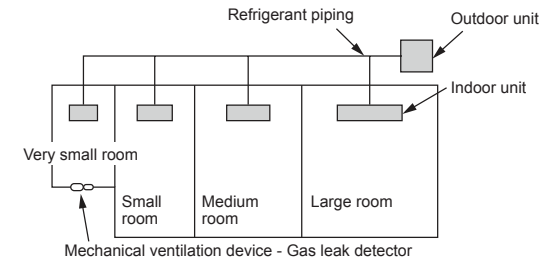

▼ NOTE 3

The minimum indoor floor area compared with the amount of refrigerant is roughly as follows: (When the ceiling is 2.7 m high)

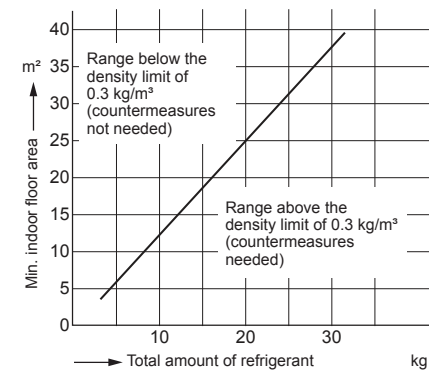

■ Confirmation of indoor unit setup

Prior to delivery to the customer, check the address and setup of the indoor unit, which has been installed in this time and fill the check sheet (Table below). Data of four units can be entered in this check sheet. Copy this sheet according to the No. of the indoor units. If the installed system is a group control system, use this sheet by entering each line system into each Installation Manual attached to the other indoor units.

REQUIREMENT

This check sheet is required for maintenance after installation. Fill this sheet and then pass this Installation Manual to the customers.

Indoor unit setup check sheet

Indoor unit		Indoor unit		Indoor unit		Indoor unit	
Room name	Room name	Room name	Room name	Room name	Room name	Room name	Room name
Model	Model	Model	Model	Model	Model	Model	Model
Check indoor unit address. (For check method, refer to APPLICABLE CONTROLS in this manual.)							
* In case of a single system, it is unnecessary to enter the indoor address. (CODE NO.: Line [12], Indoor [13], Group [14], Central control [03])							
Line	Indoor	Group	Line	Indoor	Group	Line	Indoor
Central control address		Central control address		Central control address		Central control address	
Various setup		Various setup		Various setup		Various setup	
Have you changed high ceiling setup? If not, fill check mark [x] in [NO CHANGE], and fill check mark [x] in [ITEM] if changed, respectively. (For check method, refer to APPLICABLE CONTROLS in this manual.) * In case of replacement of jumper blocks on indoor microcomputer P.C. board, setup is automatically changed.							
High ceiling setup (CODE No. [5d1])	<input type="checkbox"/> NO CHANGE <input type="checkbox"/> STANDARD <input type="checkbox"/> HIGH CEILING 1 <input type="checkbox"/> HIGH CEILING 3	High ceiling setup (CODE No. [5d1])	<input type="checkbox"/> NO CHANGE <input type="checkbox"/> STANDARD <input type="checkbox"/> HIGH CEILING 1 <input type="checkbox"/> HIGH CEILING 3	High ceiling setup (CODE No. [5d1])	<input type="checkbox"/> NO CHANGE <input type="checkbox"/> STANDARD <input type="checkbox"/> HIGH CEILING 1 <input type="checkbox"/> HIGH CEILING 3	High ceiling setup (CODE No. [5d1])	<input type="checkbox"/> NO CHANGE <input type="checkbox"/> STANDARD <input type="checkbox"/> HIGH CEILING 1 <input type="checkbox"/> HIGH CEILING 3
Have you changed filter sign lighting time of filter sign? If not, fill check mark [x] in [NO CHANGE], and fill check mark [x] in [ITEM] if changed, respectively. (For check method, refer to APPLICABLE CONTROLS in this manual.)							
Filter sign lighting time (CODE No. [011])	<input type="checkbox"/> NO CHANGE <input type="checkbox"/> NONE <input type="checkbox"/> 150H <input type="checkbox"/> 2500H <input type="checkbox"/> 5000H <input type="checkbox"/> 10000H	Filter sign lighting time (CODE No. [011])	<input type="checkbox"/> NO CHANGE <input type="checkbox"/> NONE <input type="checkbox"/> 150H <input type="checkbox"/> 2500H <input type="checkbox"/> 5000H <input type="checkbox"/> 10000H	Filter sign lighting time (CODE No. [011])	<input type="checkbox"/> NO CHANGE <input type="checkbox"/> NONE <input type="checkbox"/> 150H <input type="checkbox"/> 2500H <input type="checkbox"/> 5000H <input type="checkbox"/> 10000H	Filter sign lighting time (CODE No. [011])	<input type="checkbox"/> NO CHANGE <input type="checkbox"/> NONE <input type="checkbox"/> 150H <input type="checkbox"/> 2500H <input type="checkbox"/> 5000H <input type="checkbox"/> 10000H
Have you changed detected temp. shift value? If not, fill check mark [x] in [NO CHANGE], and fill check mark [x] in [ITEM] if changed, respectively. (For check method, refer to APPLICABLE CONTROLS in this manual.)							
Detected temp. shift value setup (CODE NO. [06])	<input type="checkbox"/> NO CHANGE <input type="checkbox"/> NO SHIFT <input type="checkbox"/> +1°C <input type="checkbox"/> +2°C <input type="checkbox"/> +3°C <input type="checkbox"/> +4°C <input type="checkbox"/> +5°C <input type="checkbox"/> +6°C	Detected temp. shift value setup (CODE NO. [06])	<input type="checkbox"/> NO CHANGE <input type="checkbox"/> NO SHIFT <input type="checkbox"/> +1°C <input type="checkbox"/> +2°C <input type="checkbox"/> +3°C <input type="checkbox"/> +4°C <input type="checkbox"/> +5°C <input type="checkbox"/> +6°C	Detected temp. shift value setup (CODE NO. [06])	<input type="checkbox"/> NO CHANGE <input type="checkbox"/> NO SHIFT <input type="checkbox"/> +1°C <input type="checkbox"/> +2°C <input type="checkbox"/> +3°C <input type="checkbox"/> +4°C <input type="checkbox"/> +5°C <input type="checkbox"/> +6°C	Detected temp. shift value setup (CODE NO. [06])	<input type="checkbox"/> NO CHANGE <input type="checkbox"/> NO SHIFT <input type="checkbox"/> +1°C <input type="checkbox"/> +2°C <input type="checkbox"/> +3°C <input type="checkbox"/> +4°C <input type="checkbox"/> +5°C <input type="checkbox"/> +6°C
Incorporation of parts sold separately		Incorporation of parts sold separately		Incorporation of parts sold separately		Incorporation of parts sold separately	
Have you incorporated the following parts sold separately? If incorporated, fill check mark [x] in each [ITEM]. (When incorporating, the setup change is necessary in some cases. For setup change method, refer to Installation Manual attached to each part sold separately.)							
<input type="checkbox"/> Others ()	<input type="checkbox"/> Others ()	<input type="checkbox"/> Others ()	<input type="checkbox"/> Others ()	<input type="checkbox"/> Others ()	<input type="checkbox"/> Others ()	<input type="checkbox"/> Others ()	<input type="checkbox"/> Others ()

Toshiba Carrier (Thailand) Co., Ltd.

144 / 9 Moo 5, Bangkadi Industrial Park, Tivanon Road, Tambol Bangkadi, Amphur Muang, Pathumthani 12000, Thailand