

For commercial use

# Touch screen controller

Model Name

---

**BMS-CT2560U-E**  
**(BMS-CT1280TU)**  
**(BMS-CT2560U-TR)**

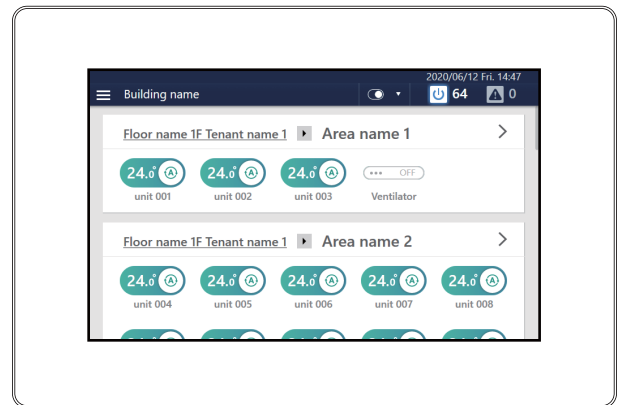

- Thank you for purchasing this System Controller.
- In order to use this product safely and correctly, please read this owner's manual carefully before use and make sure that you fully understand the contents.
- In particular, please be sure to read the "Safety Precautions".
- After reading this manual, be sure to keep it in a place where the operator of the Unit can always view it.

# Contents

---

<b>1 Quick Start Guide</b> .....	<b>6</b>
<b>2 Safety Precautions</b> .....	<b>7</b>
<b>3 Operating Method and Screen Structure</b> .....	<b>9</b>
Touch Panel Operation Method .....	9
Screen Structure .....	10
<b>4 Before Usage</b> .....	<b>11</b>
Air Conditioning System Configurations .....	11
Glossary .....	12
Control Target Devices .....	13
About the Main Screens .....	14
Home (switch screen) .....	14
Screen description .....	14
List screen .....	17
How to display the screen .....	17
Screen description .....	18
Layout screen .....	20
How to display the screen .....	20
Screen description .....	21
Group control screen ([CONTROL] tab) .....	22
How to display the screen .....	22
Screen description .....	23
Individual control screen ([CONTROL] tab) .....	24
How to display the screen .....	24
Screen description .....	25
For the Air to Water Heat Pump (ATW) .....	27
<b>5 Perform Initial Settings</b> .....	<b>29</b>
<b>Unit Settings</b> .....	<b>29</b>
<b>Settings for Remote Monitoring with a PC</b> .....	<b>30</b>
System diagram .....	30
Unit settings .....	30
PC settings .....	30
Settings .....	30
Operating environment .....	30
Install the software .....	32
<b>Setting when Using Energy Report Software 2</b> .....	<b>33</b>
Unit settings .....	33
PC settings .....	33

<b>6 Basic Usage</b>	<b>34</b>
<b>Start/Stop Operation</b>	<b>34</b>
Overall air conditioning system operation method	34
Group unit operation method	36
Operation method in units of air conditioner or ON/OFF unit	37
<b>Change the Air Conditioning Settings</b>	<b>38</b>
Group unit operation method	38
Air conditioner unit operation method	41
<b>Set the Operation Schedule</b>	<b>44</b>
Screen description	44
Group screen	44
Individual control screen	45
Create a new weekly schedule	46
Create a new special day schedule	48
<b>Monitor the Overall Air Conditioning System</b>	<b>50</b>
<b>7 Various Functions</b>	<b>51</b>
<b>Local Remote Controller Lock</b>	<b>51</b>
<b>Set Operation Details</b>	<b>53</b>
Options for air conditioners	54
Options for Air to Water Heat Pump (ATW)	55
Set the wind direction (left / right)	56
Turn ON/OFF the ventilation function	56
Set ventilation mode	56
Setting the ventilation fan speed	56
Check the output status of the air conditioner(s)	57
Check the outdoor temperature detected by the outdoor unit	57
Set humidification	57
Set the CO <sub>2</sub> concentration excess setting	57
Make the night operation setting for the outdoor unit	57
Filter sign Reset	58
Set Soft Cooling	58
Control air conditioner power	58
Set saving operation	58
Release thermo OFF	58
Configure and confirm the Return Back settings	59
Monitor power peak cut of outdoor unit	59
Change to energy saving temperature	59
Frost protection	59
Set the temperature change range	60
HiPower	60
ECO	60
Power Select	61
PURE	61
Fireplace	61

Notice Code .....	61
Check Code (During backup operation) .....	61
Unit information .....	62
Auto mode .....	62
Night set back .....	62
Hot water boost .....	62
Anti bacteria .....	63
ESTIA information .....	63
<b>Change the Operating Schedule .....</b>	<b>64</b>
Change the details of the weekly schedule .....	64
Change the details of the special day schedule .....	66
Setting items list .....	68
Delete the operation schedule .....	71
<b>Confirm the Operation Time .....</b>	<b>72</b>
Group screen .....	73
Individual control screen .....	73
<b>Display the Owner's Manual on the Screen .....</b>	<b>74</b>
How to display the owner's manual .....	74
Owner's manual screen description .....	74
<b>Display the open source software license on the screen .....</b>	<b>75</b>
How to display the open source software license .....	75
<b>8 Administrator Menu .....</b>	<b>76</b>
<b>Confirm Check Code History .....</b>	<b>76</b>
<b>Confirm Notice Code History .....</b>	<b>76</b>
<b>Confirm the Energy Monitor .....</b>	<b>77</b>
Confirm the Real kWh on a graph .....	77
Confirm the estimated kW, capacity, and EER/COP on a graph .....	78
<b>Restrict Operation of the Touch screen controller .....</b>	<b>79</b>
<b>[Functions] Menu Settings .....</b>	<b>80</b>
How to display the [Functions] menu .....	80
Release demand control of outdoor unit .....	80
Set demand control schedule of outdoor unit .....	81
Add/change power peak cut schedule .....	81
Delete a power peak cut schedule .....	83
Restrict operation mode .....	83
Set the operating schedule or the power peak cut schedule .....	83
Output data to a USB flash drive .....	84
Restart the unit .....	84
Exit the system .....	84
<b>[Initial setting] Menu Settings .....</b>	<b>85</b>
How to display the [Initial setting] menu .....	85
Set the screen display .....	86
Set the current date and time .....	86

Set icons of devices other than air conditioners . . . . .	87
Set the screen theme . . . . .	87
Set an account for remote operation . . . . .	88
Add/change user account. . . . .	88
Delete a user account. . . . .	89
Set the operation lock level . . . . .	90
Set the IP address of the Touch screen controller . . . . .	91
Set check code email destination . . . . .	92
Change the area set for an indoor unit. . . . .	93
Set the name of an indoor unit . . . . .	95
Set the area name . . . . .	95
Set the power peak cut for each outdoor or indoor unit . . . . .	96
Set the screen brightness. . . . .	97
Set power consumption control conditions . . . . .	97
<b>9 Remote Monitoring Using a PC . . . . .</b>	<b>101</b>
Log in to Remote Control Software . . . . .	101
Log out from Remote Control Software . . . . .	101
Exit Remote Control Software . . . . .	102
Configure the login settings for multiple system controllers . . . . .	103
Log in to multiple system controllers . . . . .	104
<b>10 Power Distribution . . . . .</b>	<b>105</b>
<b>Power Distribution System Using the Energy Report Software 2     (PC Software) . . . . .</b>	<b>105</b>
How to use the power distribution system . . . . .	106
<b>11 Troubleshooting . . . . .</b>	<b>107</b>
<b>12 Useful Information . . . . .</b>	<b>111</b>
<b>13 Appendix . . . . .</b>	<b>112</b>
<b>Specifications . . . . .</b>	<b>112</b>
Detailed specifications . . . . .	112
Function list . . . . .	113
<b>List by Lock Level/Level . . . . .</b>	<b>115</b>
<b>List of items listed in CSV file . . . . .</b>	<b>117</b>
AVG_(Hour,Day,Month)_IDU_ECalc_(yyyymm,yyyy,ALL).csv . . . . .	117
AVG_(Hour,Day,Month)_ODU_ECalc_(yyyymm,yyyy,ALL).csv . . . . .	117
AVG_(Hour,Day,Month)_WHM_ECalc_(yyyymm,yyyy,ALL).csv . . . . .	117
<b>14 Warranty and After-Sales Service . . . . .</b>	<b>118</b>
<b>About the Warranty . . . . .</b>	<b>118</b>
<b>About After-Sales Service . . . . .</b>	<b>118</b>
Contact for after-sales service . . . . .	118

# 1 Quick Start Guide

## Basic Usage

To start/stop the air conditioner(s)		→ "Start/Stop Operation" (P.34)
To change the set temperature		→ "Change the Air Conditioning Settings" (P.38)
To change the Mode (Cool/Heat/Auto/Dry/Fan)		→ "Change the Air Conditioning Settings" (P.38)
To check whether you have forgotten to turn off the air conditioner(s)	Batch ON/OFF screen	→ "Monitor the Overall Air Conditioning System" (P.50)
To check for current malfunctions	Check code screen	→ "Monitor the Overall Air Conditioning System" (P.50)





## Advanced Usage Please use the following functions as necessary.

To set start/stop timer		→ "Set the Operation Schedule" (P.44)
To configure and confirm the energy saving settings	Return Back	→ "Configure and confirm the Return Back settings" (P.59)
	Eco Temperature Shift	→ "Change to energy saving temperature" (P.59)
	Change Temperature Range	→ "Set the temperature change range" (P.60)
	Save Mode	→ "Control air conditioner power" (P.58)
	Schedule settings	→ "Set the Operation Schedule" (P.44)
	Power peak cut schedule	→ "Set demand control schedule of outdoor unit" (P.81)
To operate the Total Heat Exchange Unit		→ "Turn ON/OFF the ventilation function" (P.56)
To cancel the FILTER Sign after filter cleaning		→ "Filter sign Reset" (P.58)
To connect to a PC that has Energy Report Software 2 installed and display the energy usage and power usage report	Connect to a PC that has Energy Report Software 2 installed and display the energy usage	→ "Setting when Using Energy Report Software 2" (P.33)
	IP Address Setting	→ "Set the IP address of the Touch screen controller" (P.91)
	Output to USB flash drive	→ "Output data to a USB flash drive" (P.84)
	Connect to a PC that has Energy Report Software 2 installed and display the power usage report	→ "Power Distribution System Using the Energy Report Software 2 (PC Software)" (P.105)
To output the daily and monthly report files, the check code files, and the setup files by USB flash drive		→ "Output data to a USB flash drive" (P.84)

# 2 Safety Precautions

This section explains safety precautions you must follow in order to prevent harm to the user and other persons and damage to property.



"Display Description" explains the classification of the degree of harm or damage that may occur if the unit is handled incorrectly, while "Symbol Description" indicates the meanings of symbols.

Display Description		Symbol Description	
 <b>WARNING</b>	Indicates "Content that is expected to result in death or serious injury (*1) to the user in the case of incorrect handling".		⊘ indicates prohibited actions. Specifically prohibited contents are indicated with a picture and/or text in or near the symbol.
 <b>CAUTION</b>	Indicates "Content that is expected to result in minor injury (*2) to the user or damage to property (*3) in the case of incorrect handling".		● indicates instructions which must be followed. The actual contents of the instructions are indicated with a picture and/or text in or near the symbol.





\* 1: Serious injury refers to lasting after effects such as blindness, injury, burns (high temperature / low temperature), electric shock, bone fracture, or poisoning, etc. and injuries that require hospitalization/long-term outpatient treatment.  
 \* 2: Minor injury refers to injuries, burns, or electric shocks, etc. that do not require hospitalization or long-term outpatient treatment.  
 \* 3: Damage to property refers to extended damage related to houses, household goods, livestock, or pets, etc.

## **WARNING**



### Installation Precautions

 Request installation	<b>Ask the dealer from whom you purchased the unit or a professional for installation work.</b> Installation requires specialised technical expertise. If you attempt to perform installation work yourself and perform the work incorrectly, it may cause fire, electric shock, or injury.	 Use specified products	<b>Use a designated TOSHIBA air conditioner.</b> Please use a designated TOSHIBA air conditioner. Using products other than specified may cause fire, electric shock, or water leakage. Also, please ask a professional for installation work.
-------------------------------------------------------------------------------------------------------------	---------------------------------------------------------------------------------------------------------------------------------------------------------------------------------------------------------------------------------------------------------------------------------------------------	---------------------------------------------------------------------------------------------------------------	---------------------------------------------------------------------------------------------------------------------------------------------------------------------------------------------------------------------------------------------------

### Usage Precautions





 Prohibited	<b>Do not operate the switches with wet hands.</b> Doing so may cause electric shock or failure.	 Prohibited	<b>Do not wet the System Controller.</b> Please be careful not to get the System Controller wet.
 Compulsory	<b>Turn off the power if anything is abnormal (burnt odour etc.).</b> Continued use may cause fire or electric shock. Please ask the dealer from whom you purchased the product.	 Compulsory	<b>Do not use a power source other than the specified model.</b> Using a power source other than the specified model may cause fire or failure. Please use 220-240 V AC.

### Relocation/Repair Precautions



 Prohibited	<b>Do not remodel.</b> Doing so may cause fire or electric shock.	 Request	<b>Please ask the dealer from whom you purchased the unit for repair.</b> Faulty repair may cause fire or electric shock.
 Request relocation	<b>Contact a specialist or the dealer from whom you purchased the unit to relocate and re-install the air conditioner.</b> Faulty installation may cause fire, electric shock or injury.		

**⚠ CAUTION**

**Installation Precautions**

 Check the installation location	<p><b>Do not install in areas with high humidity or vibration.</b>                  Doing so may cause a failure.</p>	 Check the installation location	<p><b>Do not install in direct sunlight or near heat sources.</b>                  Doing so may cause a failure.</p>
 Check the installation location	<p><b>Do not install in areas where noise is generated.</b>                  Doing so may cause malfunction.</p>	 Check the installation location	<p><b>Do not install this product in a place where combustible gas may leak.</b>                  Gas leaking and accumulating around the product may cause a fire.</p>
 Check the installation location	<p><b>Do not use this device in locations where children may be present.</b></p>		

**Usage Precautions**

 Prohibited	<p><b>Do not drop the product or apply strong shock.</b>                  Doing so may cause a failure.</p>	 If anything is abnormal turn off the power	<p><b>If this product malfunctions, turn off the original power supply, and then contact the dealer from whom you purchased the product to ask for repair.</b>                  Continued operation with an abnormality may cause fire or electric shock.</p>
 Instructions	<p><b>When cleaning and checking, turn off the earth leakage breaker.</b>                  Failing to do so may cause injury.</p>		

**Precautions on Connection to External Devices**

 Prohibited	<p><b>Do not connect the System Controller to the Internet.</b>                  Never connect it. We shall assume no responsibility for any problems arising from the connection. Only a connection to the local area is possible.</p>
---------------------------------------------------------------------------------------------------	---------------------------------------------------------------------------------------------------------------------------------------------------------------------------------------------------------------------------------------------



# 3 Operating Method and Screen Structure

## Touch Panel Operation Method

Explains the basic touch panel operation method.

### **Tap**

Touch your finger lightly on the screen and release it immediately.

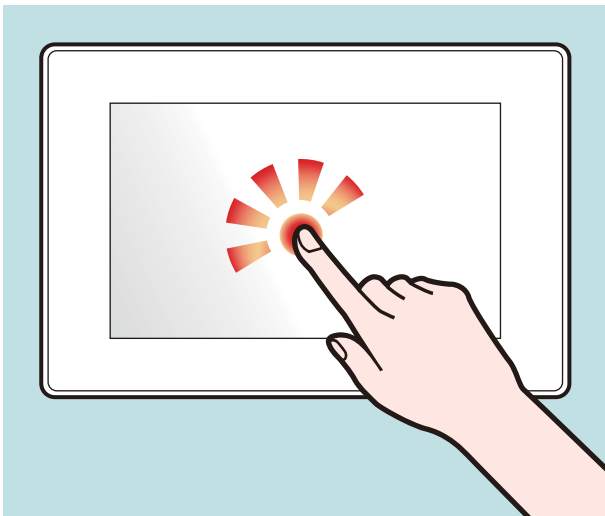

### **Drag**

Tap an object on the screen, hold your finger down, and move.

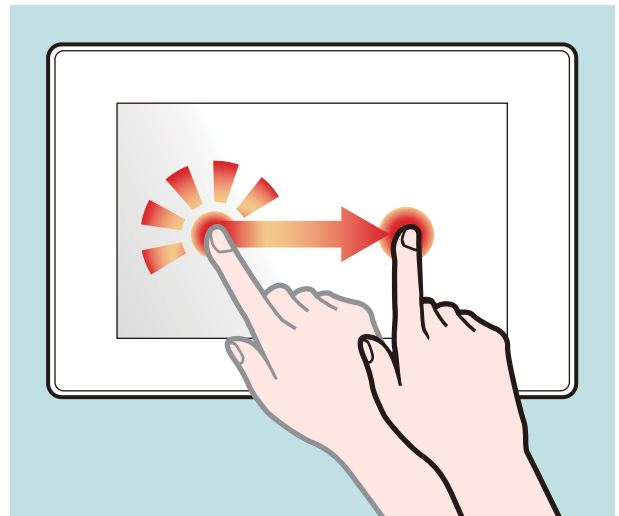

### **Swipe**

Touch your finger lightly on the screen and move it in the desired direction.

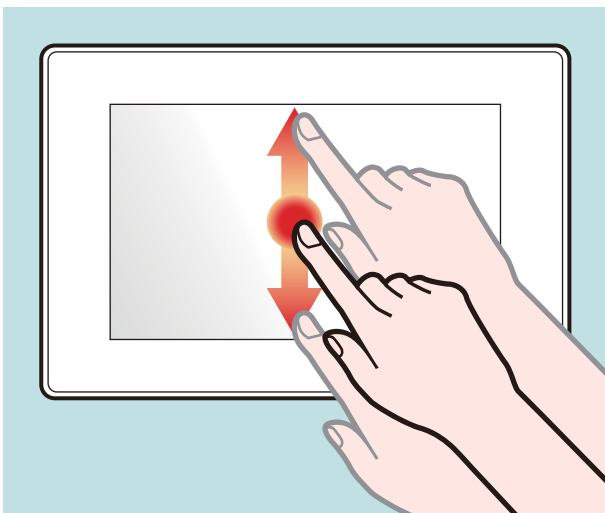

### **Flick**

Touch the screen with your finger and move your finger quickly up, down, to left or the right.

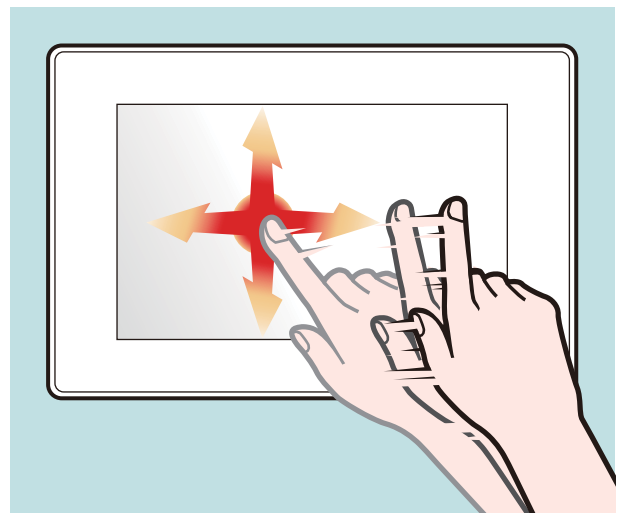

# Screen Structure

The main screen structures used by this Unit are as follows. The screen can be switched by tapping (or flicking in some cases).

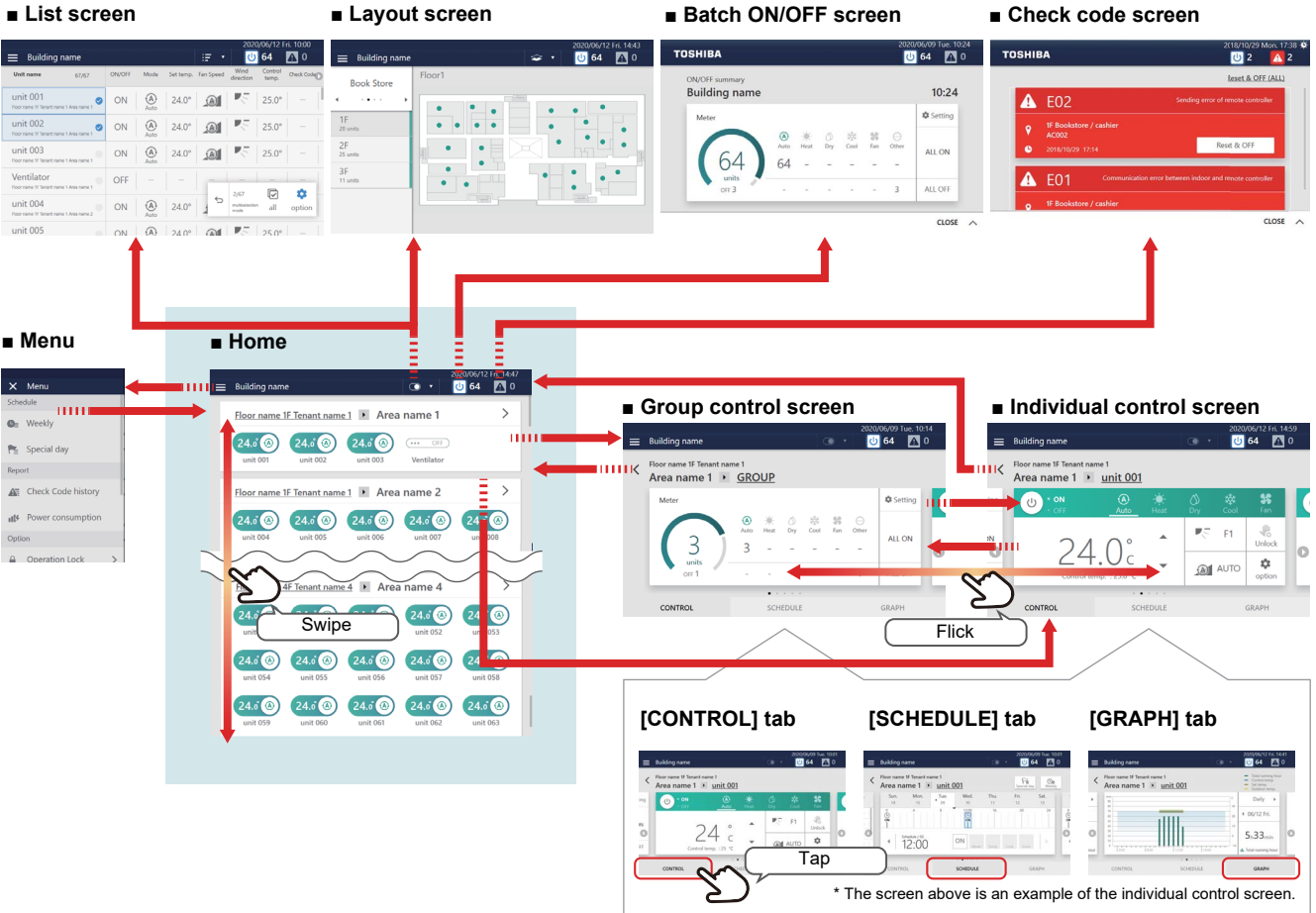

Each screen shows a display example. The display content may vary with the usage environment settings.

Home screen	You can check the operation status of the air conditioner(s) and ON/OFF unit in a list. You can also start/stop individual operation. (P.14)	
List screen	You can check the operation status of the air conditioner(s) and ON/OFF equipment in a list. You can start and stop operation and configure the basic settings. (P.17)	
Layout screen	You can check the operation status of the air conditioner(s) and ON/OFF equipment in a layout. You can also start and stop individual operations. (P.20)	
Group screen	You can check/change the settings in group units. The group screen consists of three tabs: "CONTROL", "SCHEDULE" and "GRAPH". (P.22)	
Individual control screen	You can check/change the settings of the air conditioner(s) and ON/OFF unit individually. The individual control screen consists of three tabs: "CONTROL", "SCHEDULE" and "GRAPH". (P.24)	
Batch ON/OFF screen	You can check the operation status of the whole air conditioning system numerically. You can also start/stop the operation of the whole air conditioning system and configure the detailed settings. (P.50)	
Check code screen	You can confirm check codes that are occurring in the whole air conditioning system in a list. (P.50)	
[CONTROL] tab	You can check the detailed operation status. You can change the settings such as ON/OFF. (P.34)	
[SCHEDULE] tab	You can control the Weekly schedule and the Special day schedule. (P.46)	
[GRAPH] tab	Group screen	You can check the operation time in group units. (P.73)
	Individual control screen	You can check the operation time in air conditioner or ON/OFF unit in units. (P.73)
Menu	You can configure settings for administrators such as screen display change and demand control. (P.76)	

# 4 Before Usage

## Air Conditioning System Configurations

The system configurations that this Unit can control are as follows:

<b>All</b>
Set all air conditioners at once.

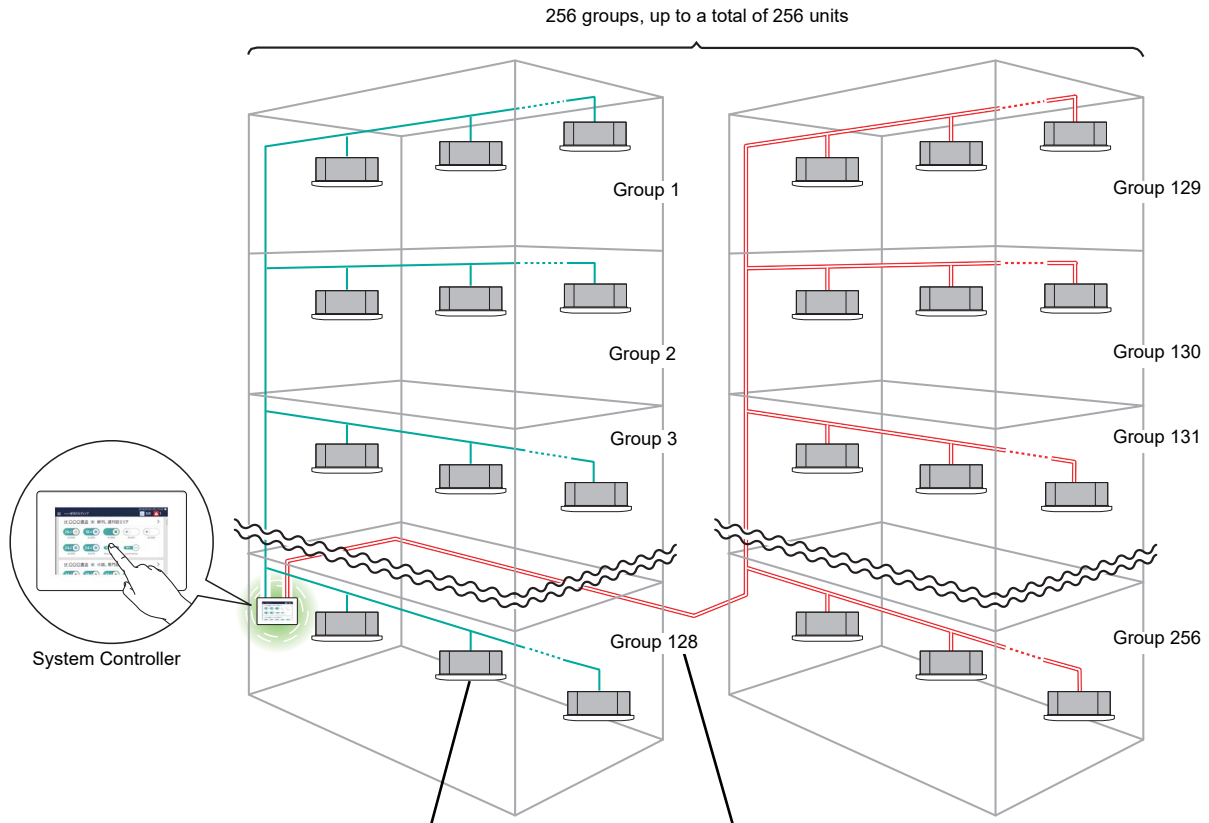

<b>Unit</b>
Set the air conditioners individually.

<b>Group</b>
All air conditioners and ON/OFF unit are divided into 1 to 256 groups, and settings are configured for each group at once.

- There are three units that can be controlled: All, Group, and Unit.
- The maximum number of groups (Floor, Tenant, and Area combinations) that can be controlled is 256.
- The maximum number of units (air conditioners and ON/OFF units) that can be controlled is 256 for air conditioners and 60 for ON/OFF units. \*
- \* The maximum number of air conditioners may change depending on the model combination.

## Glossary

Terminology	Description
Thermo off	When the temperature of a room reaches the set temperature, the outdoor unit compressor stops to switch from cooling/heating to fan operation. Although the indoor unit (air conditioner) is in operation, the outdoor unit repeatedly turns ON/OFF depending on the room temperature.
During power peak cut control	Control to cut the peak of electric power usage.
Flap	A part that changes the air direction at the outlet. It is also called a louver.
Air to Water Heat Pump	This model can control water heating and air conditioning. This model is only available outside the country. It is described as ATW or ESTIA in some parts of the manual.
Room Air Conditioner (home) (RAC)	This is a household air conditioner. It can be connected to a unit via specialized equipment. It is described as RAC in some parts of the manual.
ON/OFF unit	Indicates devices that cannot control or monitor the set temperature or operation mode among the managed devices. Main equipment includes air to air heat exchangers, ventilation fans, etc.
Leak detector (LD)	Refrigerant leak detector This can be displayed on the layout screen for units. If you want to display it, you need to set it in the Section Configuration Software. For details, refer to the manual for the Section Configuration Software. It is described as LD in some parts of the manual.
FS unit	This device controls refrigerant This can be displayed on the layout screen for units. If you want to display it, you need to set it in the Section Configuration Software. For details, refer to the manual for the Section Configuration Software.
RC	It is an abbreviation for "Remote Controller".
SFC2	PC Application Setting File Creation Software 2 (for service personnel)
IDU	Indoor unit
ODU	Outdoor unit
WHM	Power meter, watthour meter

## Control Target Devices

In this Unit, the following devices can be controlled and monitored.

Names of equipment described in this manual	Equipment	Maximum number of units that can be connected
Air conditioner  Can control air conditioning (cooling and heating operations)	Multi air conditioners for buildings (Ceiling cassette, ceiling embedded, ceiling hanging, air to air heat exchanger with coil, etc.)	Total of 256 units
	Light Commercial	
	Package air conditioners for facilities	
	Hot Water Module (* For use outside Japan only)	
	DX-Coil Interface TA type / TF type (* For use outside Japan only)	
	Air to Water Heat Pump (ATW) (* For use outside Japan only)	
ON/OFF unit  Can turn operations ON/OFF	Room Air Conditioner (home) (RAC TU2C-LINK I/F connection * For use outside Japan only)	Total of 60 units
	Room Air Conditioner (home) (ON-OFF control interface connection * For use inside Japan only)	
	Air to Air Heat Exchanger	
	General purpose device control interface	
	DX-Coil Interface DDC type (* For use outside Japan only)	
	External device (DI/DO) (Lighting, ventilation fan, etc.)	

### ● NOTE

The equipment that can be displayed may vary depending on the country or region. For details contact our sales personnel.

## About the Main Screens

This section explains the home screen, list screen, layout screen, and the [CONTROL] tabs of the group screen and the individual control screen.

**NOTE**

Depending on the language settings and the theme settings, the screen languages and display colours differ. The screens shown in the manual use the "English" display setting and the "Type A" theme setting. For details of the display settings, refer to "Set the screen display" (P.86) and for details of the theme settings, refer to "Set the screen theme" (P.87).



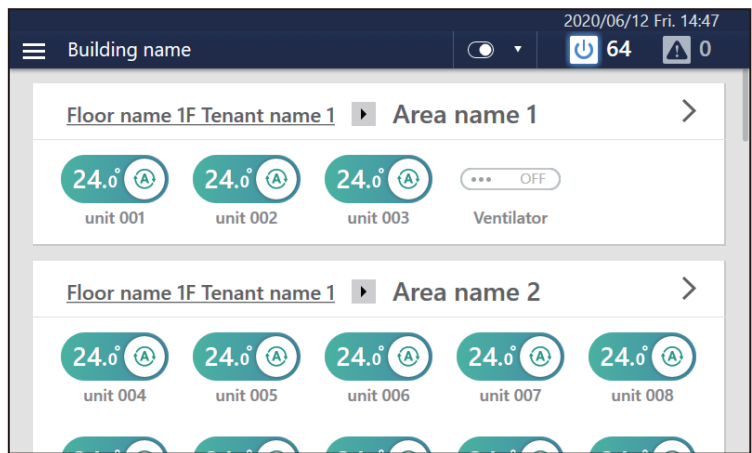





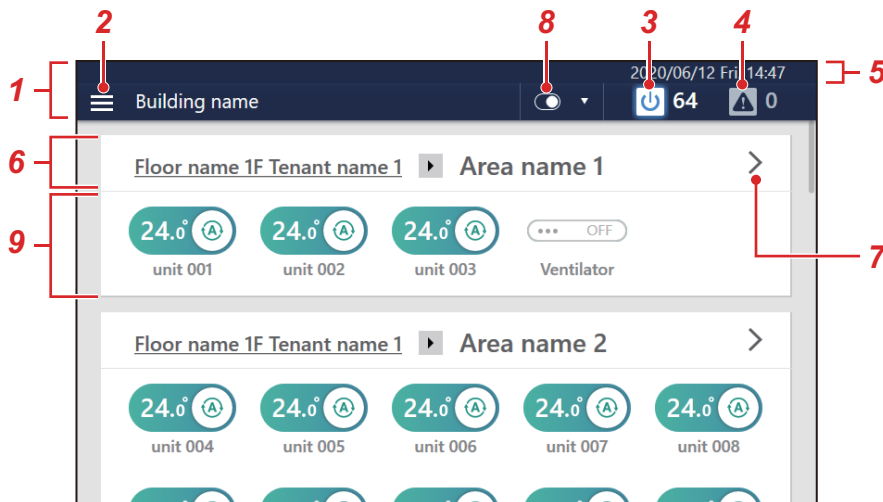

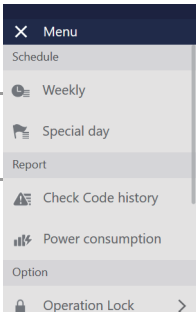





### Home (switch screen)









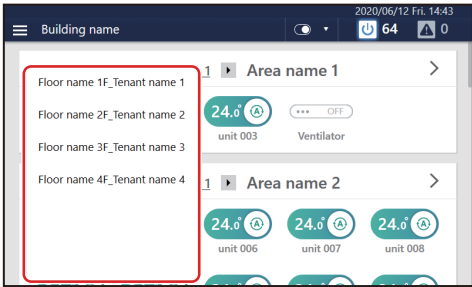















































### Screen description

Switches for all air conditioners and ON/OFF unit are displayed for each group. You can change the group displayed by scrolling the screen.



No.	Name (Icon)	Functions										
1	Header area	It is displayed even on screens other than the home screen. The operation content is common to each screen.										
2	Menu button (☰)	<p>Tap to display the menu. You can display various reports and detailed settings for the Unit.</p> <p><b>NOTE</b></p> <p>The display content of the menu may partially differ depending on the conditions.</p> 										
3	ON/OFF meter button (🔌🔌)	Tap to display the batch ON/OFF screen. (P.50) Lights up when there is an air conditioner or ON/OFF unit in operation.										
4	Check Code button (🚨🚨)	Lights up red when a malfunction has been detected. (P.50) Tap to display the check code screen.										
5	Status display section	<p>Displays the current date and time. Also, the following will be displayed depending on the status and settings of the air conditioning system.</p> <table border="1"> <tr> <td></td> <td>Displays when a demand signal is detected.</td> </tr> <tr> <td></td> <td>Displays during demand control of an outdoor unit. (P.81)</td> </tr> <tr> <td></td> <td>Displays when you operate remotely from a computer. (P.101)</td> </tr> <tr> <td></td> <td>Displays while outputting data to a USB flash drive. (P.84)</td> </tr> <tr> <td></td> <td>Displays when the daylight saving time (summer time) setting is ON. (P.86)</td> </tr> </table>		Displays when a demand signal is detected.		Displays during demand control of an outdoor unit. (P.81)		Displays when you operate remotely from a computer. (P.101)		Displays while outputting data to a USB flash drive. (P.84)		Displays when the daylight saving time (summer time) setting is ON. (P.86)
	Displays when a demand signal is detected.											
	Displays during demand control of an outdoor unit. (P.81)											
	Displays when you operate remotely from a computer. (P.101)											
	Displays while outputting data to a USB flash drive. (P.84)											
	Displays when the daylight saving time (summer time) setting is ON. (P.86)											
6	Group name display section	<p>Displays the name of the group that displays the switch (the name of the group to which the displayed switch belongs). Tap the underlined name in the group name to display the drop-down menu. You can jump to other groups.</p> 										
7	FORWARD button ( > )	Tap to display the group screen. (P.22)										
8	Screen switching button	Switches the display between the home screen (switch screen), list screen, and layout screen.										

No.	Name (Icon)	Functions																										
9	Switch	<p>The air conditioner or ON/OFF unit switch registered in each group is displayed, and the name is displayed below the switch.</p> <table border="1"> <tr> <td data-bbox="644 349 788 636">  </td> <td data-bbox="788 349 1452 636"> <p>Displays the operation status of the air conditioner(s).</p> <p> means operating state. The set temperature is displayed on the left and the operation mode is displayed on the right. Drag or flick  to the left to stop the operation.</p> <p> is the stopped state. Only the set operation mode is displayed. Drag or flick  to the right to start the operation.</p> <p>Tap the overall switch to switch to the [CONTROL] tab on the individual control screen. (P.24)</p> </td> </tr> <tr> <td data-bbox="644 636 788 770">  </td> <td data-bbox="788 636 1452 770"> <p>This is the switch for the Air to Water Heat Pump (ATW). If the Air to Water Heat Pump (ATW) has an air conditioning function, then the air conditioning can be turned on or off.</p> </td> </tr> <tr> <td data-bbox="644 770 788 860">  </td> <td data-bbox="788 770 1452 860"> <p>This is the switch for the Air to Water Heat Pump (ATW) of just the hot water supply function. This switch cannot be operated.</p> </td> </tr> <tr> <td data-bbox="644 860 788 994">  </td> <td data-bbox="788 860 1452 994"> <p>Displays the operating condition of the air conditioner. Operation of the air conditioner(s) is locked. (P.79)</p> </td> </tr> <tr> <td data-bbox="644 994 788 1128">  </td> <td data-bbox="788 994 1452 1128"> <p>Shows the operating status of the Air to Water Heat Pump (ATW). Operation of the Air to Water Heat Pump (ATW) is locked. (P.79)</p> </td> </tr> <tr> <td data-bbox="644 1128 788 1218">  </td> <td data-bbox="788 1128 1452 1218"> <p>A malfunction in progress. Tap to switch to the [CONTROL] tab on the individual control screen and check the details of the check code. (P.28)</p> </td> </tr> <tr> <td data-bbox="644 1218 788 1285">  </td> <td data-bbox="788 1218 1452 1285"> <p>Operation is impossible due to power outage (hibernation state).</p> </td> </tr> <tr> <td data-bbox="644 1285 788 1420">  </td> <td data-bbox="788 1285 1452 1420"> <p>Displays the operation status of the ON/OFF unit. Drag  left or right to change the operation status.</p> </td> </tr> <tr> <td data-bbox="644 1420 788 1509">  </td> <td data-bbox="788 1420 1452 1509"> <p>Displays the operation status of the ON/OFF unit. The operation status cannot be changed. The Unit is locked or output control cannot be performed.</p> </td> </tr> <tr> <td data-bbox="644 1509 788 1599">  </td> <td data-bbox="788 1509 1452 1599"> <p>Displayed when the FILTER Sign appears.</p> </td> </tr> <tr> <td data-bbox="644 1599 788 1688">  </td> <td data-bbox="788 1599 1452 1688"> <p>Displayed during operation preparation.</p> </td> </tr> <tr> <td data-bbox="644 1688 788 1778">  </td> <td data-bbox="788 1688 1452 1778"> <p>Displayed during heating preparation.</p> </td> </tr> <tr> <td data-bbox="644 1778 788 1908">  </td> <td data-bbox="788 1778 1452 1908"> <p>Displayed when the output of the air conditioner is limited.</p> </td> </tr> </table>		<p>Displays the operation status of the air conditioner(s).</p> <p> means operating state. The set temperature is displayed on the left and the operation mode is displayed on the right. Drag or flick  to the left to stop the operation.</p> <p> is the stopped state. Only the set operation mode is displayed. Drag or flick  to the right to start the operation.</p> <p>Tap the overall switch to switch to the [CONTROL] tab on the individual control screen. (P.24)</p>		<p>This is the switch for the Air to Water Heat Pump (ATW). If the Air to Water Heat Pump (ATW) has an air conditioning function, then the air conditioning can be turned on or off.</p>		<p>This is the switch for the Air to Water Heat Pump (ATW) of just the hot water supply function. This switch cannot be operated.</p>		<p>Displays the operating condition of the air conditioner. Operation of the air conditioner(s) is locked. (P.79)</p>		<p>Shows the operating status of the Air to Water Heat Pump (ATW). Operation of the Air to Water Heat Pump (ATW) is locked. (P.79)</p>		<p>A malfunction in progress. Tap to switch to the [CONTROL] tab on the individual control screen and check the details of the check code. (P.28)</p>		<p>Operation is impossible due to power outage (hibernation state).</p>		<p>Displays the operation status of the ON/OFF unit. Drag  left or right to change the operation status.</p>		<p>Displays the operation status of the ON/OFF unit. The operation status cannot be changed. The Unit is locked or output control cannot be performed.</p>		<p>Displayed when the FILTER Sign appears.</p>		<p>Displayed during operation preparation.</p>		<p>Displayed during heating preparation.</p>		<p>Displayed when the output of the air conditioner is limited.</p>
	<p>Displays the operation status of the air conditioner(s).</p> <p> means operating state. The set temperature is displayed on the left and the operation mode is displayed on the right. Drag or flick  to the left to stop the operation.</p> <p> is the stopped state. Only the set operation mode is displayed. Drag or flick  to the right to start the operation.</p> <p>Tap the overall switch to switch to the [CONTROL] tab on the individual control screen. (P.24)</p>																											
	<p>This is the switch for the Air to Water Heat Pump (ATW). If the Air to Water Heat Pump (ATW) has an air conditioning function, then the air conditioning can be turned on or off.</p>																											
	<p>This is the switch for the Air to Water Heat Pump (ATW) of just the hot water supply function. This switch cannot be operated.</p>																											
	<p>Displays the operating condition of the air conditioner. Operation of the air conditioner(s) is locked. (P.79)</p>																											
	<p>Shows the operating status of the Air to Water Heat Pump (ATW). Operation of the Air to Water Heat Pump (ATW) is locked. (P.79)</p>																											
	<p>A malfunction in progress. Tap to switch to the [CONTROL] tab on the individual control screen and check the details of the check code. (P.28)</p>																											
	<p>Operation is impossible due to power outage (hibernation state).</p>																											
	<p>Displays the operation status of the ON/OFF unit. Drag  left or right to change the operation status.</p>																											
	<p>Displays the operation status of the ON/OFF unit. The operation status cannot be changed. The Unit is locked or output control cannot be performed.</p>																											
	<p>Displayed when the FILTER Sign appears.</p>																											
	<p>Displayed during operation preparation.</p>																											
	<p>Displayed during heating preparation.</p>																											
	<p>Displayed when the output of the air conditioner is limited.</p>																											



## List screen

Building name		2020/06/12 Fri. 09:59						
Unit name	67/67	ON/OFF	Mode	Set temp.	Fan Speed	Wind direction	Control temp.	Check Code
unit 001 Floor name 1F Tenant name 1 Area name 1		ON	Auto	24.0°			25.0°	—
unit 002 Floor name 1F Tenant name 1 Area name 1		ON	Auto	24.0°			25.0°	—
unit 003 Floor name 1F Tenant name 1 Area name 1		ON	Auto	24.0°			25.0°	—
Ventilator Floor name 1F Tenant name 1 Area name 1		OFF	—	—	—	—	—	—
unit 004 Floor name 1F Tenant name 1 Area name 2		ON	Auto	24.0°			25.0°	—
unit 005		ON	Auto	24.0°			25.0°	—

### How to display the screen



- 1 From the home screen, tap . A pulldown menu appears.

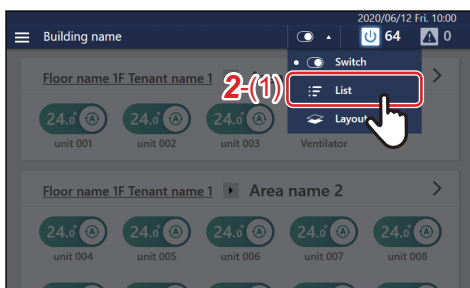

- 2 Tap [2-(1)]. The list screen appears.

**Screen description**

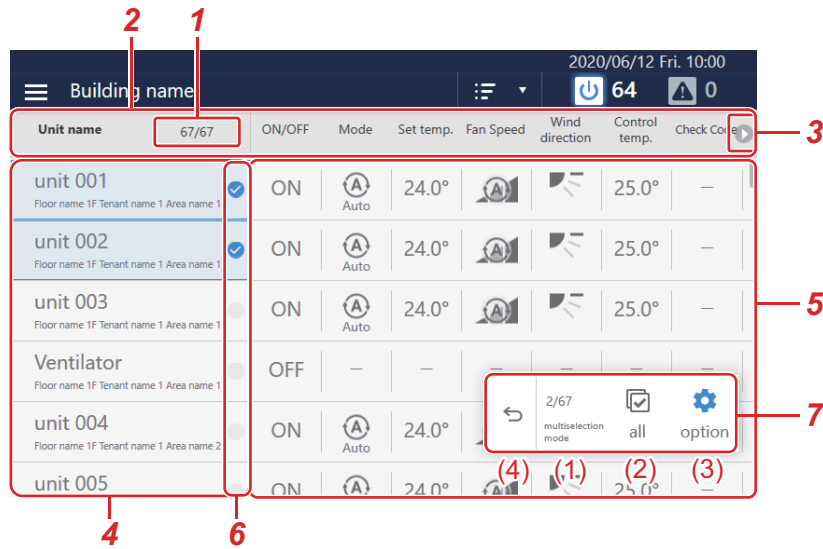

No.	Name (Icon)	Functions
1	Filter button	Tap to display the unit selection screen. You can select the units to display on the unit selection screen.
2	List title	Displays the title of each list. Tap the title to sort the items in ascending order. Tap it again to sort the items in descending order.
3	Display switching button	Moves you to the right page to display the hidden list items.
4	Unit name list	Displays unit names. Under a unit name, group name of that unit is displayed.
5	Unit status list	Displays the status of each unit on a display item-by-display item basis. For an item without a function, a "-" is displayed.
6	Check box for collective setting	Enables you to select a unit subject to collective setting. Each time you tap it, the unit is selected/deselected.
7	Multiselection mode	Displayed if you select the check box for collective setting, so that you can set multiple units. If you tap another check box for collective setting while multiselection mode is displayed, the unit(s) will be added to the units subject to collective setting.  (1) multiselection mode: Displays the number of selected units. (2) all: Each time you tap it, all the units in the group are selected or deselected. (3) option: Opens the collective setting change screen. (4) ↩ : Exits multiselection mode.

**List of functions shown on the list screen**

List display function	
ON/OFF	
Mode	
Set temp.	
Fan Speed	
Wind direction (up / down)	
Control temp.	
Inspection & Notification	
Lock setting of remote control	ON/OFF
	Mode
	Set temp.
Wind direction (left / right)	
Filter sign reset	
Remote-less	
Preparing	
Power Level	
Energy saving ratio[%]	
Saving operation	
Soft Cooling	
Return Back	
Outdoor temp.	
Night operation	
Power peak cut	
Forced Thermo OFF	
PURE	
Ventilation	ON/OFF
	Mode
	Fan Speed
	24-hour ventilation
	Nighttime heat purge
Control of Temperature Range Setting	Auto
	Heat
	Cool
	Dry

List display function
DHW ON/OFF
Auto mode
Frost protection
Anti bacteria
Night set back
Hot water boost
HiPower
ECO
Power Select
Fireplace
Night operation (RAC)
LD Sensor NG
FS Blocking
FS Out of battery
Stirring operation
Humidity
Humidification setting
CO <sub>2</sub> concentration
Excessive CO <sub>2</sub> setting
PM2.5 concentration

## Layout screen

**NOTE**

- This function is displayed only when the layout screen is registered.
- For details on how to configure the layout screen, refer to the Operating Instructions of the Section Configuration Software.

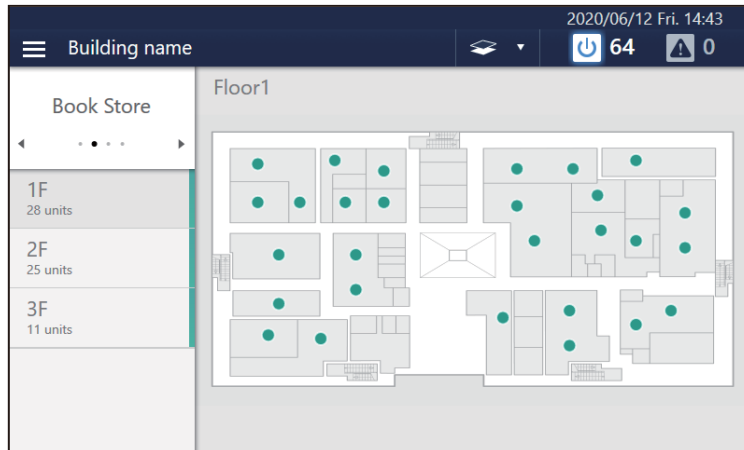

### How to display the screen



**1** From the home screen, tap . A pulldown menu appears.

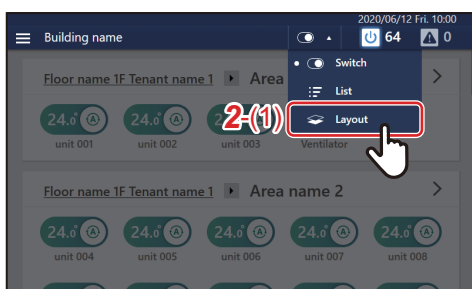

**2** Tap [2-(1)]. The layout screen appears.

### Screen description

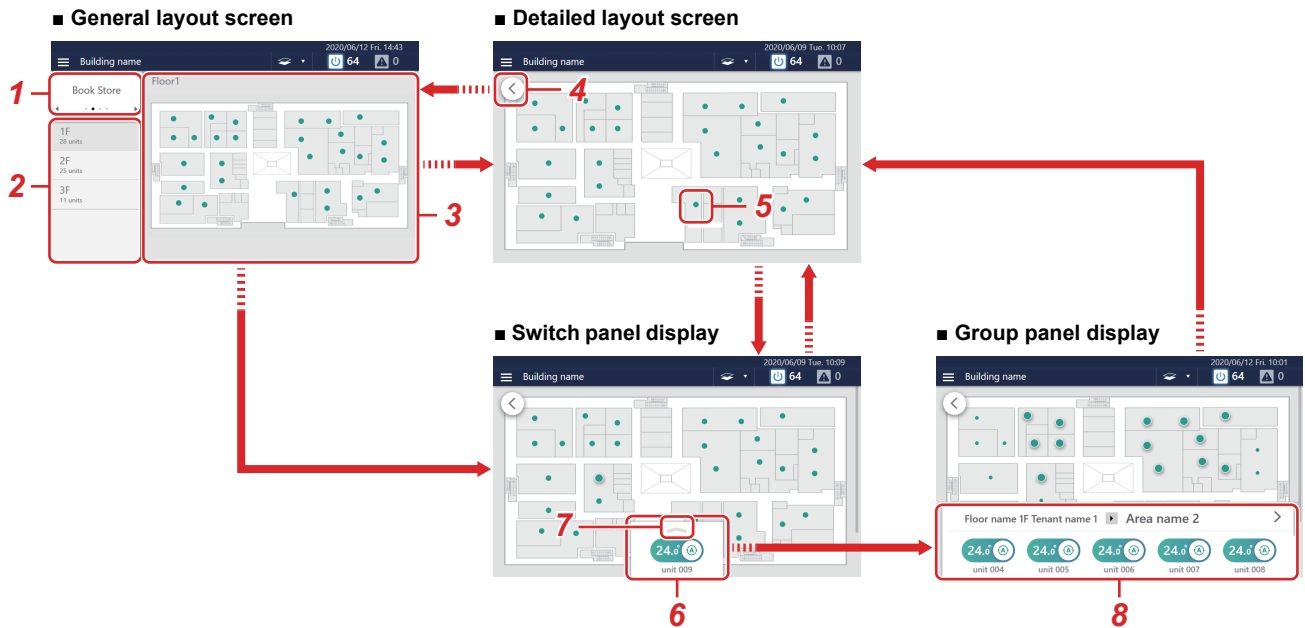

No.	Name (Icon)	Functions																
1	Layer Group Name	By swiping to the right or left in the Layer Group Name, you can change the selected layer.																
2	Level display area	You can select the floor to display in the floor layout. Displays the number of air conditioners installed on each layer. *																
3	Floor layout area	Tap to display the floor layout on the entire screen.																
4	BACK button	Returns you to the general layout screen.																
5	Unit icon	<p>Enables you to confirm the position of a unit on the floor layout.</p> <table border="1"> <thead> <tr> <th>Icon</th> <th>Description</th> </tr> </thead> <tbody> <tr> <td></td> <td>Indicates indoor unit and ON/OFF unit. Tap this icon to display the switch icon.</td> </tr> <tr> <td></td> <td>Indicates the Air to Water Heat Pump (ATW) of the hot water supply function. Tap this icon to display the switch icon.</td> </tr> <tr> <td></td> <td>Indicates the leak detector (LD). Tap this icon to display the status of the leak detector (LD).</td> </tr> <tr> <td></td> <td>Indicates the FS unit. Tap this icon to display the status of the FS unit.</td> </tr> <tr> <td></td> <td>Indicates the CO<sub>2</sub> sensor. Tap this icon to display the CO<sub>2</sub> information.</td> </tr> </tbody> </table> <p> ,  and  can be displayed as connected by wires to  . If you want to display the wires, refer to the manual for the Section Configuration Software.</p> <p>The following icon affixed with a figure is displayed if the display setting for the system cooperation defrosting settings is enabled.</p> <p>* For details, contact service personnel.</p> <table border="1"> <thead> <tr> <th>Icon</th> <th>Description</th> </tr> </thead> <tbody> <tr> <td></td> <td>The figure indicates the zone address of the system cooperation defrosting settings. If the figure is underlined, it means that the unit is in the process of preparing for heating. (including defrosting) The display color of the figure indicates the linkage address of the system cooperation defrosting settings, with black being the master unit, green being slave unit 2, and blue being slave unit 3.</td> </tr> </tbody> </table>	Icon	Description		Indicates indoor unit and ON/OFF unit. Tap this icon to display the switch icon.		Indicates the Air to Water Heat Pump (ATW) of the hot water supply function. Tap this icon to display the switch icon.		Indicates the leak detector (LD). Tap this icon to display the status of the leak detector (LD).		Indicates the FS unit. Tap this icon to display the status of the FS unit.		Indicates the CO <sub>2</sub> sensor. Tap this icon to display the CO <sub>2</sub> information.	Icon	Description		The figure indicates the zone address of the system cooperation defrosting settings. If the figure is underlined, it means that the unit is in the process of preparing for heating. (including defrosting) The display color of the figure indicates the linkage address of the system cooperation defrosting settings, with black being the master unit, green being slave unit 2, and blue being slave unit 3.
Icon	Description																	
	Indicates indoor unit and ON/OFF unit. Tap this icon to display the switch icon.																	
	Indicates the Air to Water Heat Pump (ATW) of the hot water supply function. Tap this icon to display the switch icon.																	
	Indicates the leak detector (LD). Tap this icon to display the status of the leak detector (LD).																	
	Indicates the FS unit. Tap this icon to display the status of the FS unit.																	
	Indicates the CO <sub>2</sub> sensor. Tap this icon to display the CO <sub>2</sub> information.																	
Icon	Description																	
	The figure indicates the zone address of the system cooperation defrosting settings. If the figure is underlined, it means that the unit is in the process of preparing for heating. (including defrosting) The display color of the figure indicates the linkage address of the system cooperation defrosting settings, with black being the master unit, green being slave unit 2, and blue being slave unit 3.																	
6	Selected unit	Displays the operating status of the tapped unit.																
7	Group display button	Tap to display the operating status of the group.																
8	Group display	Displays the operating status of units group by group.																

\* Only the Air to Water Heat Pump (ATW) hot water supplies, the number of FS units, LD and CO<sub>2</sub> sensors is not included.

**Group control screen ([CONTROL] tab)**

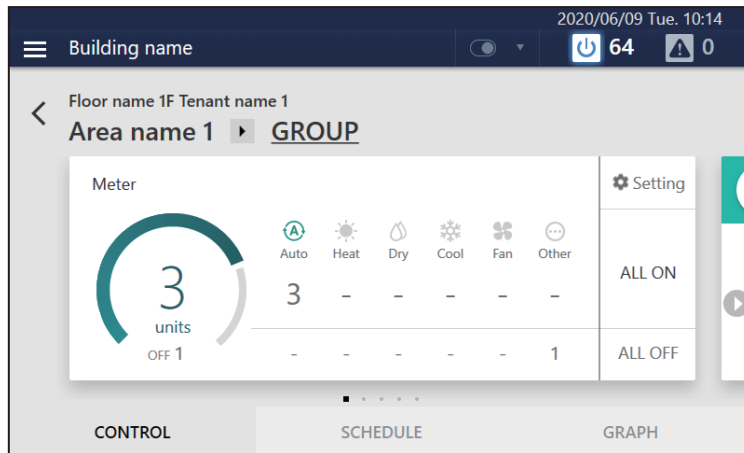

**How to display the screen**



- 1 **Scroll the home screen to display the group you want to change the settings for, then tap >**  
The [CONTROL] tab of the group screen is displayed.

**Screen description**

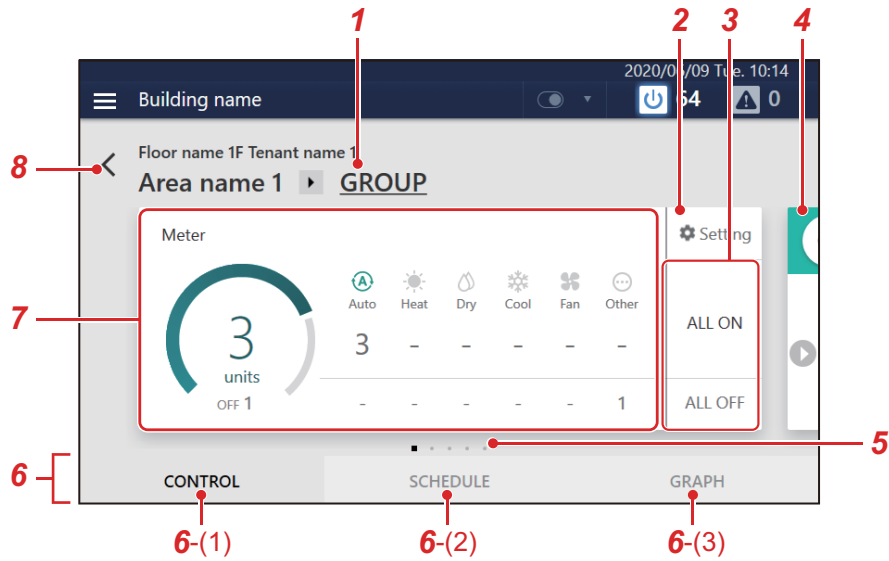

No.	Name (Icon)	Functions
1	Group name	Displays the name of the currently displayed group. Tap to display the drop-down menu. You can switch the display to the individual control screen for another air conditioner or ON/OFF unit registered in the group. <div style="border: 1px solid black; padding: 5px; width: fit-content; margin-left: 20px;">                         GROUP                          unit 001                          unit 002                          unit 003                          Ventilator                     </div>
2	Setting	You can change overall settings of the group such as Mode, set temperature, air direction, and fan speed simultaneously. (P.38)
3	ALL ON/ALL OFF	You can turn the whole group ON/OFF simultaneously. (P.36)
4	Next screen	Tap to display the individual control screen of the air conditioner or ON/OFF unit registered in the group. You can flick the group screen to display it.
5	Display position	Only the number of air conditioners or ON/OFF unit registered in the group <input type="checkbox"/> is displayed. For the currently displayed screen, <input checked="" type="checkbox"/> is displayed.
6	Switch tab	Tap to switch to the "6-(1)", "6-(2)" or "6-(3)" tab of the group screen.
7	Run	The ON/OFF meter on the left side can be used to check the total number of units operated in the group. On the right side you can check the number of units in each operation mode. The upper row shows the number of units in operation and the lower row shows the number of units stopped. If there are devices that do not have an operation mode, they will be displayed in [Other]. * The number of Air to Water Heat Pumps (ATW) of the hot water supply function is not included.
8	BACK button ( < )	Returns to the Home.

**Individual control screen ([CONTROL] tab)**

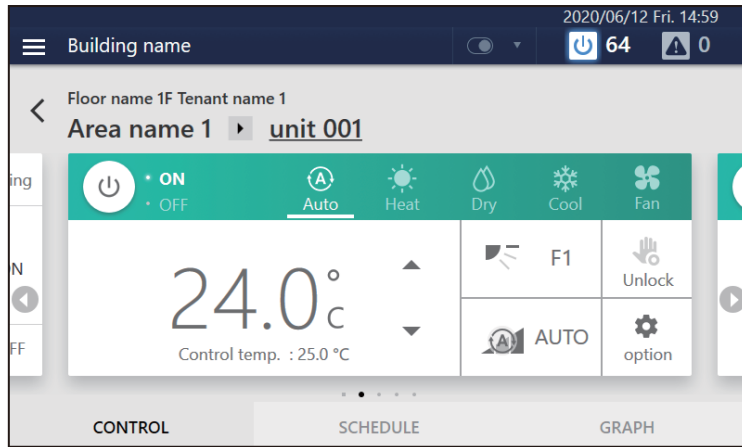

**How to display the screen**

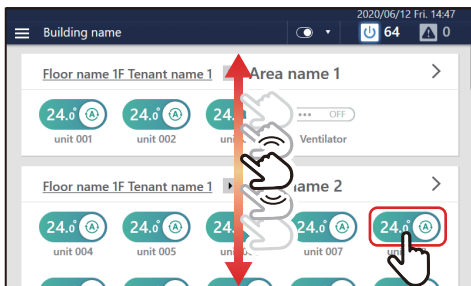

- 1 Scroll the home screen, display the air conditioner or ON/OFF unit that you want to change the settings for, then tap the switch**







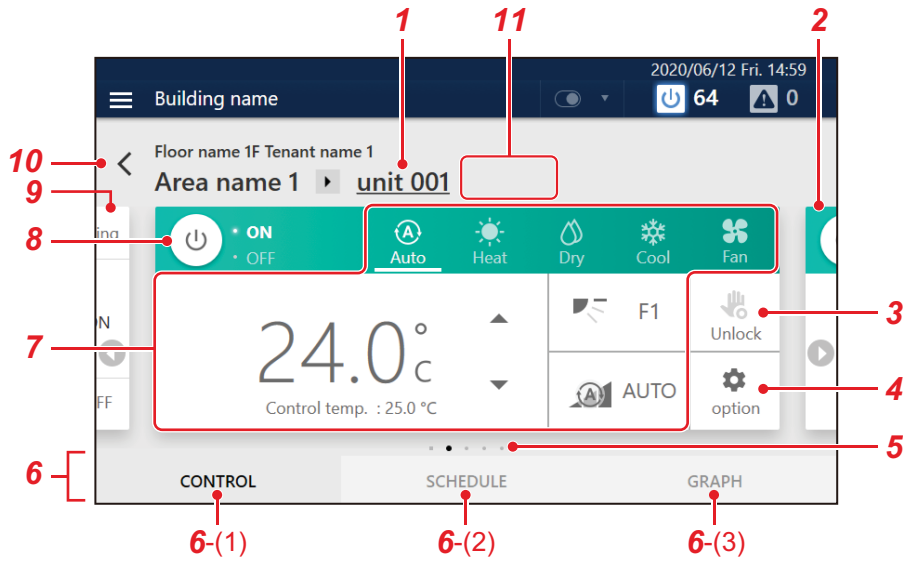

































The [CONTROL] tab of the individual control screen is displayed.



**Screen description**



No.	Name (Icon)	Functions					
1	Unit name	The name of the air conditioner or ON/OFF unit currently displayed is shown. Tap to display the drop-down menu. You can switch the display to the group screen or another air conditioner or ON/OFF unit registered in the group. <table border="1" style="float: right; margin-top: 10px;"> <tr><td>GROUP</td></tr> <tr><td>unit 001</td></tr> <tr><td>unit 002</td></tr> <tr><td>unit 003</td></tr> <tr><td>Ventilator</td></tr> </table>	GROUP	unit 001	unit 002	unit 003	Ventilator
GROUP							
unit 001							
unit 002							
unit 003							
Ventilator							
2	Next screen	Tap to display the individual control screen for other air conditioners or ON/OFF unit registered in the group. You can also flick and display the individual control screen being displayed.					
3	Lock setting of remote control	You can restrict the operating range of the local remote controller of the air conditioner(s) or ON/OFF unit. (P.51) If it is not restricted, [🔓] is displayed. If there are restricted items, [🔒] is displayed.					
4	option	You can set or confirm the details of the operation method. (P.53)					
5	Display position	Only the number of devices registered in the group [ ] is displayed. For the currently displayed screen, [ ] is displayed.					
6	SWITCH tab	Tap to switch to the "6-(1)", "6-(2)" or "6-(3)" tab of the individual control screen.					
7	Setting area	You can change basic settings such as operation mode, set temperature, air direction, and fan speed. (P.41)					
8	ON/OFF	Tap to switch between ON/OFF.					
9	Previous screen	Tap to display the individual control screen for other air conditioners or ON/OFF unit registered in the group. You can also flick and display the individual control screen being displayed. The group screen appears at the beginning.					
10	BACK button ( < )	Returns to the home screen.					

No.	Name (Icon)	Functions																	
<b>11</b>	Remote-less 	Displays an icon for indoor units that have no local remote control.																	
	(LD) Refrigerant sensor life pre-notification 	This icon is displayed when the end of the operating life of the sensor in the connected leak detector (LD) is approaching. If this icon is displayed, contact your retailer or a service person.																	
	(FS unit) Out of battery 	This icon is displayed when the battery in the FS unit dies. If this icon is displayed, contact your retailer or a service person.																	
	(FS unit) Blocking 	This icon is displayed when the refrigerant in the FS unit is blocked.																	
	Stirring operation 	This icon is displayed when the stirring operation is in progress.																	
	Night operation (VRF, LC, ESTIA) 	This icon is displayed when the night operation setting is enabled.																	
	Ventilation operation 	This icon is displayed when the ventilation fan is in operation.																	
	Ventilation mode	An icon of the ventilation mode in operation is displayed. <table border="1" data-bbox="638 694 1013 851"> <thead> <tr> <th>Icon</th> <th>Ventilation mode</th> </tr> </thead> <tbody> <tr> <td></td> <td>Bypass</td> </tr> <tr> <td></td> <td>Automatic</td> </tr> <tr> <td></td> <td>Heat exchange</td> </tr> </tbody> </table>	Icon	Ventilation mode		Bypass		Automatic		Heat exchange									
	Icon	Ventilation mode																	
		Bypass																	
	Automatic																		
	Heat exchange																		
Ventilation fan speed	An icon of the operating ventilation fan speed is displayed. <table border="1" data-bbox="638 918 1220 1265"> <thead> <tr> <th>Icon</th> <th>Ventilation fan speed</th> </tr> </thead> <tbody> <tr> <td></td> <td>High</td> </tr> <tr> <td></td> <td>Medium</td> </tr> <tr> <td></td> <td>Low</td> </tr> <tr> <td></td> <td>Auto</td> </tr> <tr> <td></td> <td>Unbalance High (exhaust air prioritized)</td> </tr> <tr> <td></td> <td>Unbalance High (supply air prioritized)</td> </tr> <tr> <td></td> <td>Unbalance Medium (exhaust air prioritized)</td> </tr> <tr> <td></td> <td>Unbalance Medium (supply air prioritized)</td> </tr> </tbody> </table>	Icon	Ventilation fan speed		High		Medium		Low		Auto		Unbalance High (exhaust air prioritized)		Unbalance High (supply air prioritized)		Unbalance Medium (exhaust air prioritized)		Unbalance Medium (supply air prioritized)
Icon	Ventilation fan speed																		
	High																		
	Medium																		
	Low																		
	Auto																		
	Unbalance High (exhaust air prioritized)																		
	Unbalance High (supply air prioritized)																		
	Unbalance Medium (exhaust air prioritized)																		
	Unbalance Medium (supply air prioritized)																		
Humidification setting 	This icon is displayed when the humidification setting is set to Auto.																		

## For the Air to Water Heat Pump (ATW)

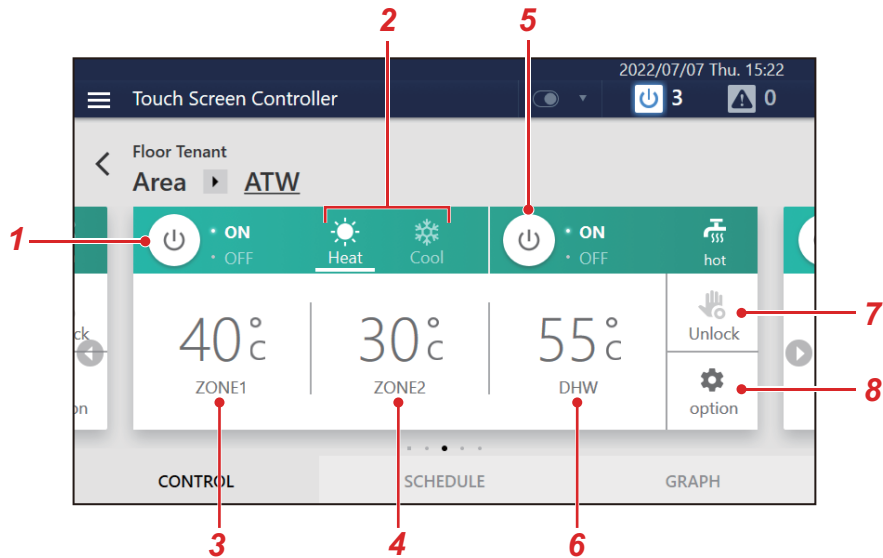

No.	Name (Icon)	Functions
1	Air conditioning ON/OFF icon	Tap to turn the air conditioning on or off.
2	Operation mode	You can change the air conditioner's operation mode. You can only change between heating and cooling.
3	ZONE1 Set temp.	You can change the set temperature of ZONE1.
4	ZONE2 Set temp.	You can change the set temperature of ZONE2.
5	DHW ON/OFF icon	Tap to turn the hot water on or off.
6	Hot water setting temperature	You can change the set temperature of hot water.
7	Lock setting of remote control	You can restrict the operating range of the local remote controller of the air conditioner(s) or ON/OFF unit. (P.51) If it is not restricted, [🔒] is displayed. If there are restricted items, [🔓] is displayed.
8	option	You can set or confirm the details of the operation method. (P.53)

### • NOTE

This screen is an example display for the Air to Water Heat Pump (ATW). Depending on the connected model, it may not be configurable.

**NOTE**

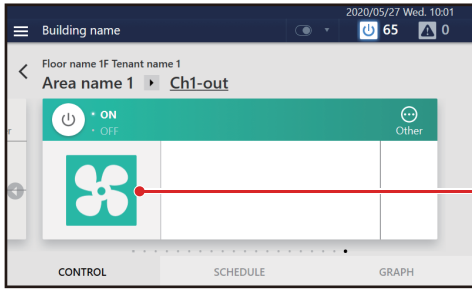

- For ON/OFF unit, only configurable items are displayed.

Icons are displayed only when they are registered. (P.87)

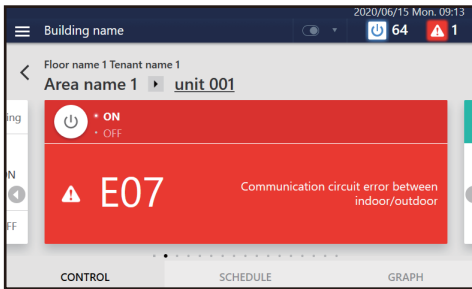

- If a malfunction occurs, a check code is displayed. Operation other than operation ON/OFF is not possible.

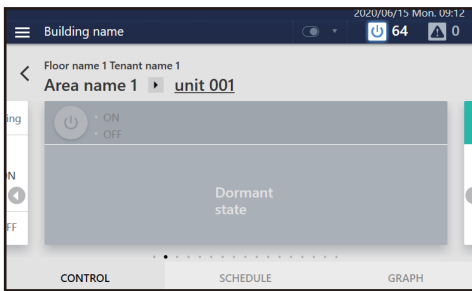

- Operation is impossible due to power outage (hibernation state).

# 5 Perform Initial Settings

## CAUTION

You cannot connect the Unit to the Internet. Never connect it.  
To connect to an external device, use a local area connection.

## Unit Settings

Have service personnel perform the following work.

- 1 Check the installation and wiring of the main unit**  
Follow the installation instructions to complete the installation and wiring work.
- 2 Check the wiring between the remote controller, indoor unit, and outdoor unit**  
Check that the address from the remote controller to the Unit is correct, and switch ON/OFF, Cool/Heat and confirm that operation is normal.
- 3 Create a local setting file with the Setting File Creation Software 2**  
Input necessary information based on local air conditioner information and display language settings, etc. into a PC on which the Setting File Creation Software 2 is installed to create a local settings file.
- 4 Upload the local settings file**  
Connect the Unit to the PC via LAN and upload the local settings file.  
While uploading, the Unit restarts.
- 5 Confirm the setting contents**  
Check that the screen display of the Unit is set according to the local settings file, perform ON/OFF, and confirm that the Unit operated on the screen matches the Unit that actually starts to operate.

## NOTE

If, after the initial settings, you want to change the names of tenants, groups, or air conditioners from the customer's computer, use "Section Configuration Software" the PC software provided.

You can download the owner's manual and installer for "Section Configuration Software" from inside the controller.

After setting the IP address of the computer (P.31), use the customer's web browser to access the following URL.

<http://192.168.2.80/touchscreencontroller/EN/download.html> \*

\* Input the value set in "Set the IP address of the Touch screen controller" (P.91) in place of "192.168.2.80".

## Settings for Remote Monitoring with a PC

You can monitor and control the Unit by accessing it from a PC. This section explains the settings for the Unit and the PC. Please see "9. Remote Monitoring Using a PC" (P.101) for the system diagram and the PC operating environment.

**NOTE**

Some functions cannot be used from a PC. For details, please see "List by Lock Level/Level" (P.115)

### System diagram

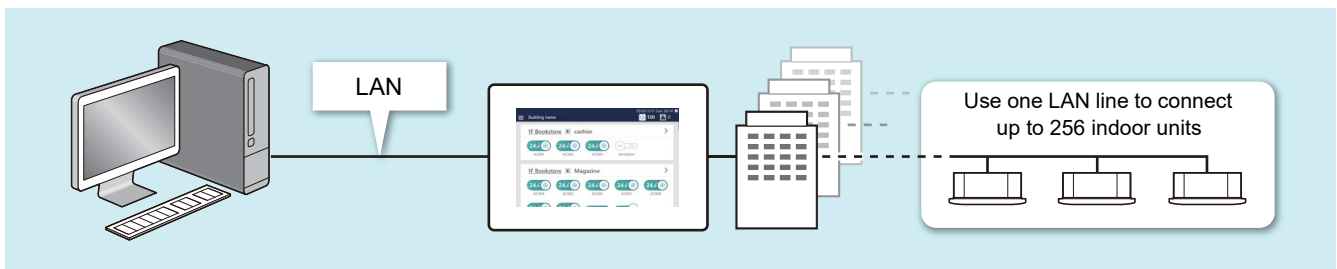

### Unit settings

- 1** Set the user account for remote operation (P.88)
- 2** Set the IP address (P.91)
- 3** Set a destination to send email to when a malfunction occurs (P.92)

### PC settings

#### Settings

IP address/ Subnet mask	Set it to be the same network as the Unit. (Example: the Unit 192.168.2.80/PC 192.168.2.90/subnet 255.255.255.0)
Drive C	Ensure that you have 500 MB or more free space and start up as a user with read/write authority.

### Operating environment

The following environment is necessary to use this function.

OS	Windows 10, Windows 11
.NET Framework	4.8
Web browser	Microsoft Edge, Google Chrome latest version

**How to set the IP address of the PC**

- 1** Display the properties of the network to connect to the System Controller
- 2** Check "Internet Protocol Version 4 (TCP / IPv4)" and click the [Properties] button
- 3** Select "Use the following IP address", set IP address to **192.168.2.\*\*\*** and Subnet mask to **255.255.255.0**, and click the OK button \*

\* For "\*\*\*", enter an address different from that of the System Controller to connect.

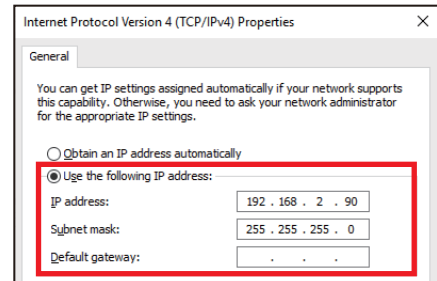
**NOTE**

If your PC is set to use a proxy server, exclude the IP address of the System Controller.

## Install the software

- 1 Open the web browser of your PC
- 2 Access "[http://\[server name or IP address\]/touchscreencontroller/\[language code\]/download.html](http://[server name or IP address]/touchscreencontroller/[language code]/download.html)"

Server name or IP address : Input the IP address that was set in "Set the IP address of the Touch screen controller" (P.91).

Language code: Enter the following value according to the language.

Language	Language Code
Japanese	JA
English	EN
French	FR
German	DE
Italian	IT
Spanish	ES
Portuguese	PT
Dutch	NL
Greek	EL

Language	Language Code
Russian	RU
Turkish	TR
Swedish	SV
Finnish	FI
Danish	DA
Norwegian	NO
Polish	PL
Bulgarian	BG
Romanian	RO

Language	Language Code
Estonian	ET
Latvian	LV
Croatian	HR
Slovak	SK
Slovene	SL
Hungarian	HU
Czech	CS
Chinese	ZH
Korean	KO

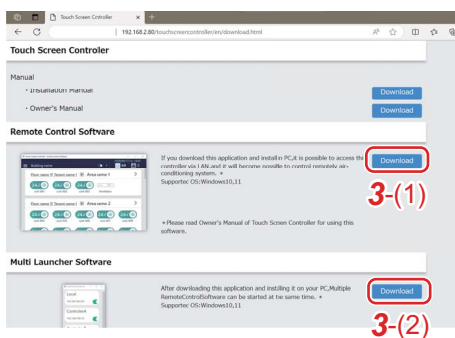

- 3 Click [3-(1)] \*
- 4 Save the file according to the browser message
- 5 Double-click on the saved "installer\_touchscreencontroller.exe" to unzip/install (setup.exe)

When the installation is completed, a shortcut icon is created on the desktop.

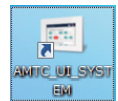

For remote monitoring of multiple system controllers with a PC, click [3-(2)] to similarly install the software.

A shortcut icon is created on the desktop when installation is complete.

### NOTE

If .NET Framework 4.8 is not installed on the PC, this software will not work properly. Be sure to download and install .NET Framework 4.8 from the above website.

\* About downloading the application

Depending on the browser and other settings, application download may be blocked or not executed due to security and other functions.

Please download selecting "Save" or "Download" from the download option menu.



## Setting when Using Energy Report Software 2

By using the Energy Report Software 2, you can display the operation status and operation history of the air conditioners aggregated by this Unit on a PC screen. You can also easily check and output reports (monthly report/daily report) for electric power distribution with a PC. When using the Energy Report Software 2, apply the following settings.

### • NOTE

For details on how to use the Energy Report Software 2, refer to the Operating Instructions of the Energy Report Software 2.

### Unit settings

- 1 Set the IP address of the Unit (P.91)**

### PC settings

- 1 Install the Energy Report Software 2 on the PC**
- 2 Register the target system (this Unit) in the Energy Report Software 2**

# 6 Basic Usage

This section explains the basic setting method for operation Start/Stop and air conditioning, the setting method for the operation schedule, and the confirmation method for the overall air conditioning system.

## Start/Stop Operation

### Overall air conditioning system operation method

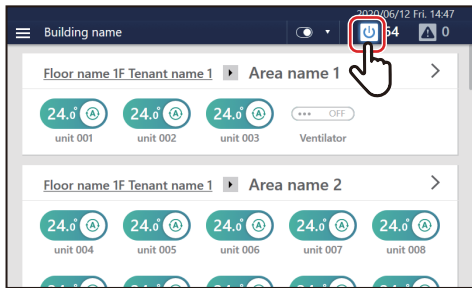

1 Tap  

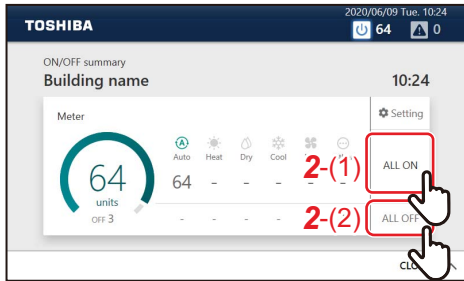

2 Tap [2-(1)] or [2-(2)]

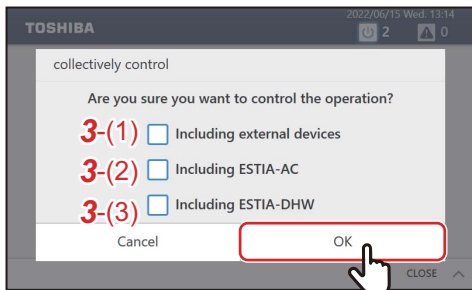

3 Select the equipment to add to be operated, and then tap [3-(4)]

All the air conditioners and the selected equipment start or stop operations.

The selected equipment and air conditioners are added to equipment to be operated. \*

No.	Item	Equipment to be added
3-(1)	Including external devices	External device
3-(2)	Including ESTIA-AC	Air to Water Heat Pump (ATW) with air conditioning function
3-(3)	Including ESTIA-DHW	Air to Water Heat Pump (ATW) in hot water supply function

\* About selecting confirmation popups

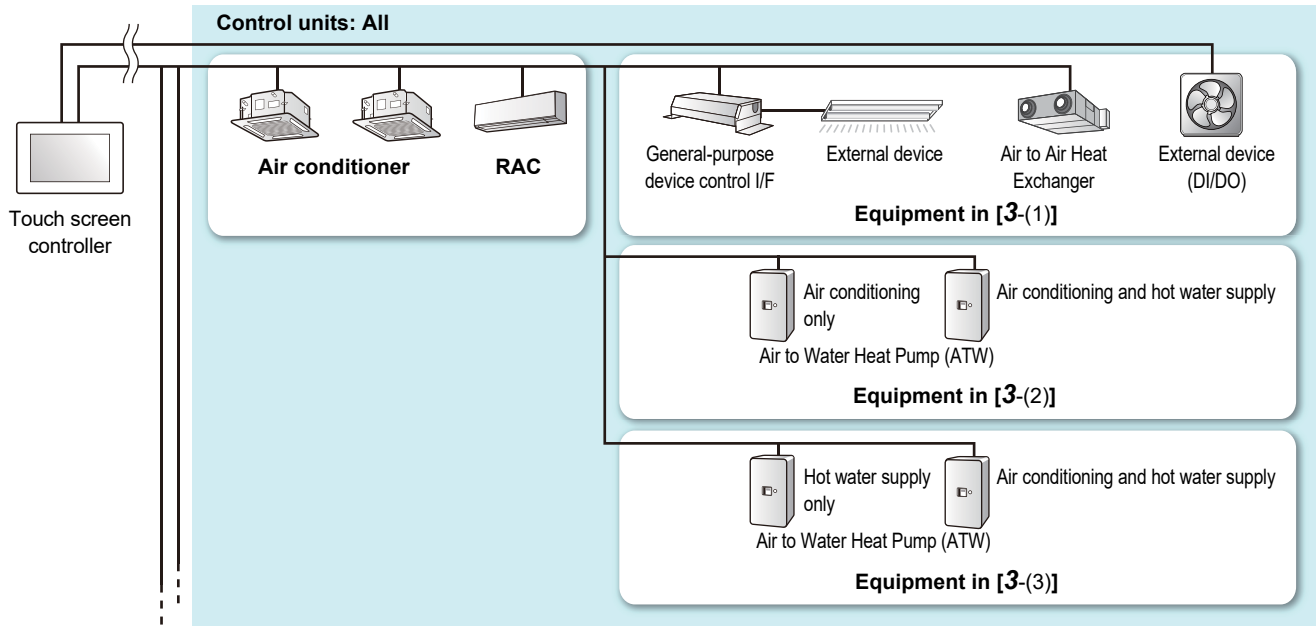

**Group unit operation method**



**1** Scroll the home screen to display the group you want to change the settings for, then tap >

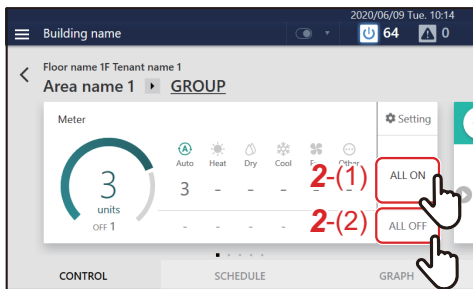

**2** Tap [2-(1)] or [2-(2)]

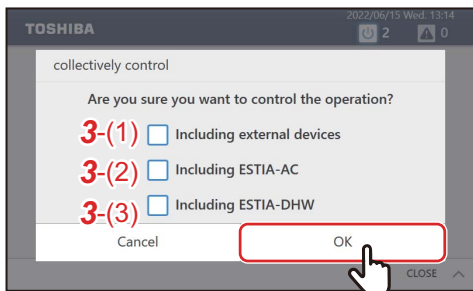

**3** Select the equipment to add to be operated, and then tap [3-(4)]

All the air conditioners selected in the group and the selected equipment start or stop operations.

The selected equipment and air conditioners are added to equipment to be operated. \*

No.	Item	Equipment to be added
3-(1)	Including external devices	External device
3-(2)	Including ESTIA-AC	Air to Water Heat Pump (ATW) with air conditioning function
3-(3)	Including ESTIA-DHW	Air to Water Heat Pump (ATW) in hot water supply function

\* About selecting confirmation popups

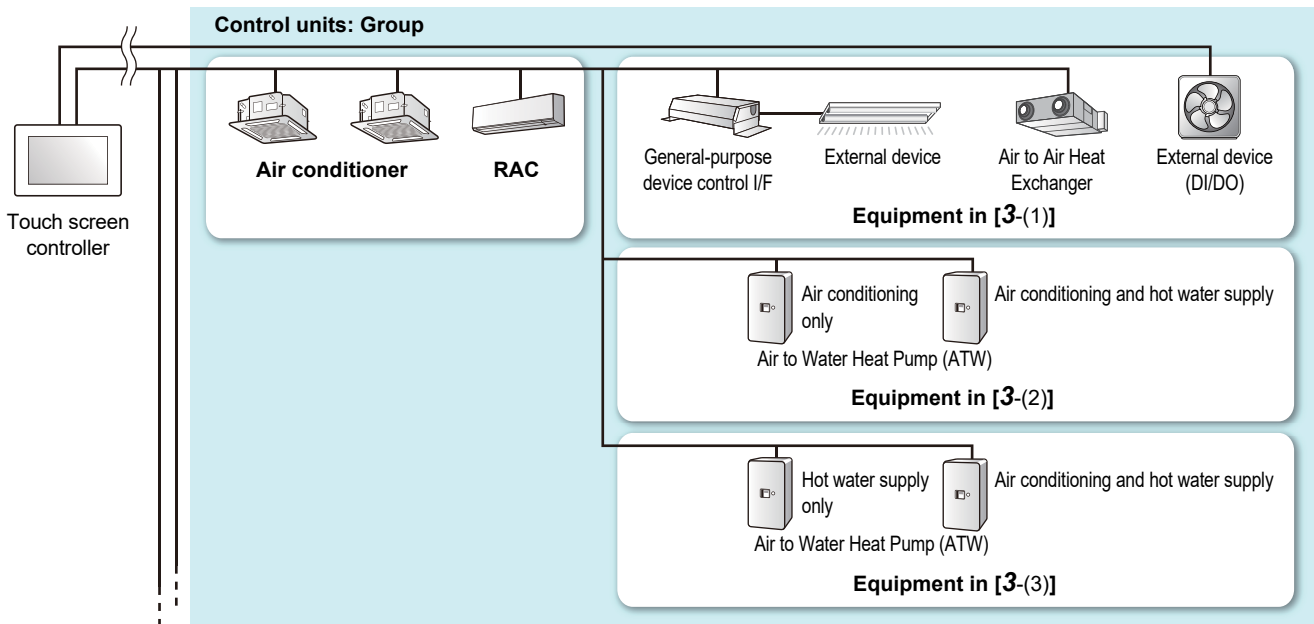

**Operation method in units of air conditioner or ON/OFF unit**

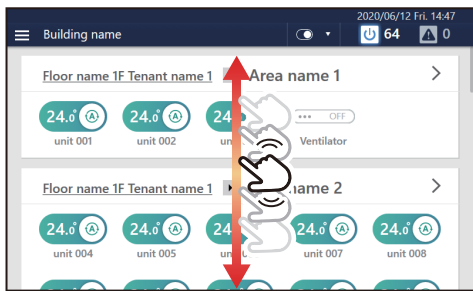

**1** Scroll the home screen and display the air conditioner or ON/OFF unit that you want to change the settings for

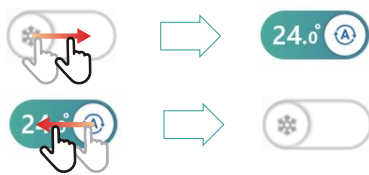

**2** Drag or flick the  of the corresponding switch  
 Drag or flick to the right to start operation.  
 Drag or flick to the left to stop operation.

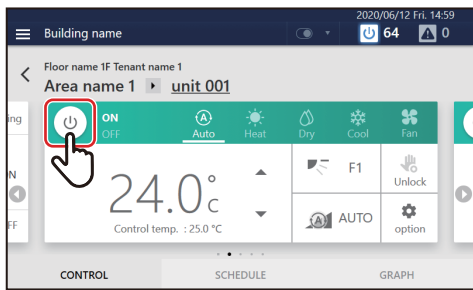

**NOTE**

You can also start/stop operation by tapping the power icon on the [CONTROL] tab on the individual control screen displayed by tapping the switch.

# Change the Air Conditioning Settings

## Group unit operation method

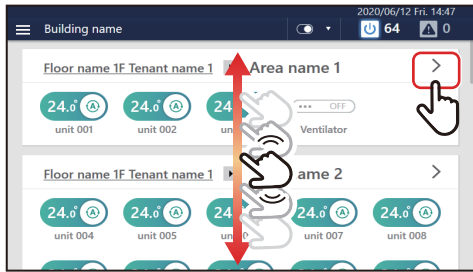

**1** Scroll the home screen to display the group you want to change the settings for, then tap >

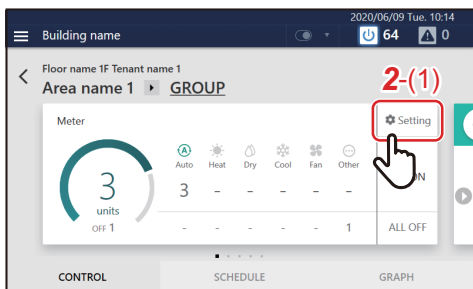

**2** Tap [2-(1)]  
The batch settings screen is displayed.



**3** Change settings

**Example: When changing the operation status settings**

**3-1** Tap [3-(1)]  
The operation status settings screen is displayed.

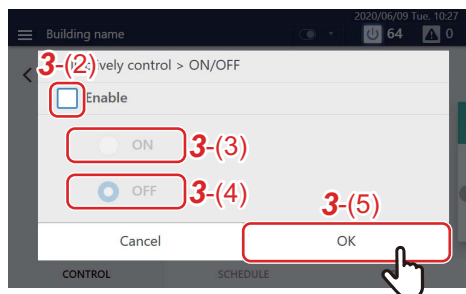



**3-2** Set the check box of [3-(2)] to   
You can now change the settings.

**3-3** Select [3-(3)] or [3-(4)] and tap [3-(5)]  
Return to the batch settings screen.

**3-4** Change the other items with reference to steps 3-1 to 3-3  
For the setting details, see the following table.

No.	Name	Functions
1	ON/OFF	Can be set to [ON/OFF].
2	Mode	Can be set to [Auto/Heat/Dry/Cool/Fan]. <div style="background-color: #cccccc; padding: 2px;"> <b>NOTE</b> </div> <ul style="list-style-type: none"> <li>A bar is displayed at the bottom of the icon for the currently selected mode.</li> <li>Operation modes that cannot be set are not displayed.</li> </ul>

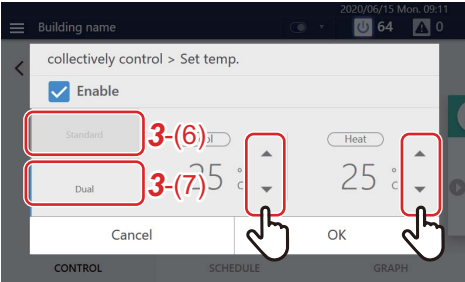
No.	Name	Functions
3	Wind direction (up / down)	<p>Tap ◀ ▶ to switch to the following.</p>  <p>• <b>NOTE</b></p> <p>Depending on the connected model, it may not be configurable.</p>
4	Fan Speed	<p>Tap ◀ ▶ to switch to the following.</p>  <p>• <b>NOTE</b></p> <p>Depending on the connected model, it may not be configurable.</p>
5	Set temp.	<p>Tap ▲ ▼ to change the set temperature.</p> <p>• <b>NOTE</b></p> <ul style="list-style-type: none"> <li>When set to a temperature outside the setting range limit of each operation mode, the temperature is changed to the upper or lower limit of the setting range.</li> <li>If there are Dual Set Point compatible models in the group, two tabs will be displayed. When you tap [3-(6)], one set temperature is displayed, and when you tap [3-(7)], two set temperatures are displayed. Tap ▲ ▼ to change the set temperature.</li> </ul> 

• **NOTE**

- For models that do not have the function set, the setting change is ignored.
- For the setting of [Lock] [Unlock] of [3-(8)], see "Local Remote Controller Lock" (P.51).
- For the [Option] settings of [3-(9)], see "Set Operation Details" (P.53).

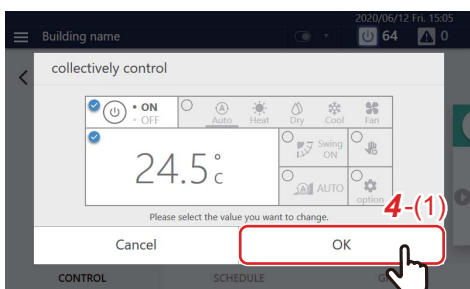

**4** Confirm that the changed item is checked, and tap [4-(1)]

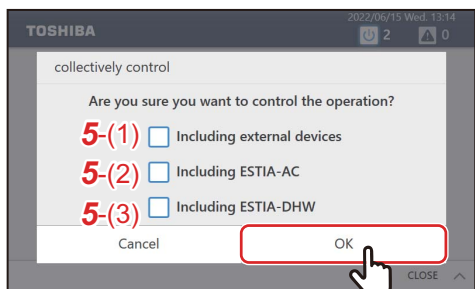

**5** Select the equipment to add to be operated, and then tap [5-4]

All the air conditioners selected in the group and the selected equipment start or stop operations.

The selected equipment and air conditioners are added to equipment to be operated. \*

No.	Item	Equipment to be added
5-(1)	Including external devices	External device
5-(2)	Including ESTIA-AC	Air to Water Heat Pump (ATW) with air conditioning function
5-(3)	Including ESTIA-DHW	Air to Water Heat Pump (ATW) in hot water supply function

\* About selecting confirmation popups

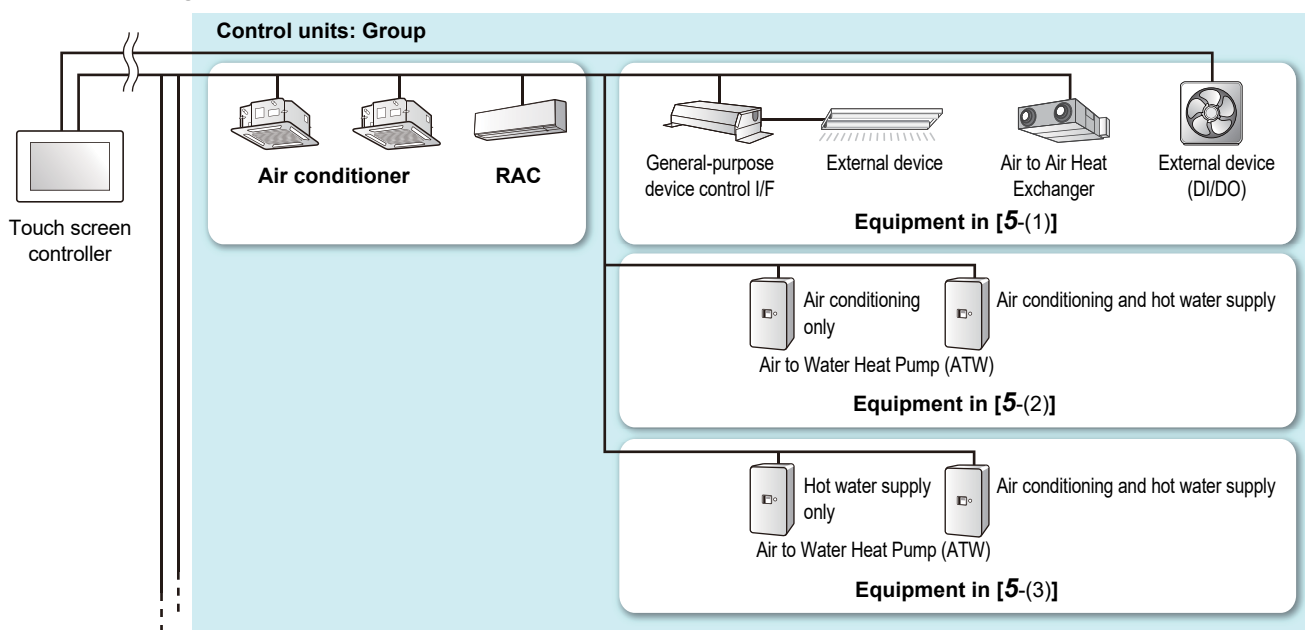



**Air conditioner unit operation method**

**NOTE**

To change the settings, it is necessary to set to the operation status. (P.37)

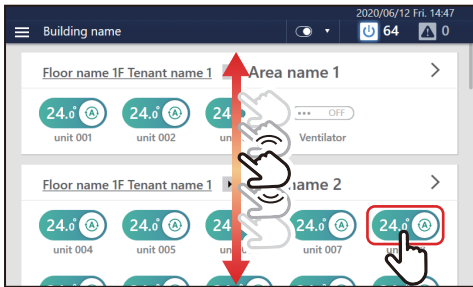

**1** Scroll the home screen, display the air conditioner you want to change the settings for, then tap the switch

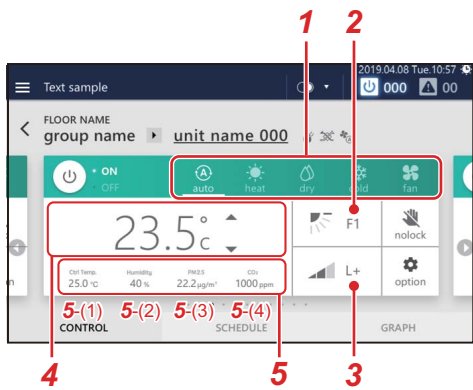

**2** Change settings

No.	Name	Functions						
1	Mode	<p>Can be set to [Auto/Heat/Dry/Cool/Fan].</p> <p><b>NOTE</b></p> <ul style="list-style-type: none"> <li>A bar is displayed at the bottom of the icon for the currently selected mode.</li> <li>Operation modes that cannot be set are not displayed.</li> </ul>						
2	Wind direction (up / down)	<p>Tap to switch to the following.</p> <table border="1"> <thead> <tr> <th>Operation Mode</th> <th>Setting Range</th> </tr> </thead> <tbody> <tr> <td>Auto (Cool)/Cool/Dry</td> <td>Swing ON→Swing OFF→F1→F2→F3→Swing ON (Return to the beginning)</td> </tr> <tr> <td>Auto (Heat)/Heat/Fan</td> <td>Swing ON→Swing OFF→F1→F2→F3→F4→F5→Swing ON (Return to the beginning)</td> </tr> </tbody> </table> <p><b>NOTE</b></p> <p>Depending on the connected model, it may not be configurable.</p>	Operation Mode	Setting Range	Auto (Cool)/Cool/Dry	Swing ON→Swing OFF→F1→F2→F3→Swing ON (Return to the beginning)	Auto (Heat)/Heat/Fan	Swing ON→Swing OFF→F1→F2→F3→F4→F5→Swing ON (Return to the beginning)
Operation Mode	Setting Range							
Auto (Cool)/Cool/Dry	Swing ON→Swing OFF→F1→F2→F3→Swing ON (Return to the beginning)							
Auto (Heat)/Heat/Fan	Swing ON→Swing OFF→F1→F2→F3→F4→F5→Swing ON (Return to the beginning)							

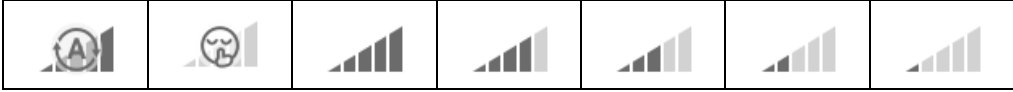
No.	Name	Functions															
<b>3</b>	Fan Speed	<p>Tap to switch to the following.</p>  <p>• <b>NOTE</b></p> <p>Depending on the connected model, it may not be configurable.</p>															
<b>4</b>	Set temp.	<p>Tap ▲ ▼ to change the set temperature.</p> <p>• <b>NOTE</b></p> <ul style="list-style-type: none"> <li>• If the operation mode is FAN, the temperature cannot be set.</li> <li>• In this area, icons and text are displayed, such as for frost protection, preparing for operation, or preparing for heating operation.</li> </ul>															
<b>5</b>	Sensor value display	<table border="1"> <thead> <tr> <th>No.</th> <th>Name</th> <th>Functions</th> </tr> </thead> <tbody> <tr> <td><b>5-(1)</b></td> <td>Ctrl temp.</td> <td> <p>Indicates the partially compensated temperature inside the room that is detected by the indoor unit.</p> <p>• <b>NOTE</b></p> <p>The room temperature may differ from the actual temperature depending on the installation location of the indoor unit and other conditions.</p> </td> </tr> <tr> <td><b>5-(2)</b></td> <td>Humidity</td> <td>Indicates the humidity detected by the indoor unit.</td> </tr> <tr> <td><b>5-(3)</b></td> <td>CO<sub>2</sub></td> <td>Indicates the CO<sub>2</sub> detected by the indoor unit.</td> </tr> <tr> <td><b>5-(4)</b></td> <td>PM2.5</td> <td>Indicates PM2.5 detected by the indoor unit.</td> </tr> </tbody> </table> <p>• <b>NOTE</b></p> <p>Depending on the connected model, it may not be indicated.</p>	No.	Name	Functions	<b>5-(1)</b>	Ctrl temp.	<p>Indicates the partially compensated temperature inside the room that is detected by the indoor unit.</p> <p>• <b>NOTE</b></p> <p>The room temperature may differ from the actual temperature depending on the installation location of the indoor unit and other conditions.</p>	<b>5-(2)</b>	Humidity	Indicates the humidity detected by the indoor unit.	<b>5-(3)</b>	CO <sub>2</sub>	Indicates the CO <sub>2</sub> detected by the indoor unit.	<b>5-(4)</b>	PM2.5	Indicates PM2.5 detected by the indoor unit.
No.	Name	Functions															
<b>5-(1)</b>	Ctrl temp.	<p>Indicates the partially compensated temperature inside the room that is detected by the indoor unit.</p> <p>• <b>NOTE</b></p> <p>The room temperature may differ from the actual temperature depending on the installation location of the indoor unit and other conditions.</p>															
<b>5-(2)</b>	Humidity	Indicates the humidity detected by the indoor unit.															
<b>5-(3)</b>	CO <sub>2</sub>	Indicates the CO <sub>2</sub> detected by the indoor unit.															
<b>5-(4)</b>	PM2.5	Indicates PM2.5 detected by the indoor unit.															

**NOTE**

- For the setting of [(1)], see "Local Remote Controller Lock" (P.51).
- For the setting of [(2)], see "Set Operation Details" (P.53).
- If there is no corresponding function, that item is not displayed.

**Example of a model without a wind direction (up / down)**

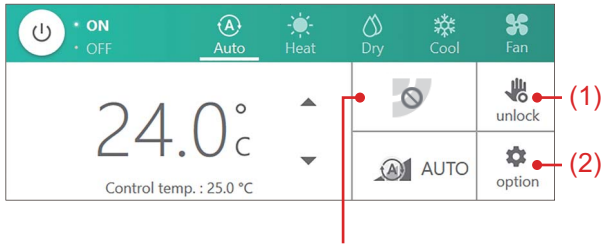

Since you cannot set the air direction, it does not change even if you tap it.

**Example of a model where only a certain fan speed can be set**

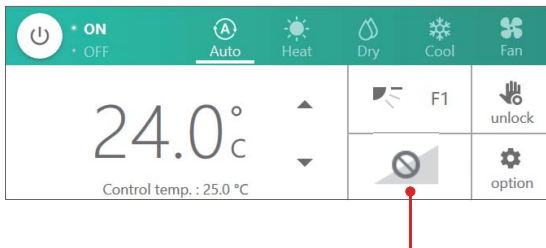

Since you cannot change the fan speed, it does not change even if you tap it.

**Example of a case in which the wind direction (up / down) cannot be changed**

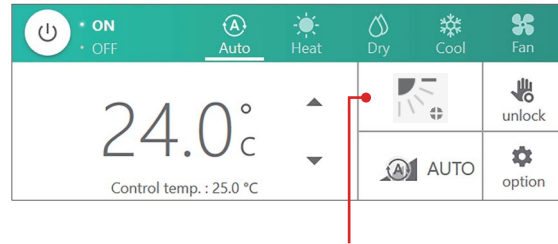

Because the wind direction (up / down) is locked, you cannot change the wind direction (up / down) even if you tap it.

## Set the Operation Schedule

You can configure the air conditioners or the ON/OFF unit with a “Weekly schedule”, through which settings such as operation start/stop are changed depending on the specified time for any day from Sunday to Saturday, or a “Special day schedule”, through which settings are changed for special days such as national holidays or special holidays. The operation schedule is set on the [SCHEDULE] tab of the group screen or individual control screen.

**NOTE**

If a day is set in both the Weekly schedule and the Special day schedule, the Special day schedule applies and the Weekly schedule is disabled for that day.

### Screen description

This section explains how to view the [SCHEDULE] tab when setting the operation schedule.

**NOTE**

Refer to the description of the [CONTROL] tab for the display items that are not explained. (P.22, 24)

### Group screen

The schedule set for the air conditioners or ON/OFF unit in the group is displayed in list format in time units.

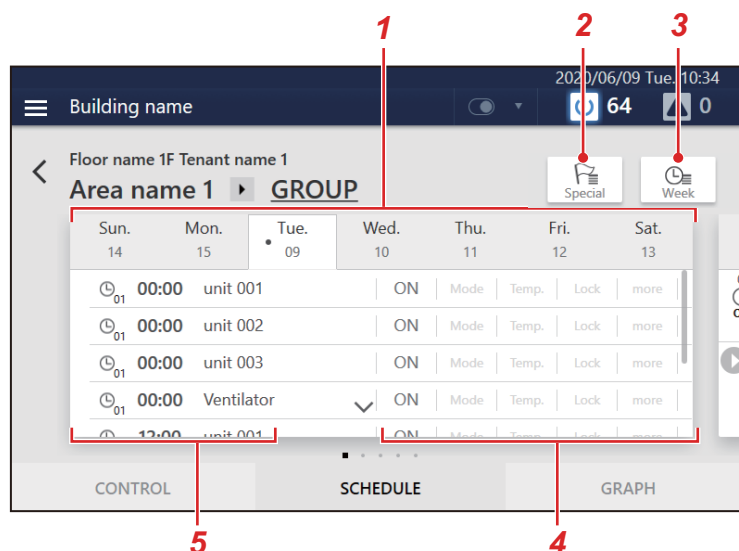

No.	Functions
1	You can switch the display in day-of-week units.
2	Displays the setting screen of Special day schedule.
3	Displays the setting screen of Weekly schedule.
4	The schedule settings content (ON/OFF, Mode, Temp., Lock, more) is displayed.
5	The times when the schedule is executed and the air conditioners and ON/OFF unit for which the schedule is executed are displayed.

### Individual control screen

The schedule set for the air conditioner or ON/OFF unit being displayed is displayed on a 24-hour time scale.

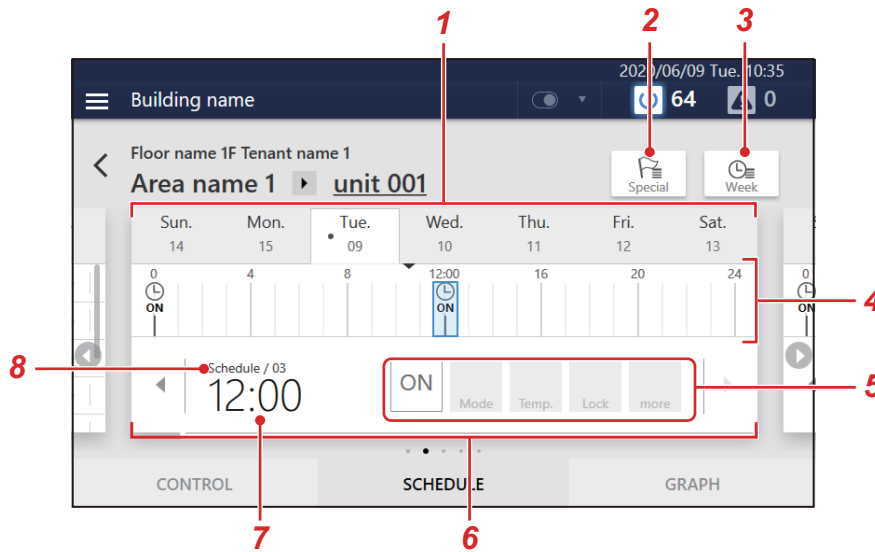

No.	Functions
1	You can switch the display in day-of-week units.
2	Displays the setting screen of Special day schedule.
3	Displays the setting screen of Weekly schedule.
4	🕒 is displayed at the times when the schedule is set. When operation start/stop is set, [ON] or [OFF] is displayed below 🕒. When setting change is set, ⚙️ is displayed below 🕒. Also, the currently displayed schedule is displayed in blue.
5	The schedule settings content (ON/OFF, Mode, Temp., Lock, more) is displayed.
6	You can switch the display to the previous or next schedule.
7	The times when the schedule will be executed are displayed.
8	The schedule setting number is displayed.

## Create a new weekly schedule

In a Weekly schedule, you can set:

- Start time
- Day(s) of the week
- Air conditioner(s) or ON/OFF unit
- ON/OFF

Schedule settings can be applied from either the group screen or the individual control screen. In the following procedure, the individual control screen is used to explain.

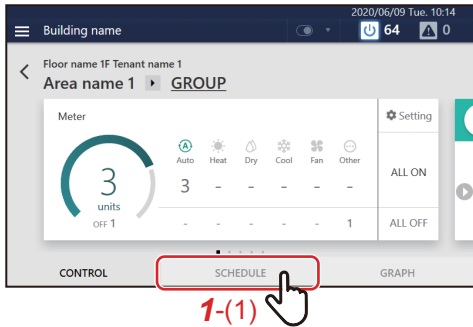

**1** Tap [1-(1)] on the group screen or individual control screen

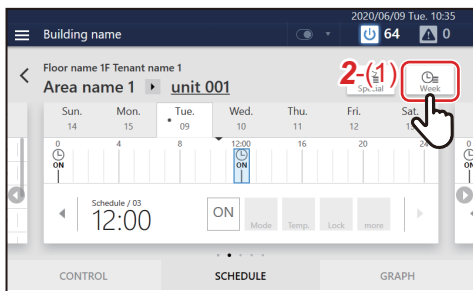

**2** Tap [2-(1)]

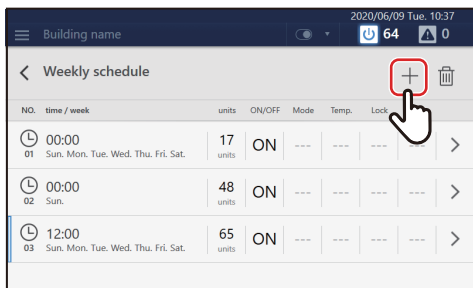

**3** Tap +

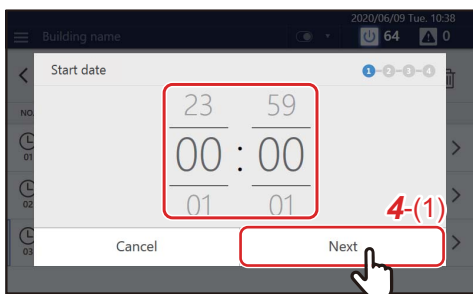

**4** Tap or flick to set the start time and tap [4-(1)]

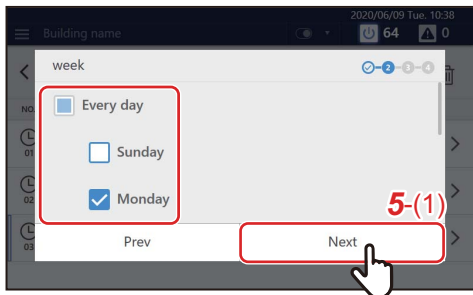

**5** Select the day of the week to execute and tap [5-(1)]

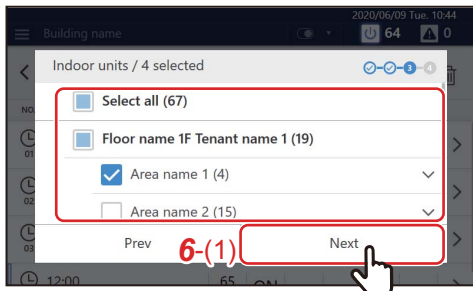

**6** Select the air conditioner(s) or ON/OFF unit for setting the schedule and tap [6-(1)]

You cannot select a model that has already been scheduled at the same time.



**7** Tap the check box of [7-(1)] and set it to , then select [7-(2)] or [7-(3)] and tap [7-(4)]

You can only set [ON/OFF] here.

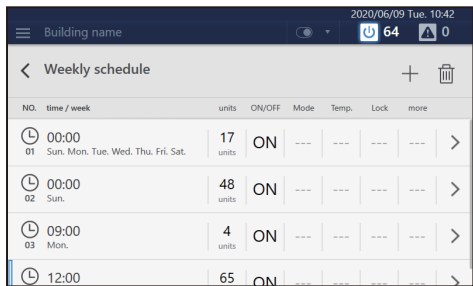

A schedule has been registered.

**NOTE**

- When setting details such as operation mode or set temperature, etc. as a schedule, refer to "Change the Operating Schedule" (P.64).
- When deleting a registered schedule, refer to "Delete the operation schedule" (P.71).

## Create a new special day schedule

In a Special day schedule, you can register special days, such as national holidays and special holidays, to configure a special day schedule that differs from the Weekly schedule.

Schedules can be configured from the group screen or the individual control screen. The following procedure is explained using the individual control screen.

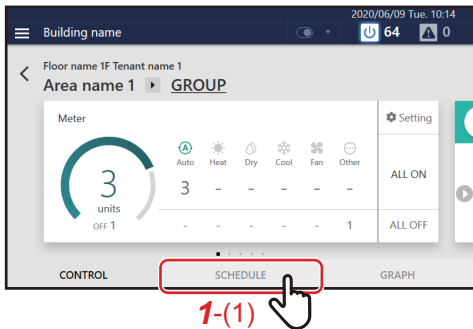

**1** Tap [1-(1)] on the group screen or the individual control screen

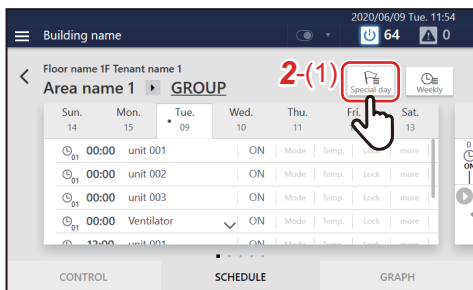

**2** Tap [2-(1)]

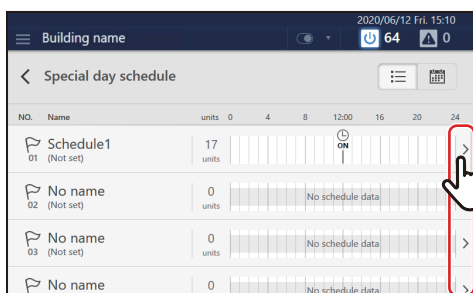

**3** Tap >

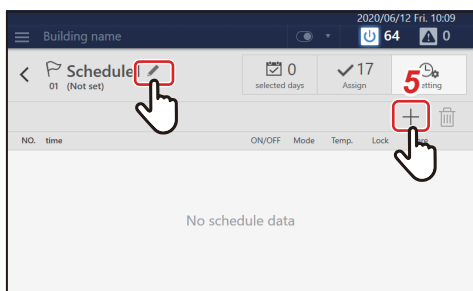

**4** Tap and set the schedule name

A keyboard is displayed. Enter the name and then tap [4-(1)].

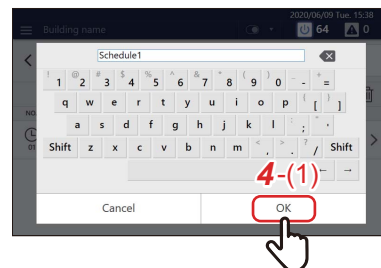

**5** Tap to go to step 6

**NOTE**

- Tap [Shift] to toggle between upper case letters and lower case letters, and numbers and symbols.
- Tap to delete one character.



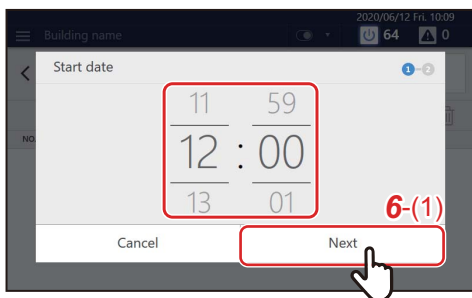

**6** Tap or flick to set the start date, and then tap [6-(1)]



**7** Tap the check box of [7-(1)] and set it to , then select [7-(2)] or [7-(3)] and tap [7-(4)]  
You can only set [ON/OFF] here.

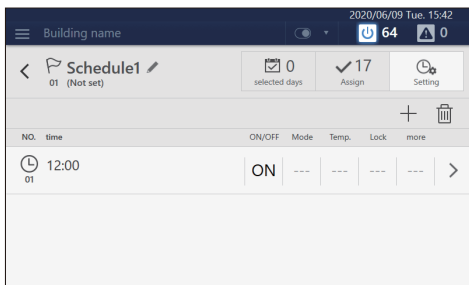

The schedule is registered.

#### NOTE

- When setting details such as the mode or the set temperature to a schedule, refer to "Change the details of the special day schedule" (P.66)
- When deleting a registered schedule, refer to "Delete the operation schedule" (P.71).

## Monitor the Overall Air Conditioning System

To check the operation status of the overall air conditioning system, tap to display the batch ON/OFF screen.  
 To check the malfunction occurrence status, tap to display the check code screen.



No.	Functions
1	Displays the overall number of operating units as ON/OFF meters and numerical values. *
2	Displays the number of units for each operation mode. The upper row shows the number of units in operation and the lower row shows the number of units stopped. * If there is ON/OFF unit, it is displayed in [2-(1)].
3	You can change the operation status of the overall air conditioning system. (P.34) For the Option settings, see step 3 on (P.38).
4	Tap to close the batch ON/OFF screen. <b>NOTE</b> You can also tap   to close.
5	The check code, check content, notice code, notice content, occurrence location, and occurrence time are displayed.
6	Stop operation of all air conditioners and ON/OFF unit where check codes are displayed and erase the check code (s). <b>NOTE</b> For some ON/OFF unit, only the operation stops, and the check code (s) are not erased.
7	Stop the applicable air conditioner(s) or ON/OFF unit and erase the check code (s). <b>NOTE</b> For some ON/OFF unit, only the operation stops, and the check code (s) are not erased.
8	Tap to close the check code screen. <b>NOTE</b> You can also tap   to close.

\* The number of Air to Water Heat Pumps (ATW) of the hot water supply function is not included.

# 7 Various Functions

This section explains detailed settings on the [CONTROL] tab, how to change the schedule on the [SCHEDULE] tab, and how to check the power usage on the [GRAPH] tab.

## Local Remote Controller Lock

You can restrict operation of the local remote controllers that belong to each air conditioner.

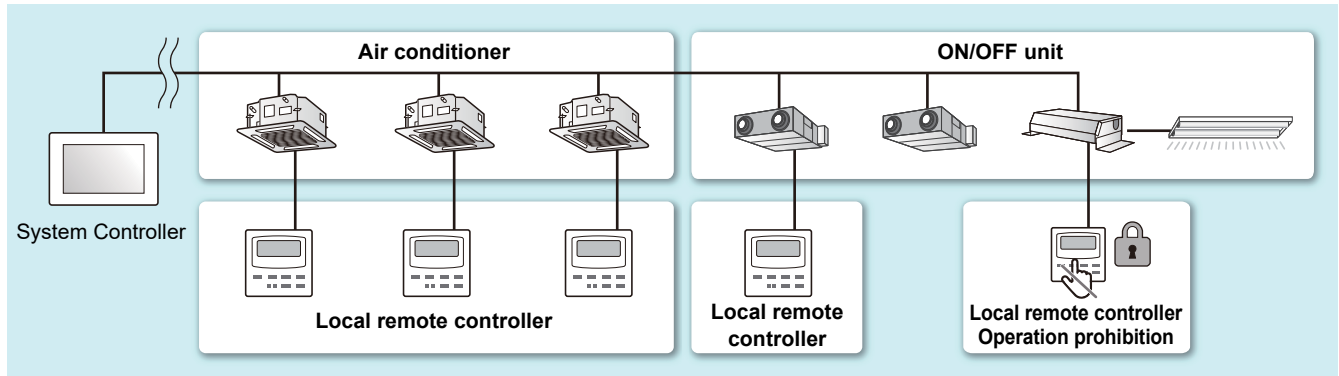

- 1 Display the [CONTROL] tab of the air conditioner(s) whose setting you want to change (P.22, 24) When changing in group units, display the batch settings screen (P.38)

In the following procedure, the [CONTROL] tab of the individual control screen is used to explain.

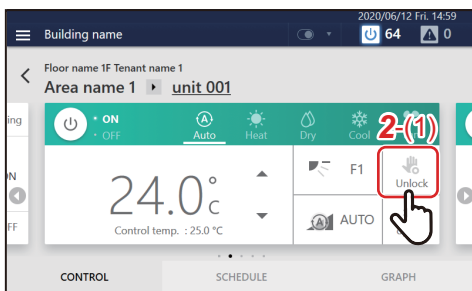

- 2 Tap [2-(1)]

**NOTE**

appears if it is not locked. appears if there is a locked item.

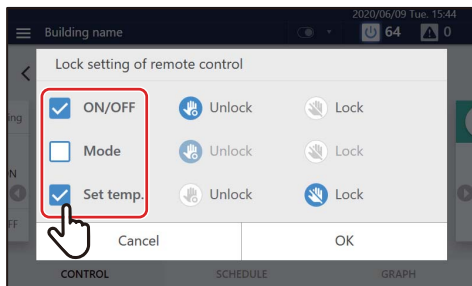

- 3 Tap the check box of the function whose setting you want to change to set it to

**NOTE**

The display items vary depending on the model.

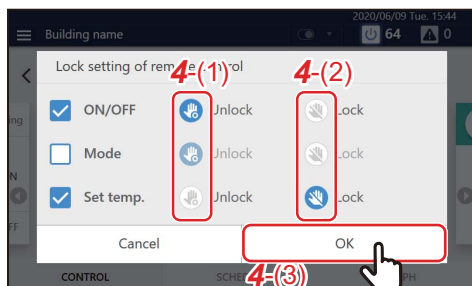

- 4 Select [4-(1)] or [4-(2)], then tap [4-(3)]

**REQUIREMENT**

If you set the check box to  before tapping [4-(3)], the setting will not be applied.

**NOTE**

When local remote control operation is prohibited, if there is a power failure, the local remote control prohibited status will be cancelled when the power returns.

Ask service personnel if you want to continue the local remote control prohibited status after returning from a power failure.

**NOTE**

If you perform an operation that is locked with the local remote controller, the lock screen or a message will be displayed.

**Lock screen example  
(Energy saving neo remote controller)**

**(Wired remote controller)**

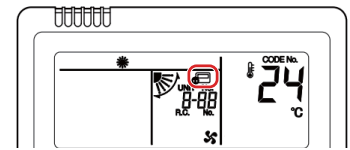
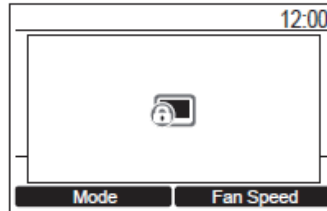

## Set Operation Details

You can check the current settings of the air conditioner(s) or ON/OFF unit, and set the details of the operation method.

- 1 Display the [CONTROL] tab of the air conditioner(s) or ON/OFF unit whose setting you want to change (P.24)  
When changing in group units, display the batch settings screen (P.38)

In the following procedure, the individual control screen is used to explain.

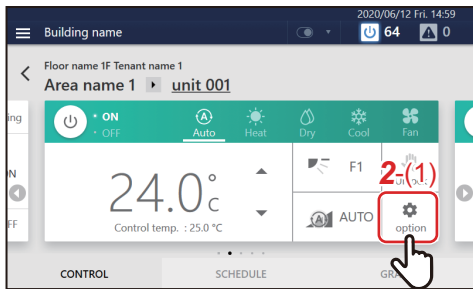

- 2 Tap [2-(1)]

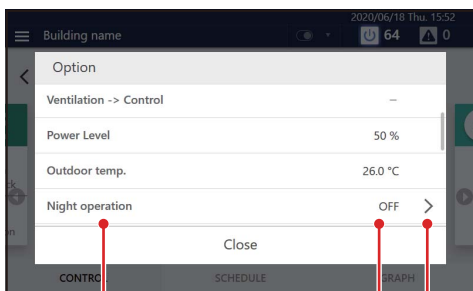

The option screen appears.

1

2

3

No.	Functions
1	The function name appears.
2	The currently set contents are displayed. If the settings are invalid, "-" is displayed.
3	When the settings can be changed, > is displayed. Tap to display the settings screen.

- 3 Scroll up and down to display the items you want to set/check

#### 4 To change, tap > to display the settings screen, then tap [OK] after changing the settings

For details on the confirmation/setting contents of each item, refer to the following. The items displayed depend on the model and state.

### Options for air conditioners

Function Name	Overview	Setting Items	Reference Page
Wind direction (left / right)	You can set the wind direction (left / right).	Swing, E1 - E7, Swing Stop	P.56
Ventilation → ON/OFF	Controls the operation of the ventilator connected to the air to air heat exchanger(s) or the air conditioner(s).	ON/OFF	P.56
Ventilation → Mode	Controls the ventilation mode of the ventilator connected to the air to air heat exchanger(s) or the air conditioner(s).	Bypass/Heat exchange/Automatic	P.56
Ventilation → Fan speed	Controls the operation of the ventilator connected to the air to air heat exchanger(s) or the air conditioner(s).	Low, Medium, High, Unbalance Low, Unbalance High, Auto	P.56
Ventilation → Control	24-hour ventilation/Nighttime heat purge	–	–
Power Level	You can monitor the output status of the air conditioner(s).	–	P.57
Outdoor temp.	You can monitor the outdoor temperature detected by the outdoor unit.	–	P.57
Humidification setting	The humidification setting of the indoor unit can be set.	Auto, Disable	
Excessive CO <sub>2</sub> setting	Settings of CO <sub>2</sub> concentration excess and threshold can be set. If the setting is enabled, Check Code S36 is generated when the CO <sub>2</sub> concentration exceeds the threshold.	Setting: Enable, Disable Threshold: 100 ppm to 3000 ppm * Can be set in units of 100 ppm	
Night operation setting (VRF, LC, ESTIA)	Outdoor units can be set to low sound.	ON/OFF	P.57
Night operation setting (RAC)	Outdoor units can be set to low sound.	OFF, Night operation 1, Night operation 2	P.57
Filter sign reset	You can clear the FILTER Sign. You can clear the Hour.	OK/Cancel	P.58
Inspection	You can check the check code that has occurred.	–	–
Soft Cooling	You can set to Middle COOL.	ON/OFF	P.58
Energy saving ratio [%]	You can control the cooling/heating output of the air conditioner(s).	Release (100%)/Max.(50 - 100%)/50/0	P.58
Saving operation	You can operate the indoor unit by saving the power.	ON/OFF	P.58
Forced Thermo OFF	You can release Thermo OFF.	Invalid	P.58
Return Back	You can control Return Back.	Cool (release, enable), Heat (release, enable)	P.59
Power peak cut	You can monitor whether the outdoor unit is controlling demand.	–	P.59
Eco Temperature Shift	You can set whether to change (shift) the set temperature.	OK/Cancel	P.59
Frost protection	Frost protection can be controlled.	ON/OFF	P.59
Set temp. range limit	You can change the set temperature range for each operation mode.	18°C to 29°C * It may differ depending on the region and model.	P.60
HiPower	HiPower can be controlled.	ON/OFF	P.60
ECO	ECO can be controlled.	ON/OFF	P.60
Power Select	Power Select can be controlled.	50%, 75%, 100%	P.61
PURE	PURE can be controlled.	ON/OFF	P.61
Fireplace	Fireplace can be controlled.	OFF, Fireplace 1, Fireplace 2	P.61
Notice Code	Displays Notice Codes that occur during operations.	–	P.61
Check Code (During backup operation)	Displays Check Codes that occur during backup operations.	–	P.61
Unit information	Unit information can be confirmed.	–	P.62

**Options for Air to Water Heat Pump (ATW)**

Function Name	Overview	Setting Items	Reference Page
Auto mode	Auto mode can be controlled.	ON/OFF	P.62
Night set back	Night set back can be allowed.	Enable/Disable	P.62
Night operation setting (VRF, LC, ESTIA)	Outdoor units can be set to low sound.	ON/OFF	P.57
Hot water boost	Hot water boost can be controlled.	ON/OFF	P.62
Anti bacteria	Antibacterial can be allowed.	Enable/Disable	P.63
Frost protection	Frost protection can be controlled.	ON/OFF	P.59
ESTIA information	Shows the following operating statuses. Boiler operation, Comp operation, DHW heater, Heater, Pump 1 operation, Pump 2 operation	–	P.63
Check Code (During backup operation)	Displays Check Codes that occur during backup operations.	–	P.61
Unit information	Unit information can be confirmed.	–	P.62

## Set the wind direction (left / right)

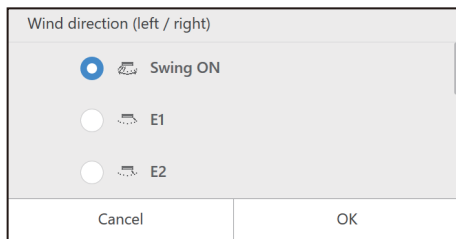

If the connected indoor unit has a vertical flap, you can set the wind direction (left / right).

### NOTE

Depending on the connected model, it may not be configurable.

## Turn ON/OFF the ventilation function



You can turn ON/OFF the operation of the ventilator connected to the air conditioner(s).

### NOTE

Depending on the connected model, it may not be configurable.

## Set ventilation mode

You can set the ventilation mode of the ventilator connected to the air to air heat exchanger(s) or the air conditioner(s). The settings screen displayed differs depending on the setting state of [Ventilation → ON/OFF].

### When [ON] is selected under [Ventilation → ON/OFF]

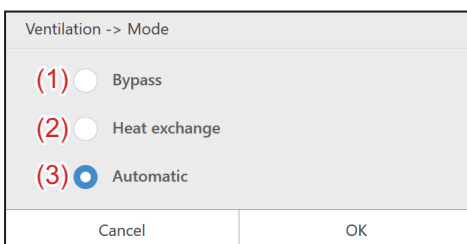

- |                    |                                                                                                                                                                          |
|--------------------|--------------------------------------------------------------------------------------------------------------------------------------------------------------------------|
| (1) Bypass:        | Outdoor air is taken into a room as it is.                                                                                                                               |
| (2) Heat exchange: | Exchanging heat between the outdoor air and return air and making the temperature and humidity of the outdoor air closer to those of the return air before supplying it. |
| (3) Automatic:     | Total Heat Ventilation and Bypass Ventilation are switched automatically.                                                                                                |

### NOTE

Depending on the connected model, some or all items may not be configurable.

## Setting the ventilation fan speed

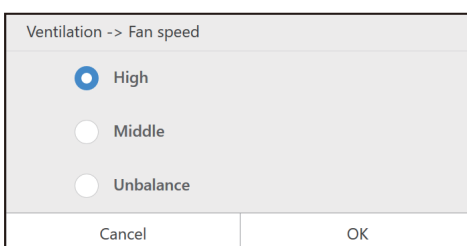

You can set the ventilation fan speed of the ventilator connected to the air to air heat exchange unit or the air conditioner. The choices displayed depend on the model.

### NOTE

- Depending on the connected model, it may not be configurable.
- It is displayed when [Ventilation → ON/OFF] is [ON] and setting change is possible.

\* Details for unbalance settings vary depending on the settings of the connected model.



### Check the output status of the air conditioner(s)

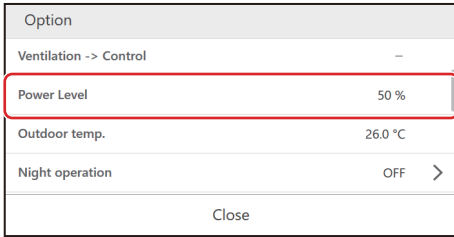

You can check how much power the air conditioner is using for operation.

**NOTE**

Depending on the connected model, it may not be displayed.

### Check the outdoor temperature detected by the outdoor unit

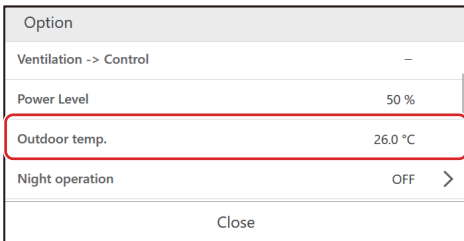

You can check the outdoor temperature detected by the outdoor unit.

**NOTE**

- Depending on the connected model, it may not be displayed.
- Depending on conditions such as the location of the outdoor unit installation, it may differ from the actual outdoor temperature.

### Set humidification

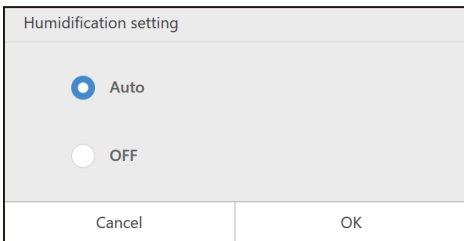

The humidification setting of the air conditioning can be set.

**NOTE**

- Depending on the connected model, it may not be displayed.
- Under automatic humidification, humidification is ON/OFF automatically according to the indoor environment.

### Set the CO<sub>2</sub> concentration excess setting

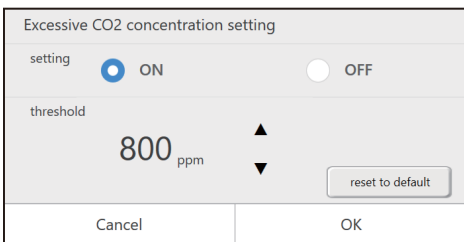

Settings of CO<sub>2</sub> concentration excess and threshold can be set. If the setting is enabled, Check Code S36 is generated when the CO<sub>2</sub> concentration exceeds the threshold.

**NOTE**

Depending on the connected model, it may not be displayed.

### Make the night operation setting for the outdoor unit

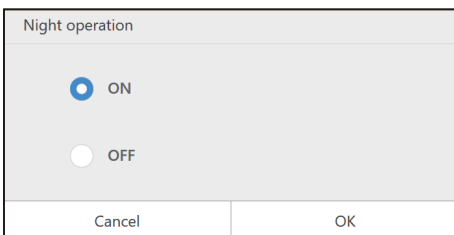

Monitor and control the ON or OFF state of the night operation of the target device.

This  is displayed to the right of the name when Night operation is in progress.

**NOTE**

- Depending on the connected model, it may not be displayed.
- When Night Operation is set, turn on the Silent Mode setting of the Hydro Unit to operate the Air to Water Heat Pump.

## Filter sign Reset

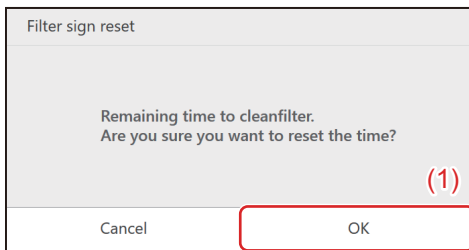

When a device has operated for a certain period of time, a warning (Filter sign) is displayed to indicate that the filter should be cleaned. After filter cleaning, tap [(1)].

### NOTE

- Depending on the connected model, it may not be displayed.
- If you set the air conditioners where a sign is displayed to [OK], the cumulative time for the sign display is set to 0.

## Set Soft Cooling

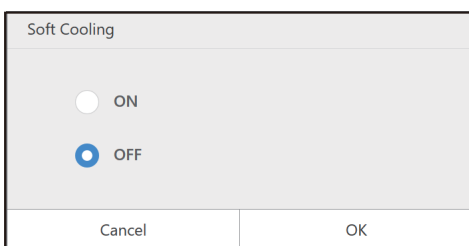

Soft Cooling can be turned ON/OFF. When turned ON, the air direction is set to up, and the maximum power is restricted.

### NOTE

- Depending on the connected model, it may not be displayed.
- The settings screen is displayed when the air conditioner is in operation and the operation mode is COOL.

## Control air conditioner power

An energy saving function whereby you can operate the air conditioner with suppressed cooling/heating power.

Release (100%): Save Mode is not performed.

Max.(50 - 100%): Operate with the highest save rate.

50: Operate at 50% save rate.

0: Operate at 0% cooling/heating power (Thermo OFF).

### NOTE

Depending on the connected model, it may not be displayed.

## Set saving operation

With one of the energy-saving functions, monitor and control the Valid or Invalid state of the saving operation of the air conditioner.

### NOTE

Depending on the connected model, it may not be displayed.

## Release thermo OFF

"Thermo OFF" refers to an energy saving function that controls demand to restrict the cooling/heating power of the air conditioner such that the outdoor unit compressor is stopped. When this state is reached, the air conditioner becomes a fan and cold/hot air is no longer output.

To release Thermo OFF, display the settings screen and press [OK].

### NOTE

Depending on the connected model, it may not be displayed.

### Configure and confirm the Return Back settings

You can configure and check the Return Back setting temperature and setting time of each operation mode that are set in the operating schedule.

**NOTE**

- Depending on the connected model, it may not be displayed.
- For information on Return Back, see “Return Back settings” (P.68).

### Monitor power peak cut of outdoor unit

You can monitor the power peak cut, outdoor line No., and schedule No. of the outdoor unit connected to the selected air conditioner.

Display the settings screen to check the power peak cut status of the outdoor unit.

**NOTE**

Depending on the connected model, it may not be displayed.

### Change to energy saving temperature

An energy saving function that changes (shifts) the set temperature according to the current operation mode as follows.

Operation Mode	Set Temperature Shift Width
Cool/Dry	Current set temperature +2°C shift
Heat	Current set temperature -2°C shift
Auto/Fan	Remain at current set temperature

**NOTE**

Depending on the connected model, it may not be displayed.

### Frost protection

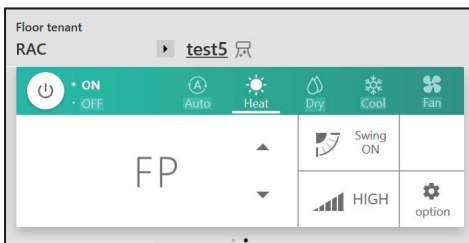

This function monitors and controls frost protection.

Frost protection can only be set when heating is on.

FP is displayed in the place that the set temperature is displayed while frost protection is operating.

Frost protection is disabled by the following operations, unless disabled from the frost protection settings.

- Indoor unit is turned off.
- Operation mode is changed to something other than heating.
- Set temperature is changed.

**NOTE**

May not be displayed, depending on the model connected.

## Set the temperature change range

You can set the set temperature range for each operation mode.

### NOTE

- Depending on the connected model, it may not be displayed.
- If the current set temperature of the air conditioner is outside of the set temperature range after the change, it will be changed to the temperature within the range after the change.
- If you use wireless remote controller, wireless remote controller may set a temperature outside the set temperature range specified by the Unit.

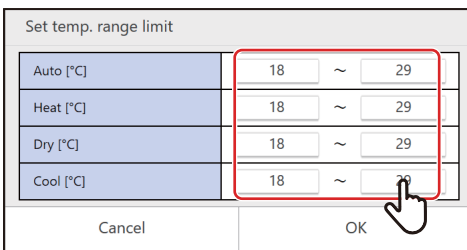

### 1 Tap the upper/lower limit temperature you want to change

#### NOTE

Depending on the connected model, it may not be configurable.

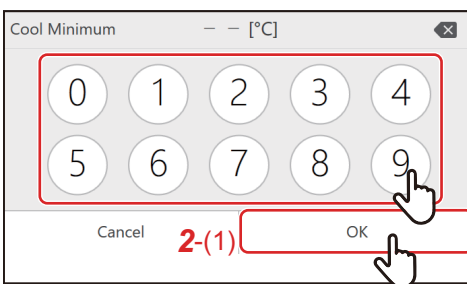

### 2 Tap the number, enter the temperature, and tap [2-(1)]

## HiPower

This function monitors and controls HiPower operation of targeted equipment. While being controlled,  is displayed to the right of the unit name.

### NOTE

May not be displayed, depending on the model connected.

## ECO

This function monitors and controls ECO operation of targeted equipment. While being controlled,  is displayed to the right of the unit name.

### NOTE

May not be displayed, depending on the model connected.

## Power Select

This function monitors and controls Power select operation of targeted equipment. While being controlled,  is displayed to the right of the unit name.

- **NOTE**

May not be displayed, depending on the model connected.



## PURE

This function monitors and controls PURE operation of targeted equipment. While being controlled,  is displayed to the right of the unit name.

- **NOTE**

May not be displayed, depending on the model connected.

## Fireplace

This function monitors and controls Fireplace operation of targeted equipment. While being controlled,  /  is displayed to the right of the unit name.

- **NOTE**

May not be displayed, depending on the model connected.

## Notice Code

Displays Notice Codes that occur during operations.

- **NOTE**

May not be displayed, depending on the model connected.

## Check Code (During backup operation)

Displays Check Codes that occur during backup operations.

- **NOTE**

May not be displayed, depending on the model connected.

## Unit information

Displays the model name and production number.

### • NOTE

May not be displayed, depending on the model connected.

## Auto mode

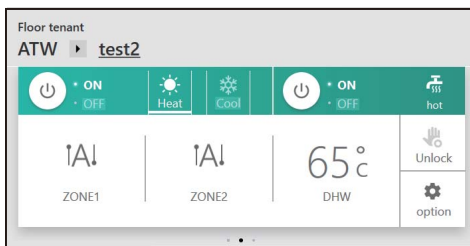

This function monitors and controls Auto mode.

By setting Auto mode to [Enable], |A| is displayed where the temperature setting is displayed, and the temperature setting cannot be changed.

### • NOTE

May not be displayed, depending on the model connected.

## Night set back

This function monitors and controls Night set back.

While being controlled, 🌙 is displayed to the right of the unit name.

### • NOTE

May not be displayed, depending on the model connected.

## Hot water boost

This function monitors and controls Hot water boost.

While being controlled, 🔥 is displayed to the right of the unit name.

The actual operation depends on the time at the local remote control.

For details, refer to the owner's manual for the local remote control.

### • NOTE

May not be displayed, depending on the model connected.

## Anti bacteria

Monitors and controls Anti bacteria operation.

While being controlled,  is displayed to the right of the unit name.

The actual operation depends on the time at the local remote control.

For details, refer to the owner's manual for the local remote control.

### ● NOTE

May not be displayed, depending on the model connected.

---

## ESTIA information

Shows the following operating statuses.

- Boiler operation
- Comp operation
- DHW heater
- Heater
- Pump 1 operation
- Pump 2 operation

### ● NOTE

May not be displayed, depending on the model connected.

---

## Change the Operating Schedule

The operating schedule settings can be changed from the [Menu] button, the group screen, or the individual control screen. There are two types of operating schedules: Weekly schedule and Special day schedule. The following procedure is explained using the individual control screen.

**NOTE**

If a day is set in both the Weekly schedule and the Special day schedule, the Special day schedule applies and the Weekly schedule is disabled for that day.

### Change the details of the weekly schedule

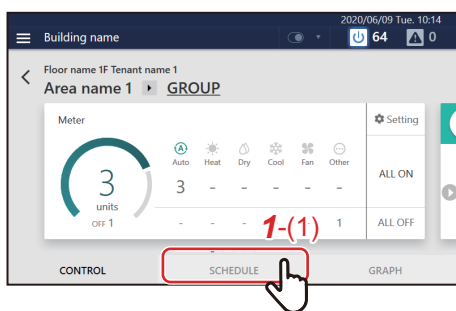

**1** Tap [1-(1)] on the group screen or the individual control screen

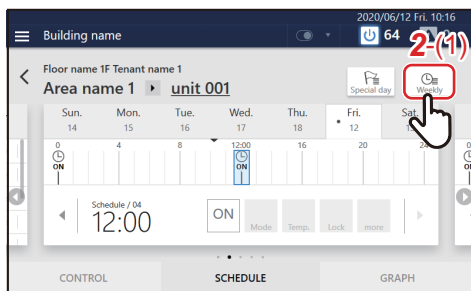

**2** Tap [2-(1)]

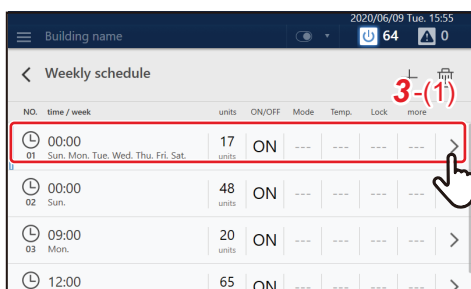

**3** Tap [3-(1)] of the schedule you want to modify



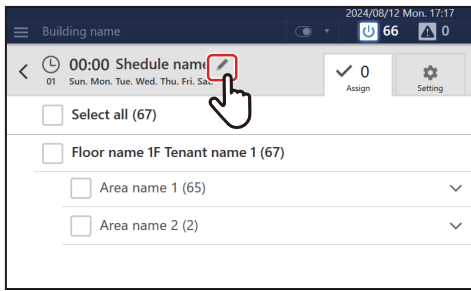

**4 Tap  and set the schedule name**

A keyboard is displayed. Enter the name and then tap [4-(1)].

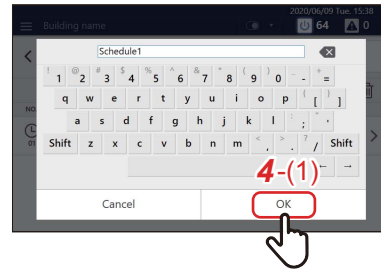

**NOTE**

- Tap [Shift] to toggle between upper case letters and lower case letters, and numbers and symbols.
- Tap  to delete one character.

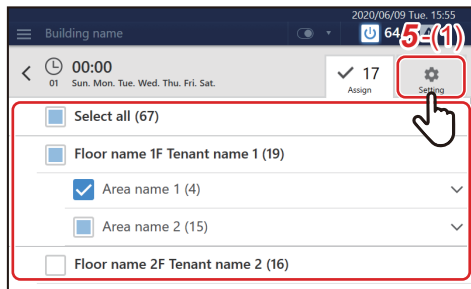

**5 Modify the target air conditioner(s) or ON/OFF unit, then tap [5-(1)]**

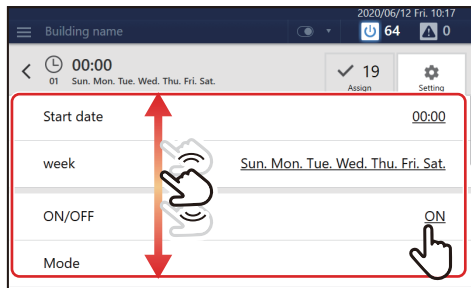

**6 Scroll the screen and tap the value of the item you want to set. After changing the setting, tap [OK]**  
See "Setting items list" (P.68) for the items that can be configured.

**Change the details of the special day schedule**

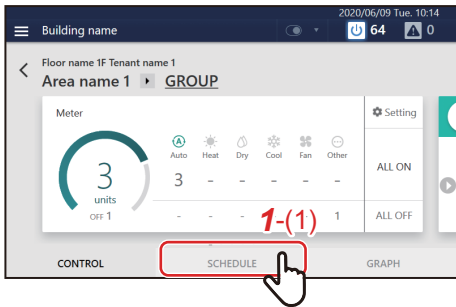

**1** Tap [1-(1)] on the group screen or the individual control screen

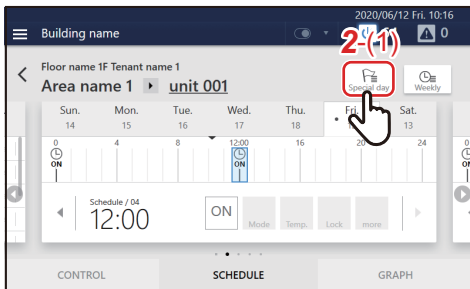

**2** Tap [2-(1)]

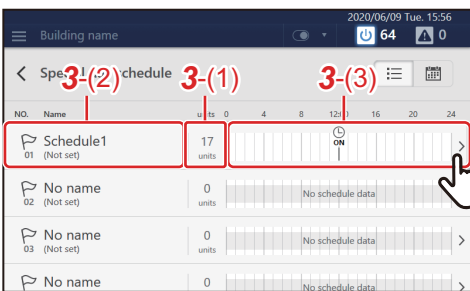

**3** Tap [3-(1)] of the schedule you want to modify

- [3-(1)] Unit setting: Go to step 4
- [3-(2)] Special day setting: Go to step 5
- [3-(3)] Operating schedule setting: Go to step 6

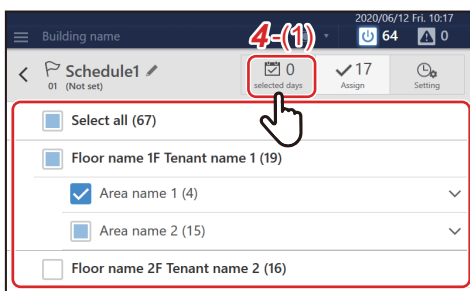

**4** Modify the target air conditioner(s) or ON/OFF unit, then tap [4-(1)]

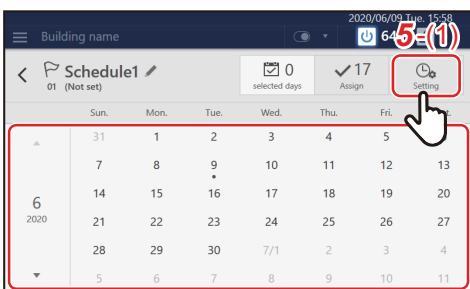

**5** Tap the date you want to configure, modify the settings, and then tap [5-(1)]

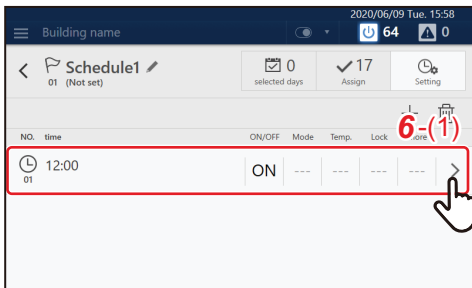

**6 Tap [6-(1)] of the time you want to modify**

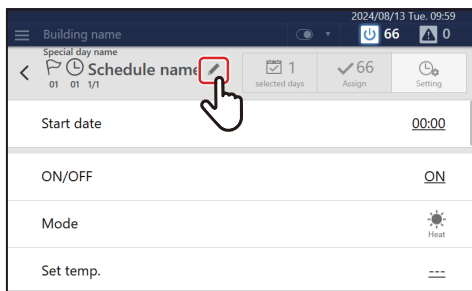

**7 Tap [edit icon] and set the schedule name**

A keyboard is displayed. Enter the name and then tap [7-(1)].

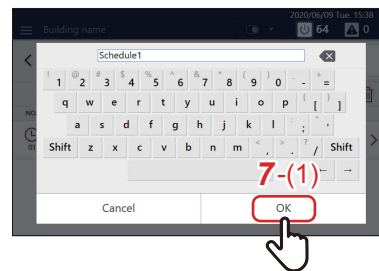

**NOTE**

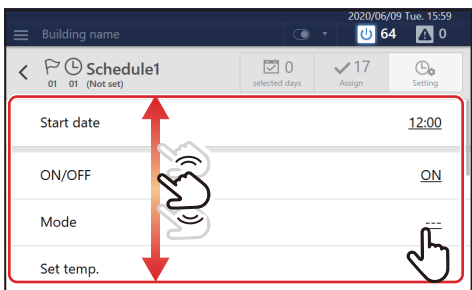

- Tap [Shift] to toggle between upper case letters and lower case letters, and numbers and symbols.
- Tap [X] to delete one character.



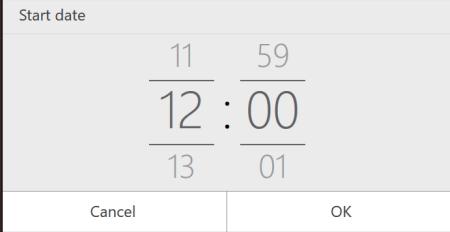
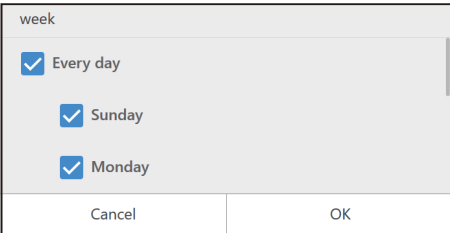

**8 Scroll the screen and tap the value of the item you want to set. After changing the setting, tap [OK]**

See "Setting items list" (P.68) for the items that can be configured.

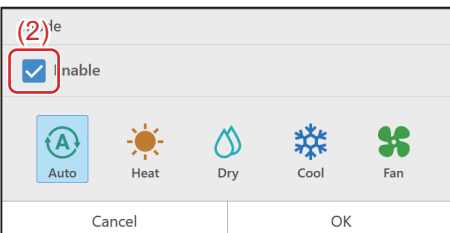
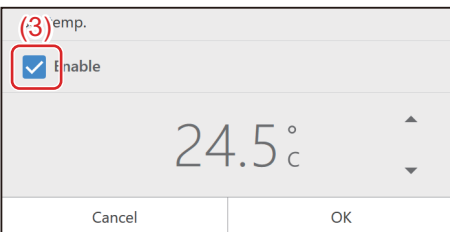
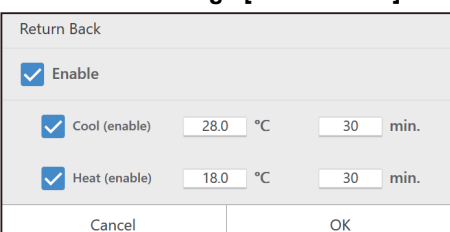
**Setting items list**

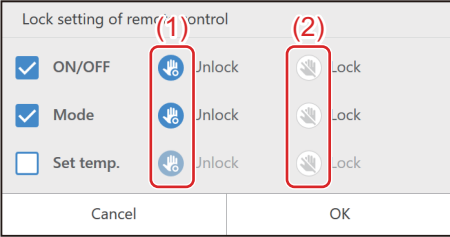
Setting Items	Setting Procedure
<p><b>Time setting [Start date]</b></p> 	<p>Tap or flick to change the time.</p>
<p><b>Day of the week setting [week]</b></p> 	<p>Set the check box(es) of the day(s) of the week on which you want to execute the schedule to <input checked="" type="checkbox"/>.</p> <p><b>NOTE</b></p> <p>The day of the [week] setting is not displayed in Special day schedule.</p>
<p><b>Operation setting [ON/OFF]</b></p> 	<p>To enable the setting, set the check box of [(1)] to <input checked="" type="checkbox"/> and select a value.</p> <p><b>NOTE</b></p> <p>Hot water supply function of the ATW cannot be set to [ON, OFF] by this setting.</p>
<p><b>Operation mode setting [Mode]</b></p> 	<p>To enable the setting, set the check box of [(2)] to <input checked="" type="checkbox"/> and select a value.</p>
<p><b>Set temperature setting [Set temp.]</b></p> 	<p>To enable the setting, set the check box of [(3)] to <input checked="" type="checkbox"/>, tap ▲ ▼, then change the set temperature.</p>
<p><b>Return Back settings [Return Back]</b></p> 	<p>An energy saving function whereby if you temporarily change the set temperature to one which increases the load, you can automatically return to the energy saving set temperature after a certain time has elapsed. For example, if you set COOL to 28°C/30 minutes, then if the set temperature is set to below 28°C, the Unit will return to 28°C 30 minutes after the change.</p> <p><b>NOTE</b></p> <p>Displayed in the case of a compatible air conditioner.</p>

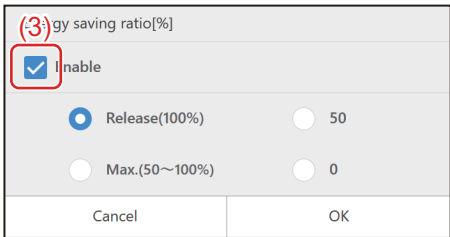
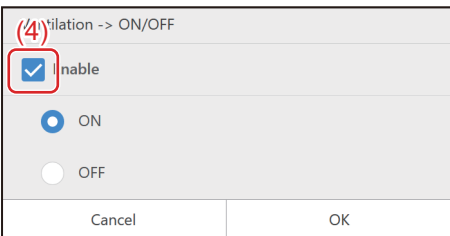
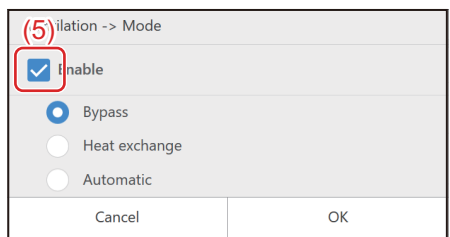
Setting Items	Setting Procedure
<p><b>Local operation prohibition setting</b> <b>[Lock setting of remote control]</b></p> 	<p>Tap the check box of the function whose setting you want to change to set it to <input checked="" type="checkbox"/>, then select [(1)] or [(2)].</p>
<p><b>Night operation setting</b> <b>[Night operation]</b></p> 	<p>You can change the [ON/OFF] of the night operation of the target device.</p>
<p><b>Save operation setting</b> <b>[Energy saving ratio[%]]</b></p> 	<p>To enable the setting, set the check box of [(3)] to <input checked="" type="checkbox"/>. For details, see "Control air conditioner power" (P.58).</p>
<p><b>Ventilation operation setting</b> <b>[Ventilation -&gt; ON/OFF]</b></p> 	<p>You can turn ON/OFF the operation of the ventilator connected to the air conditioner(s). To enable the setting, set the check box of [(4)] to <input checked="" type="checkbox"/> and apply the setting.</p> <p><b>NOTE</b></p> <p>Set the ventilation of the air to air heat exchanger connected individually from the operation setting [ON/OFF].</p>
<p><b>Vent. Mode</b> <b>[Ventilation -&gt; Mode]</b></p> 	<p>You can set the ventilation mode of the ventilator connected to the air to air heat exchanger(s) or the air conditioner(s). To enable the setting, set the check box of [(5)] to <input checked="" type="checkbox"/> and apply the setting. For details, see "Set ventilation mode" (P.56).</p>

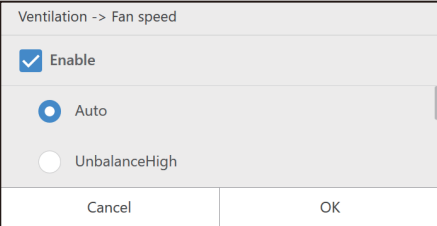
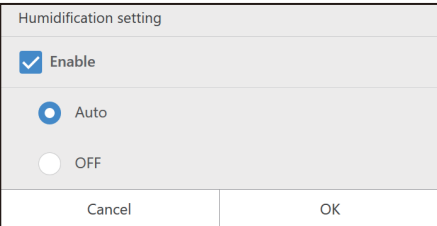
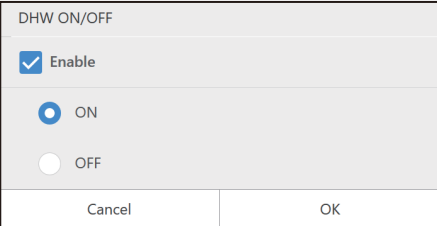
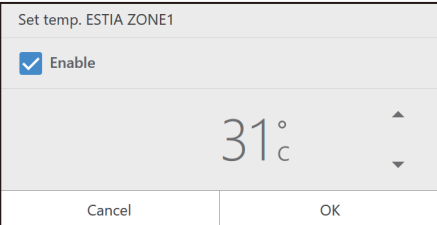
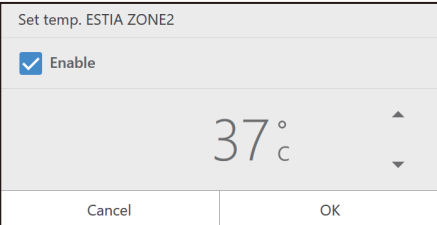
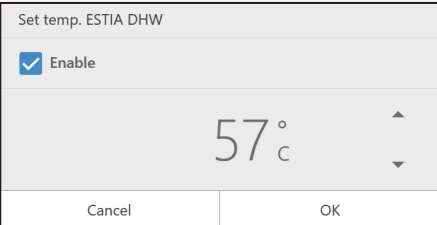
Setting Items	Setting Procedure
<p><b>Ventilation → Fan speed</b></p> 	<p>You can set the ventilation fan speed of the ventilator connected to the air to air heat exchange unit or the air conditioner.</p> <p>* Details for unbalance settings vary depending on the settings of the connected model. To enable the setting, set the check box of [Enable] to <input checked="" type="checkbox"/> and apply the setting. For details, see "Setting the ventilation fan speed" (P.56).</p>
<p><b>Humidification setting</b></p> 	<p>The humidification setting of the air conditioning can be set. To enable this setting, select <input checked="" type="checkbox"/> for the [Enable] checkbox, and then select [Auto/OFF].</p>
<p><b>DHW ON/OFF</b> [DHW ON/OFF]</p> 	<p>This setting item is specifically for the Air to Water Heat Pump (ATW) in the hot water supply function.</p> <p>To enable this setting, select <input checked="" type="checkbox"/> for the [Enable] check box, and then select [ON, OFF].</p> <p><b>NOTE</b></p> <p>Indoor units, ON/OFF units, and the air conditioning function of the ATW cannot be set to [ON, OFF] by this setting.</p>
<p><b>ZONE1 Set temp.</b> [Set temp. ESTIA ZONE1]</p> 	<p>This setting item is specifically for the Air to Water Heat Pump (ATW) in the air conditioning function.</p> <p>To enable this setting, select <input checked="" type="checkbox"/> for the [Enable] check box, and then tap ▲ ▼ to change the set temperature.</p> <p>The set temperature cannot be changed in increments of 0.5°C.</p>
<p><b>ZONE2 Set temp.</b> [Set temp. ESTIA ZONE2]</p> 	<p>This setting item is specifically for the Air to Water Heat Pump (ATW) in the air conditioning function.</p> <p>To enable this setting, select <input checked="" type="checkbox"/> for the [Enable] check box, and then tap ▲ ▼ to change the set temperature.</p> <p>The set temperature cannot be changed in increments of 0.5°C.</p>
<p><b>Hot water setting temperature</b> [Set temp. ESTIA DHW]</p> 	<p>This setting item is specifically for the Air to Water Heat Pump (ATW) in the hot water supply function.</p> <p>To enable this setting, select <input checked="" type="checkbox"/> for the [Enable] check box, and then tap ▲ ▼ to change the set temperature.</p> <p>The set temperature cannot be changed in increments of 0.5°C.</p>

## Delete the operation schedule

You can delete the schedule from either the group screen or the individual control screen. In the following procedure, the individual control screen is used.

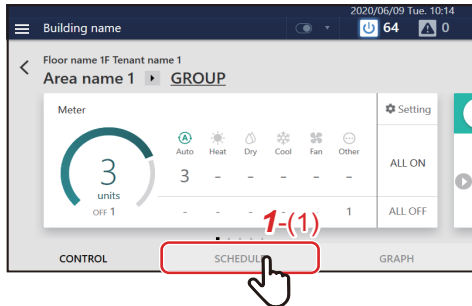

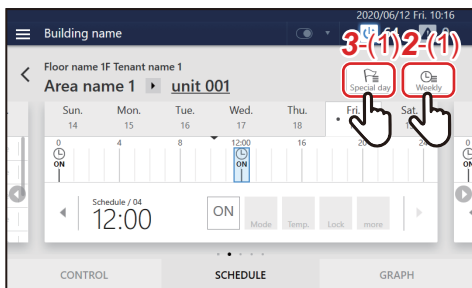

**1** Tap [1-(1)] on the group screen or individual control screen

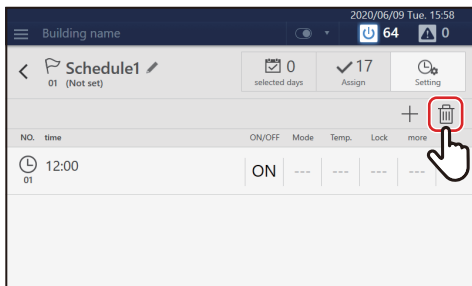
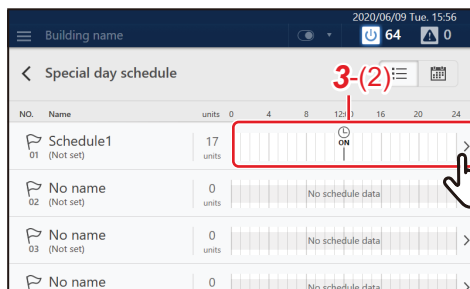

**2** Tap [2-(1)] to go to step 4

**3** (In case of Special day setting) tap [3-(1)]  
Tap [3-(2)] of the schedule you want to modify to go to step 4.



**4** Tap   
(Some displayed items differ between the Weekly schedule screen and the Special day schedule screen, but the procedure shown below is the same.)

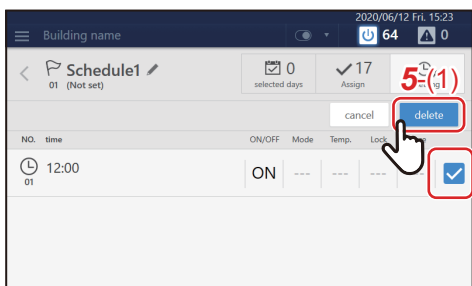

**5** Set the check box of the schedule you want to delete to   
then tap [5-(1)]

## Confirm the Operation Time

In the [GRAPH] tab of the group screen or individual control screen, you can check the operation time for each group, air conditioner or ON/OFF unit.

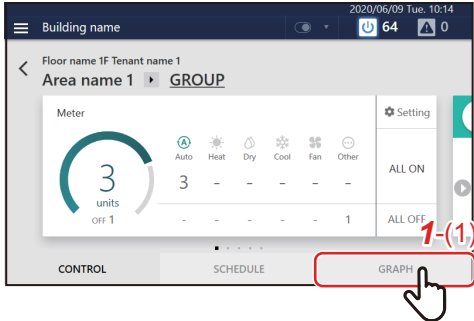

### 1 Tap [1-(1)] on the group screen or individual control screen

The operation graph appears.

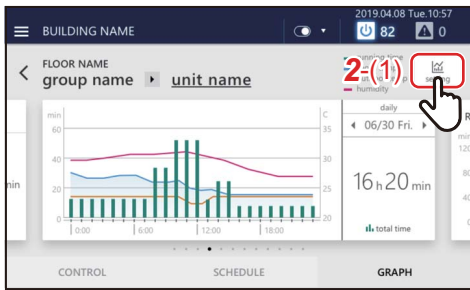

### 2 Tap [2-(1)]

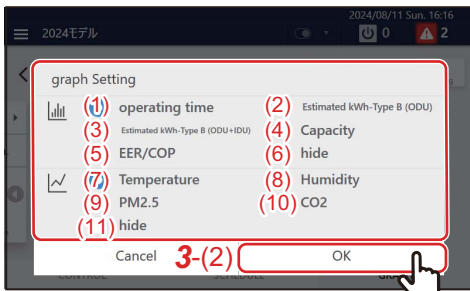

### 3 Select a graph to display and tap [3-(2)]

Selected operation graph appears.

- (1) operating time:
- (2) Estimated kWh-Type B (ODU):
- (3) Estimated kWh-Type B (ODU+IDU):
- (4) Capacity:
- (5) EER/COP:
- (6) hide: (Bar graph)
- (7) Temperature:
- (8) Humidity:
- (9) PM2.5:
- (10) CO2:
- (11) hide: (Line graph)

\* (2) (3) (4) (5) are displayed when "Extend Display Setting for Energy monitor and Unit graph" is set to Display in SFC2.



**Group screen**

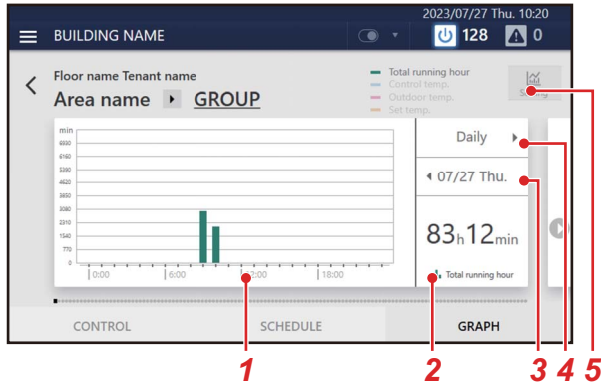

**Individual control screen**

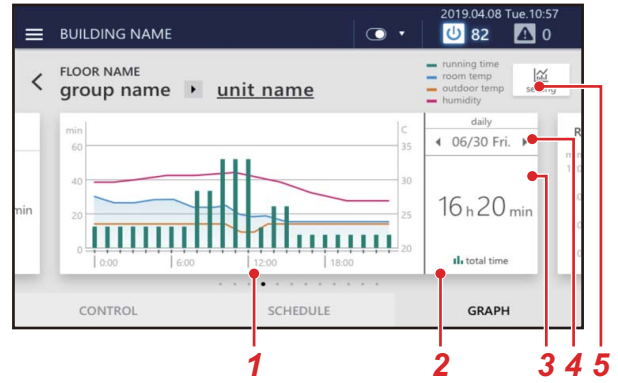

No.	Functions
1	The items selected from [Operating Time], [Estimated kWh-Type B (ODU)], [Estimated kWh-Type B (ODU+IDU)], [Capacity], and [EER/COP] of the air conditioner are displayed as an hourly or daily bar graph. * For the individual control screen, items selected from the temperature (outdoor temperature, room temperature, set temperature), humidity, CO <sub>2</sub> and PM2.5 are displayed in a line graph. The graph may not be displayed depending on the model connected.
2	The operation hours for the displayed summary period is displayed. * Estimated kWh-Type B (ODU, ODU+IDU): Accumulation value Capacity, EER/COP: Average
3	Displays the currently displayed date. Tap ◀ ▶ to switch the date. Tap the centre to select the display period from the calendar screen.
4	You can change the summary unit to day or month.
5	The legend for the graph appears.

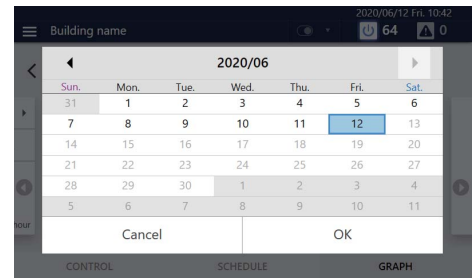

\* The time that the Air to Water Heat Pump (ATW) is operating only as a hot water supply function is not included in the operating time graph.

## Display the Owner's Manual on the Screen

You can browse the owner's manual on the screen.

### How to display the owner's manual

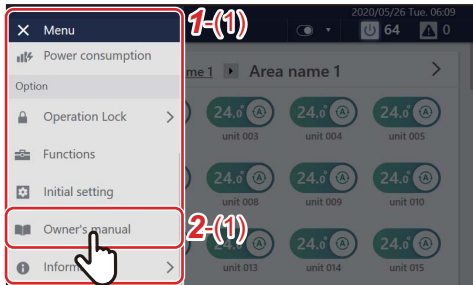

**1** Tap [1-(1)] appears.

**2** Tap [2-(1)]

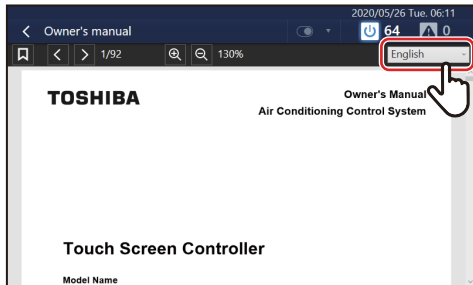

**3** Select the display language  
The owner's manual is displayed.

### Owner's manual screen description





No.	Name (Icon)	Functions
1	Bookmark	You can switch bookmarks between display and non-display.
2	Previous page	Displays the previous page.
3	Next page	Displays the next page.
4	Enlarge, reduce	Used to enlarge and reduce the display.
5	Language selection	Select the display language.
6	Bookmark list	Displays the title of each chapter. Tap a title to display the relevant page.

## Display the open source software license on the screen

On the screen, you can view the open source software license used by this product.

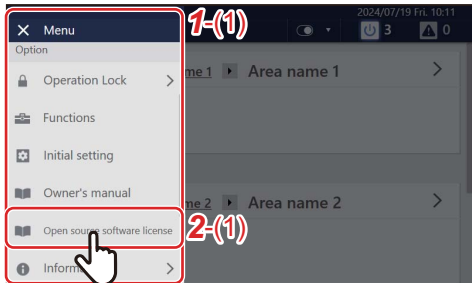
### How to display the open source software license



**1** Tap   
[1-(1)] appears.

**2** Tap [2-(1)]  
The open source software license used is displayed.  
You can see other licenses by scrolling the screen.

# 8 Administrator Menu

## Confirm Check Code History

You can display failures that have occurred in a list, including currently occurring ones. This can be used for grasping the status of the site such as investigating the cause of a failure and the recovery status.

**NOTE**

The past 1,000 check codes are displayed.

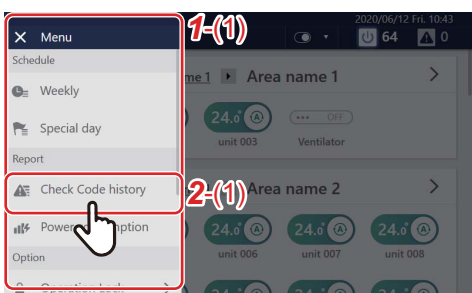

- 1 Tap [1-(1)] appears.
- 2 Tap [2-(1)]

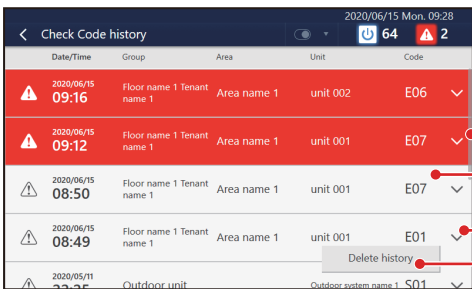

The detected check codes are listed in chronological order.

- Currently occurring check codes are displayed with a red.
- Past check codes are displayed with a white background.
- Tap to display the details of the check code contents.
- You can delete the check code history.

## Confirm Notice Code History

You can display notices that have occurred in a list, including currently occurring ones. For details, confirm with the dealer.

## Confirm the Energy Monitor

You can graph the following values for a visual check.

- Real kWh
- Capacity
- Estimated kW
- EER/COP

\* The estimated kW, capacity, EER/COP display, and some display functions are displayed only when the central controller, outdoor units, indoor units, and remote controller all support this function. Please check with each retailer for details on compatible models.

### Confirm the Real kWh on a graph

\* This function can be displayed when the electric power is measured by connecting this Unit to a pulse transmission type watt hour meter.

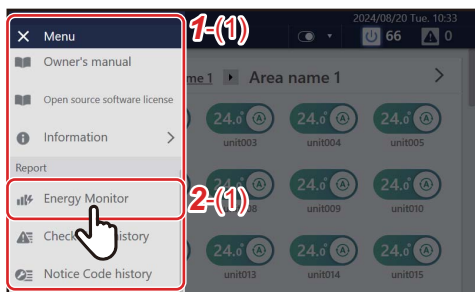

**1** Tap [1-(1)] appears.

**2** Tap [2-(1)]



**3** Tap the data type to be displayed

Tap [3-(1)] and select [WHM].

Tap [3-(2)] to select the unit for the aggregation method of the graph to display.

Tap [3-(3)] to select the unit period for the aggregation method of the graph to display.

Tap [3-(4)] to select the date or month for the graph to display.

In [3-(5)], you can select the graph content to display.

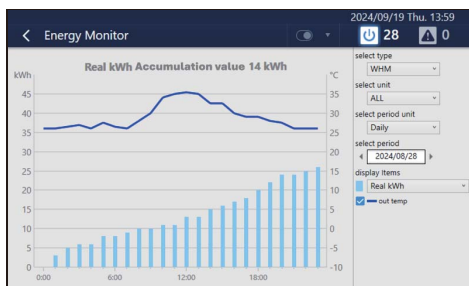

A graph reflecting your settings is displayed.

### Confirm the estimated kW, capacity, and EER/COP on a graph

This function is displayed when "Extend Display Setting for Energy monitor and Unit graph" is set to Display in SFC2.

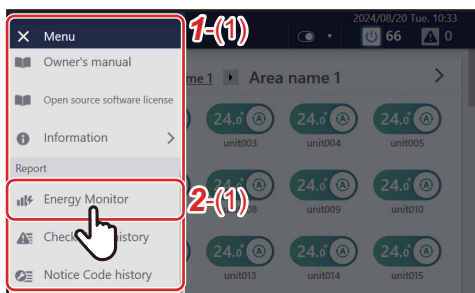

**1** Tap [1-(1)] appears.

**2** Tap [2-(1)]

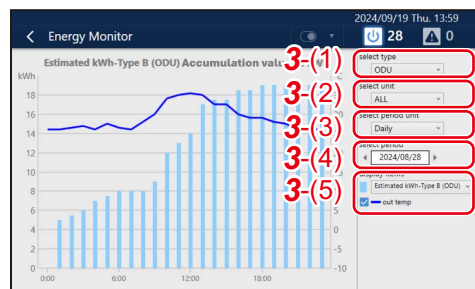

**3** Tap the data type to be displayed

Tap [3-(1)] and select [ODU].

Tap [3-(2)] to select the unit for the aggregation method of the graph to display.

Tap [3-(3)] to select the unit period for the aggregation method of the graph to display.

Tap [3-(4)] to select the date or month for the graph to display.

In [3-(5)], you can select the graph content to display.

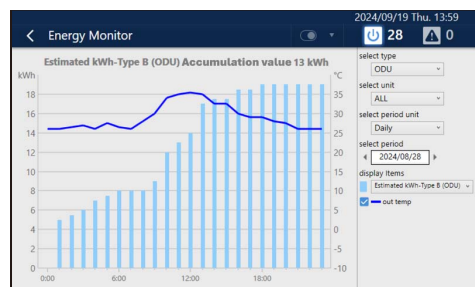

A graph reflecting your settings is displayed.

\* There are two methods to calculate the estimated power consumption: Method A and Method B. Method B has two variations: one calculates the estimated power consumption only for the outdoor units (ODU), and the other calculates it for both the outdoor and indoor units (ODU+IDU).

Method A: This controller calculates the power consumption of each unit.

Method B: Each unit calculates its own power consumption.

#### CAUTION

- Because the estimated kW calculated using either Method A or Method B is determined based on the unit's own estimates and calculations, it may differ from the real kWh by the unit. The result is not calculated based on the Measurement Act and cannot be used officially.
- The power consumed by air conditioners varies depending on the installation conditions, the set temperature, the outside ambient air temperature, and other operating conditions, even if the operating time is the same.
- Please note that we bear no responsibility for any damage or trouble due to this function's calculations, data loss, etc.
- There are rounding errors in the calculation results.
- This function calculates the approximate power consumed by air conditioners. Please note the above when you use it.
- When the system configuration or air conditioning unit is updated, the operation data collected from the unit and the collection method may change, which can affect the calculation results.
- This function correctly displays the amount of energy and the calculation results only when the air conditioner, system controller, and Energy Report Software 2 are operating normally.
- Before using this function, ensure there is no abnormality in the air conditioner.
- If this system is used for over 15 years, some data may not be saved.

## Restrict Operation of the Touch screen controller

You can restrict the operation range of the Unit by locking it.

This section explains how to set and release the lock.

For the restriction range, see "Set the operation lock level" (P.90).

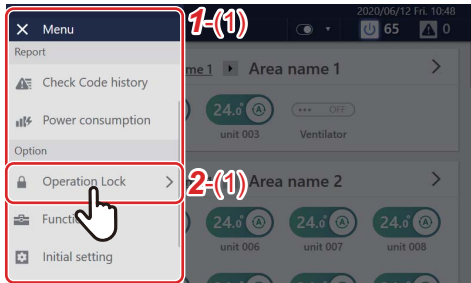

**1** Tap [1-(1)] appears.

**2** Tap [2-(1)]

Below, the screen for release is explained.

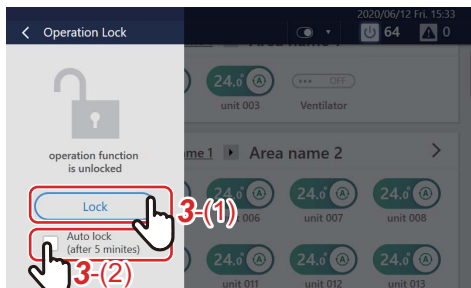

**3** Tap [3-(1)]  
To change the auto lock settings, tap [3-(2)]

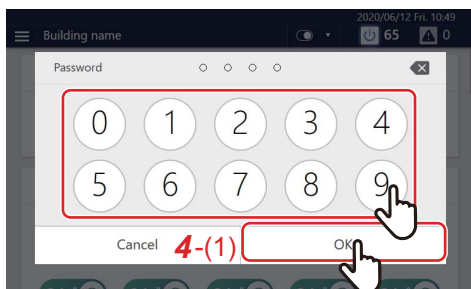

**4** Tap the number, enter the 4-digit password, then tap [4-(1)]

The lock is set or released.

### NOTE

- The initial set password is "1048".
- There are two levels of protection when locking. (P.90)
- Tap to delete one character.

### NOTE

- You can change the password. (P.90) If you do not know the password, please contact your administrator.
- If you enter the wrong password three times when unlocking, password input is restricted for 30 minutes.
- When automatic lock is set, the Unit will be locked automatically after 5 minutes have passed after an operation has completed.
- When the lock is set, if you tap a function that cannot be operated, the message "operation function is locked" is displayed. Also, appears in the menu.

## [Functions] Menu Settings

On the [Functions] menu, demand control of outdoor units and summation of data for power distribution can be performed.

### How to display the [Functions] menu



**1** Tap [1-(1)] appears.

**2** Tap [2-(1)] [3-(1)] appears.

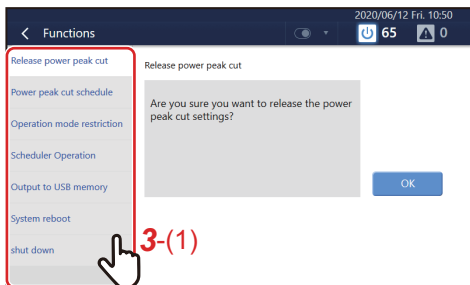

**3** Tap the item you want to set with [3-(1)]  
The settings screen of the selected item appears on the right.

For details on the setting contents of each item, refer to the following.

- Release power peak cut (P.80)
- Power peak cut schedule (P.81)
- Operation mode restriction (P.83)
- Scheduler Operation (P.83)
- Output to USB flash drive (P.84)
- System reboot (P.84)
- Shut down (P.84)

### Release demand control of outdoor unit

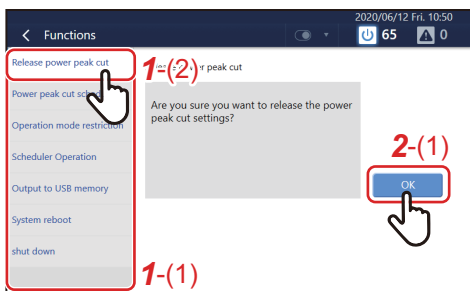

**1** Tap [1-(2)] with [1-(1)]

**2** Tap [2-(1)]  
Outdoor demand set for all outdoor units is released.

**NOTE**

- Outdoor demand can be set by the "Power peak cut schedule". (P.81)  
Outdoor demand may function with digital input set locally. In this case it can also be released.
- When you release the Power peak cut, the setting value of [Power peak cut] on the option screen changes to the release state. (P.59)



## Set demand control schedule of outdoor unit

The demand function of the outdoor unit can be managed with the schedule to 100% to 0% according to the peak time zone.

### Setting example:

If you set "80%" for 9:00 to 18:00,  
 "90%" for 18:00 to 21:00, and  
 "100% (No power peak cut)"  
 for 21:00 to 9:00 on next day

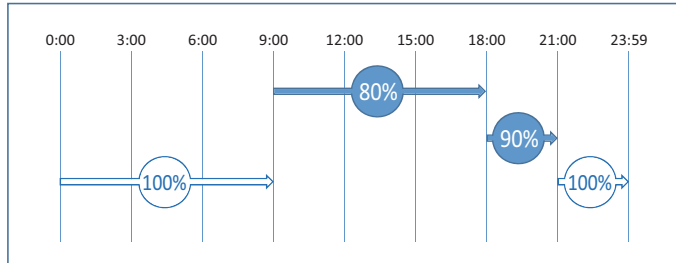

### NOTE

- Cannot be set when the Outdoor Demand Schedule is disabled. Please enable the Outdoor Demand Schedule. (P.83)
- Demand levels that can be set are "100% (No power peak cut)", "90%", "80%", "70%", "60%" and "0%".
- Up to 10 schedules can be created.

## Add/change power peak cut schedule

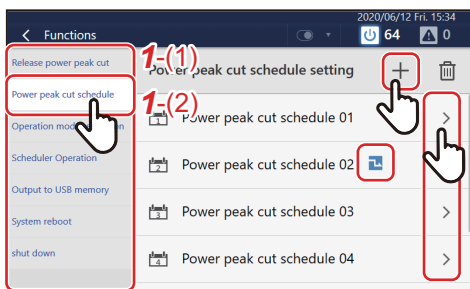

**1** Tap [1-(2)] with [1-(1)] (P.80)

**2** Tap + to register new  
 To change, tap > of the schedule you want to change

### NOTE

When the demand function is functioning at the current time,  appears.

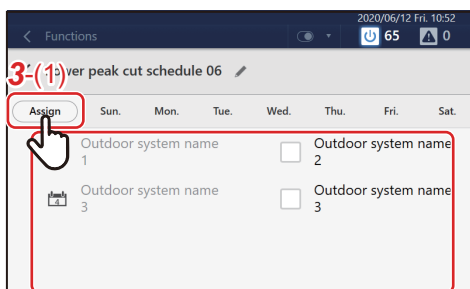

**3** Tap [3-(1)] and set the check box of the outdoor unit for setting the Power peak cut schedule to

### NOTE

The schedule number (  ) will be displayed on outdoor units that have already been scheduled. Cannot be selected.

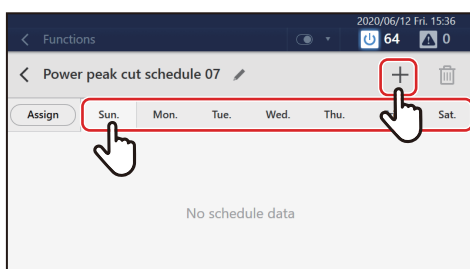

**4** Tap the day of the week tab to start the schedule, then tap +  
 To change an already registered schedule, tap > on the corresponding schedule

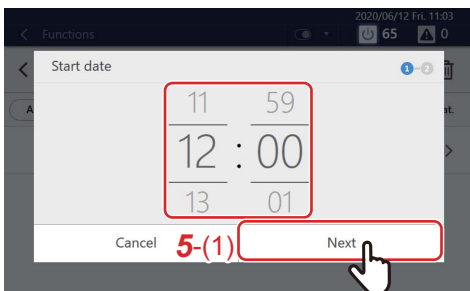

**5** Tap or flick to set the start time and tap [5-(1)]

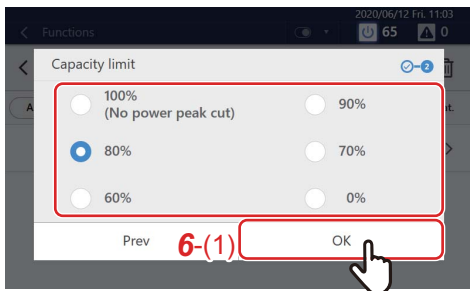

**6** Select the outdoor demand level and tap [6-(1)] to add a demand schedule

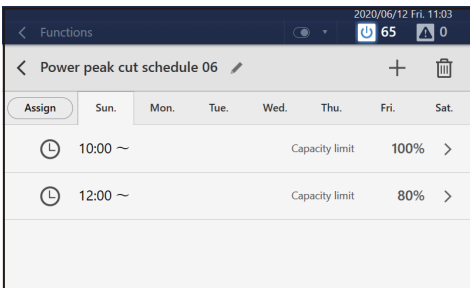

**7** To add a schedule such as change/release of demand level, repeat steps 4 to 6

**NOTE**

- The outdoor demand initiated by the schedule is released in the following cases.
  - When 100% (No power peak cut) is set in the schedule
  - When demand control of the outdoor unit has been released (P.80)
- Demand control continues even across days.
 

Example: When the demand rate is set to 0% on Monday at 21:00 and release is set at 9:00 on Tuesday

→ The demand rate is set to 0% from Monday at 21:00 to Tuesday at 9:00 and demand release occurs at 9:00 on Tuesday



## Delete a power peak cut schedule

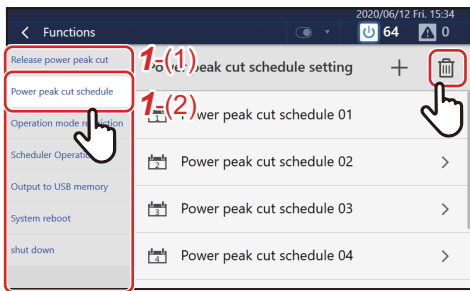

**1** Tap [1-(2)] with [1-(1)] (P.80)

**2** Tap

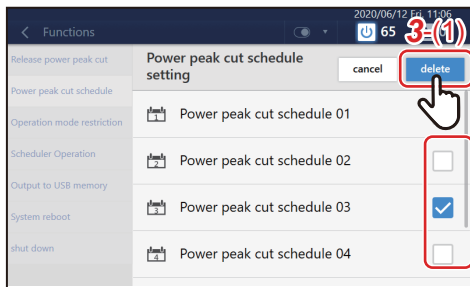

**3** Set the check box of the schedule you want to delete to , then tap [3-(1)]

The selected schedule will be deleted.

### NOTE

Also, when deleting a registered time, tap and operate similarly.

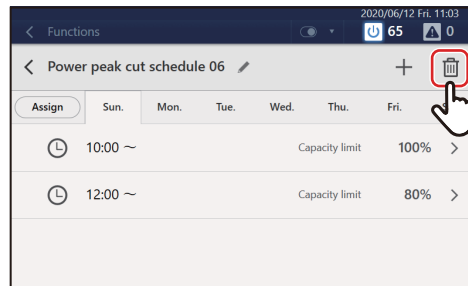

## Restrict operation mode

When using an outdoor unit that cannot operate cooling and heating at the same time, you can restrict its operation mode so that it can only be set for either cooling or heating.

**1** Tap [Operation mode restriction] in the [Functions] menu (P.80)

**2** Select the operation mode and tap [OK]

### NOTE

- Settings are reflected in all outdoor units.
- Even with restriction, the operation mode of the [CONTROL] tab can be selected. When a restricted operation mode is selected, the Thermo OFF state is set.

## Set the operating schedule or the power peak cut schedule

You can disable registered Operation Schedules and Power peak cut schedules so that they do not operate.

**1** Tap [Scheduler Operation] in the [Functions] menu (P.80)

**2** Set the check box to  if you do not want to operate each schedule, or set the check box to  to operate them, then tap [OK]

## Output data to a USB flash drive

You can output data for Energy Report Software 2 to a USB flash drive.

- 1** Connect the USB flash drive to the slot in the Unit
- 2** Tap [Output to USB flash drive] in the [Functions] menu (P.80)
- 3** Tap [OK]

### NOTE

If the USB flash drive is not connected, [OK] will not be enabled.

## Restart the unit

You can restart the Unit.  
The schedule is not executed during restart.

- 1** Tap [System reboot] in the [Functions] menu (P.80)
- 2** Tap [OK]

## Exit the system

Terminate the operation of the Unit.

### NOTE

This function turns off the power to the System Controller.  
It does not stop the air conditioners connected to the Unit.

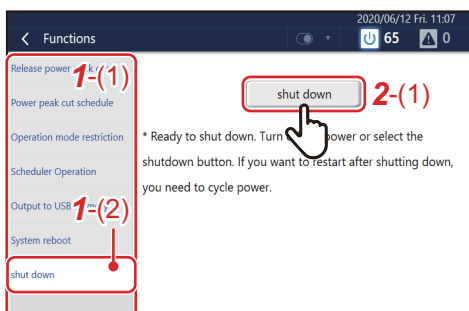

- 1** In [1-(1)], tap [1-(2)]
- 2** Tap [2-(1)]

## [Initial setting] Menu Settings

On the [Initial setting] menu, you can change the Unit screen display and the settings for remote operation, etc.

### How to display the [Initial setting] menu



**1** Tap .  
[1-(1)] appears.

**2** Scroll through the menu list and tap [2-(1)].  
[3-(1)] appears.

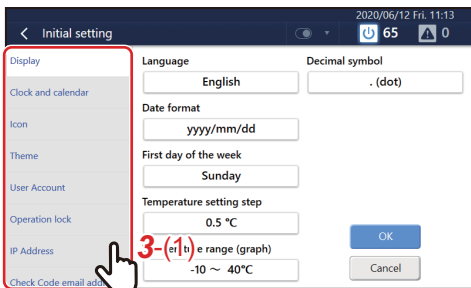

**3** Tap the item you want to set with [3-(1)].  
The settings screen of the selected item appears on the right.

For details on the setting contents of each item, refer to the following.

- Display (P.86)
- Clock and calendar (P.86)
- Icon (P.87)
- Theme (P.87)
- User Account (P.88)
- Operation lock (P.90)
- IP Address (P.91)
- Check code email address (P.92)
- Indoor unit area setting (P.93)
- Indoor unit name setting (P.95)
- Area name setting (P.95)
- Power peak cut due to external input (P.96)
- Backlight (P.97)
- Power peak cut (P.97)

## Set the screen display

You can change the display settings of the screen, such as language and date display format.

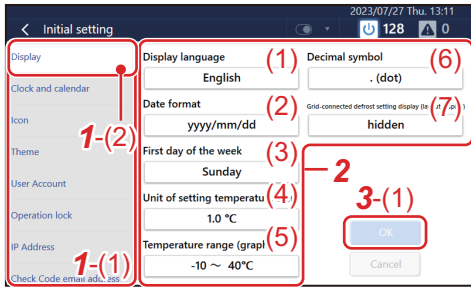

**1 Tap [1-(2)] with [1-(1)] (P.85)**

**2 Tap the item you want to change**

- (1) Language: You can change the display language of the screen.
- (2) Date format: You can change the format of the date displayed in the upper right of the screen.
- (3) First day of the week: You can change the first day of the week displayed on the calendar or schedule to Sunday or Monday.
- (4) Temperature setting step: You can change the temperature setting step to 0.5°C or 1°C. However, it cannot be changed if the display unit is Fahrenheit.
- (5) Temperature range (graph): You can change the temperature range displayed on the [GRAPH] tab.
- (6) Decimal symbol: You can change the decimal symbol displayed on the screen between [. (dot)] and [, (comma)].
- (7) System cooperation defrosting settings: You can change the display settings for information on the system cooperation defrosting settings.  
\* For details, contact service personnel.

**3 Select the value you want to change, then tap [3-(1)]**

## Set the current date and time

You can change the date and time displayed in the upper right of the screen.

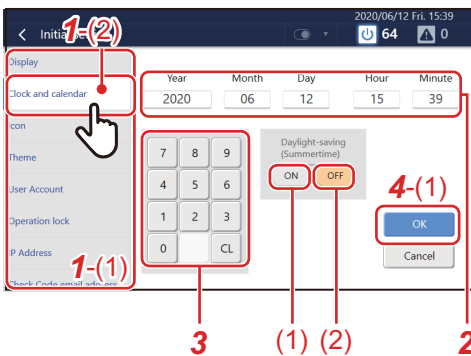

**1 Tap [1-(2)] with [1-(1)] (P.85)**

**2 Tap the item you want to change**

The characters of the selected item change to red.

**3 Tap the numeric keypad to enter a number**

**4 Tap [4-(1)]**

**NOTE**

You can set daylight saving time with [Daylight-saving (Summertime)]. When set to [(1)], the time moves one hour forward, and when set to [(2)], it moves one hour back. While daylight saving time is set,  appears in the upper right corner of the screen.

### Set icons of devices other than air conditioners

You can display icons of each device on the [CONTROL] tab of devices other than air conditioners such as ventilation fan or lighting.

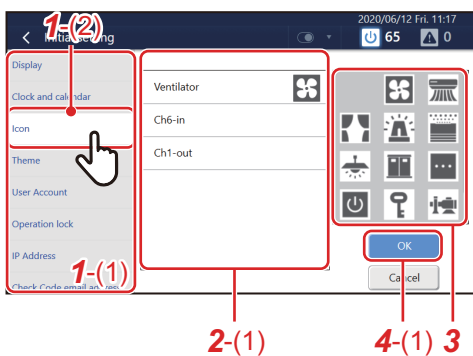
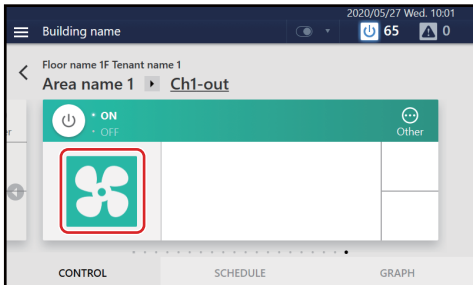

- 1** Tap [1-(2)] with [1-(1)] (P.85)
- 2** Tap the device you want to set with [2-(1)]
- 3** Tap the icon you want to set in the icon list  
The selected icon is displayed in [2-(1)].
- 4** Tap [4-(1)]

**NOTE**

- To delete a set icon, select the device with [2-(1)] and then tap the space at the top left of the icon list.
- The following icons can be set:

	Ventilation fan/Circulator		Room air conditioner		Curtain		Alarm		Humidifier/Dehumidifier		Lighting
	Cubicle		Water storage tank		General switch		Security		Pump		Camera

### Set the screen theme

You can set the theme of the home screen and the details/control screen.

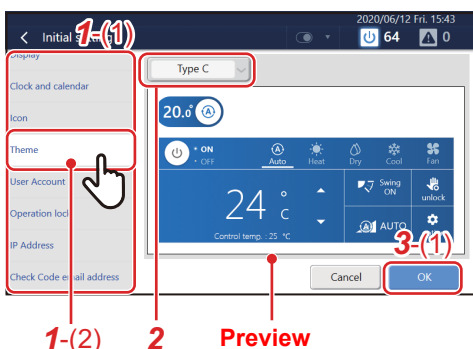

- 1** Tap [1-(2)] with [1-(1)] (P.85)
- 2** Tap the drop-down menu and select a theme  
The selected theme appears in the preview. Operate the switch or tap the power supply or operation mode button to check the display after the change.
- 3** Tap [3-(1)]

## Set an account for remote operation

You can set a user account to operate the Unit remotely.

\* Remote operation can be used when the Unit is connected via LAN to a PC on which the Remote Control Software is installed.

**NOTE**

- 128 users can be registered.
- Up to 16 users can log in at the same time.
- At least one user must be registered.

### Add/change user account

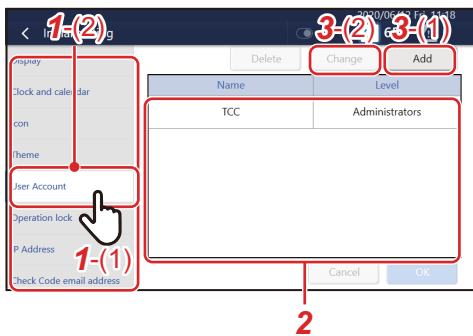

- 1 Tap [1-(2)] with [1-(1)] (P.85)
- 2 To change, tap the row you want to change in the list

**NOTE**

The following users are registered in advance. You can also change/delete users.

Name: TCC  
 Password: TCC  
 Level: Administrators

- 3 Tap [3-(1)] or [3-(2)]

In the following procedure, the screen in the case of addition is used to explain.

- 4 Set Name (only when adding) and password

Tap the entry field to display the keyboard. After entering the characters, tap [4-(1)].

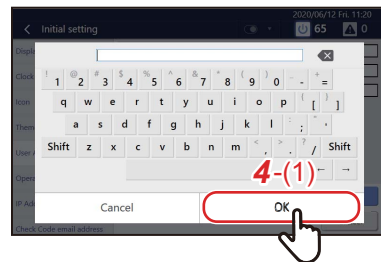
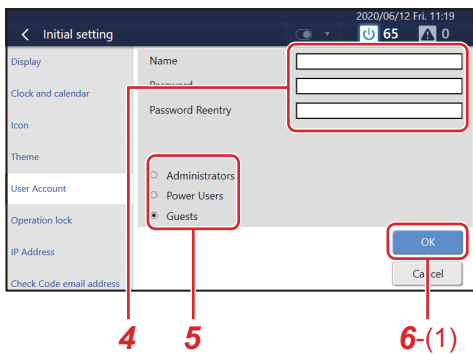

**NOTE**

- Tap [Shift] to toggle between upper case letters and lower case letters, and numbers and symbols.
- Tap to delete one character.



## 5 Set level

Administrators : All functions can be used.

Power Users : The following functions cannot be used.

- Confirm/change the operation schedule
- [Menu] > Functions
- [Menu] > Initial setting

Guests : Only the operation status can be confirmed. The settings cannot be changed.

**NOTE**

For details on the functions that can be used for each level, see "List by Lock Level/Level" (P.115).

## 6 Tap [6-(1)]

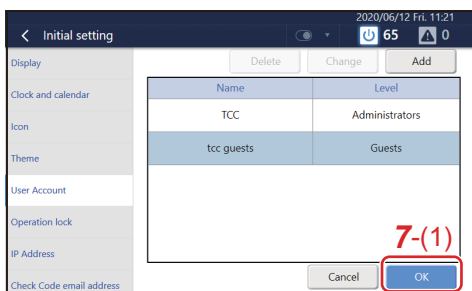

## 7 Tap [7-(1)]

### Delete a user account

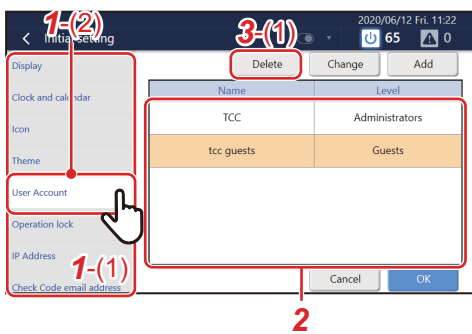

## 1 Tap [1-(2)] with [1-(1)] (P.85)

## 2 Tap the row you want to delete

## 3 Tap [3-(1)]

It will be deleted from the list.

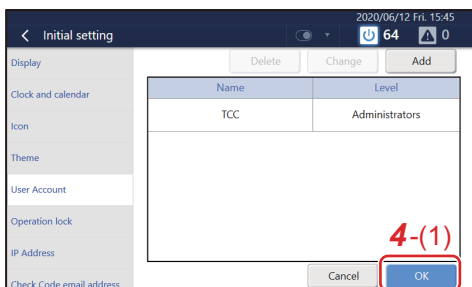

## 4 Tap [4-(1)]

Deletion is confirmed.

**Set the operation lock level**

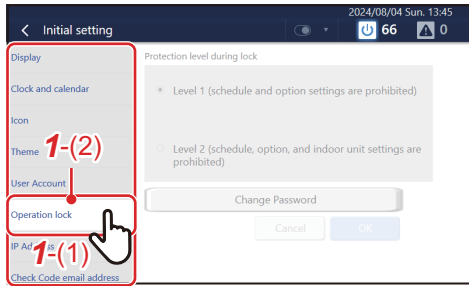

**1** Tap [1-(2)] with [1-(1)] (P.85)

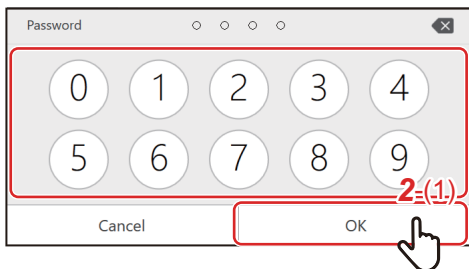

**2** Enter the password and tap [2-(1)]

**NOTE**

The factory default setting password is "1048".

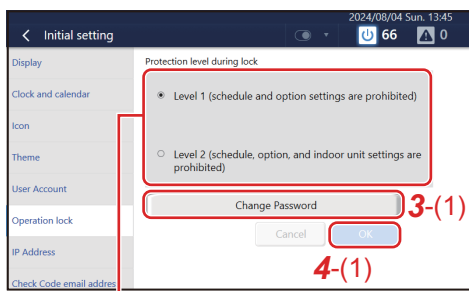

**3** Select the protection level during lock

**NOTE**

You can change the password that sets the operation lock. Tap [3-(1)] to display the change password input screen. Enter the changed password, tap [OK], re-enter it on the re-entry screen, then tap [OK]. 4-digit passwords can be set.

**4** Tap [4-(1)]



## Set check code email destination

You can set the email address to send email to when an error occurs.

### NOTE

Up to five email addresses can be set.

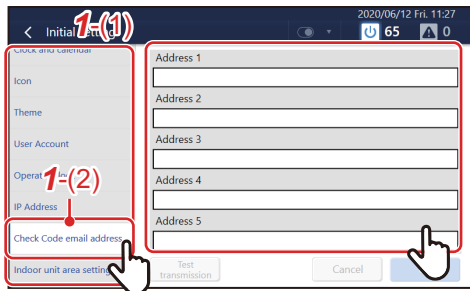

- 1** Tap [1-(2)] with [1-(1)] (P.85)
- 2** Tap the address field to register

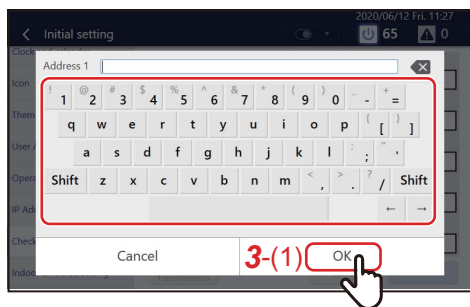

- 3** Enter the email address on the keyboard, then tap [3-(1)]

### NOTE

- Tap [Shift] to toggle between upper case letters and lower case letters, and numbers and symbols.
- Tap  to delete one character.

- 4** Tap [OK]

### NOTE

To test-send to the registered email address, tap [Test transmission], which displays after you tap [OK].

## Change the area set for an indoor unit

In [Indoor unit area setting], you can move the indoor unit A in area X to area Y.

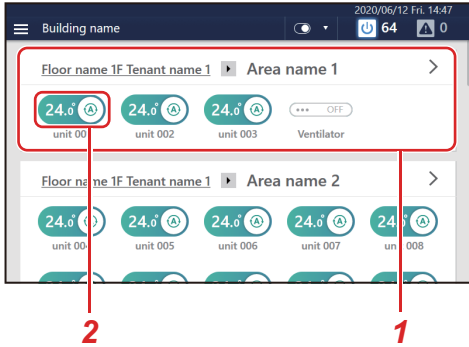

**NOTE**

- [1] All areas. The area numbers, such as area 1 and area 2, are allocated automatically in the upper section of the home screen.
- [2] Each indoor unit in the area.

The procedure below is used as an example to explain how to move the indoor unit (unit 001) set in area 1 to area 2.

**1** Tap [1-(2)] in [1-(1)] (P.85)

**2** Tap [2-(1)]



**3** Select [3-(1)] and tap [3-(2)]

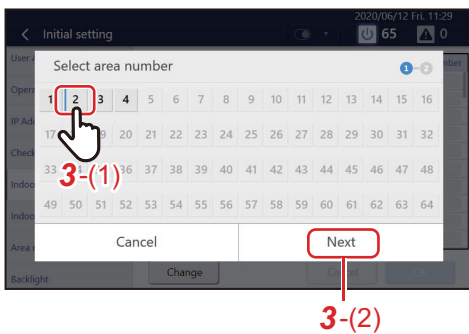

**4** Set the check box of the indoor unit (unit 001) you want to move to area 2 to  and tap [4-(1)]

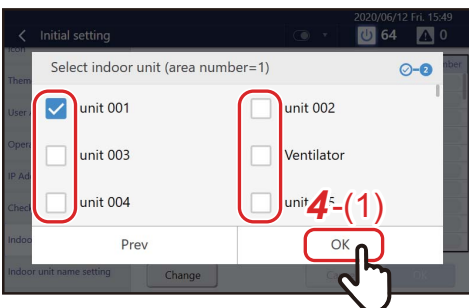

**5** Tap [5-(1)]

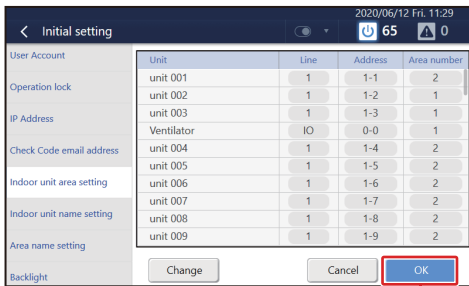

5-(1)

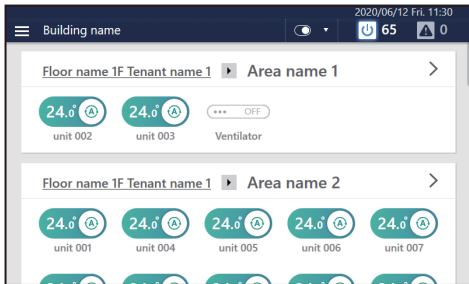

The indoor unit (unit 001) is moved to area 2.

**Set the name of an indoor unit**

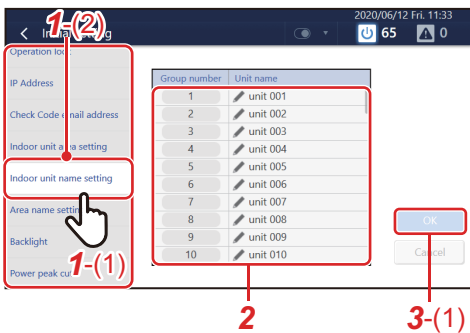

- 1 Tap [1-(2)] in [1-(1)] (P.85)
- 2 Tap the name you want to change in the list  
A keyboard is displayed. Enter the name and then tap [2-(1)].

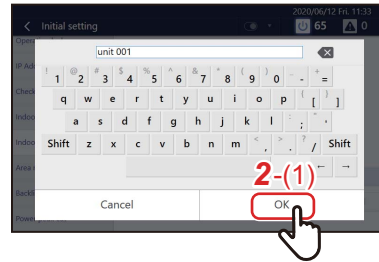

- **NOTE**
- Tap [Shift] to toggle between upper case letters and lower case letters, and numbers and symbols.
- Tap to delete one character.

- 3 Tap [3-(1)]

**Set the area name**

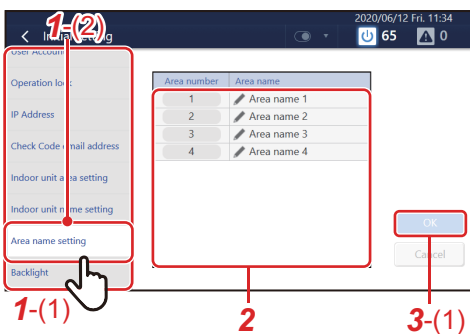

- 1 Tap [1-(2)] in [1-(1)] (P.85)
- 2 Tap the name you want to change in the list  
A keyboard is displayed. Enter the name and then tap [2-(1)].

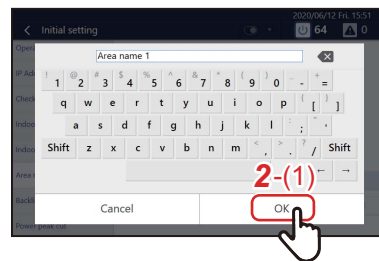

- **NOTE**
- Tap [Shift] to toggle between upper case letters and lower case letters, and numbers and symbols.
- Tap to delete one character.

- 3 Tap [3-(1)]

**Set the power peak cut for each outdoor or indoor unit**

You can set the power peak cut for each registered outdoor or indoor unit.

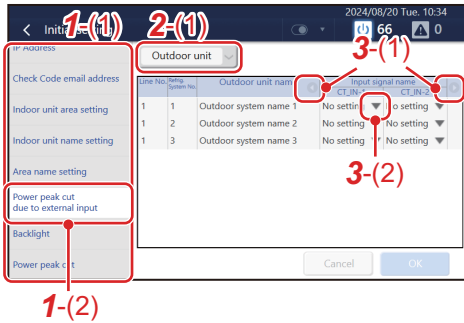

- 1** In [1-(1)], tap [1-(2)]
- 2** To set the power peak cut for indoor units, select the indoor unit from [2-(1)]
- 3** In [3-(1)], switch the channel to display and tap [3-(2)] for the unit you want to change the setting

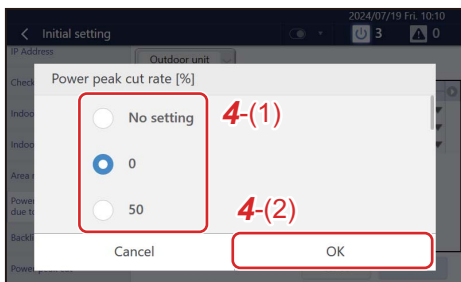

- 4** Select [4-(1)] and tap [4-(2)]

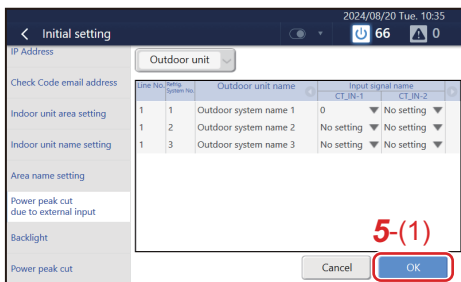

- 5** Tap [5-(1)]  
A pop-up screen appears.  
Check the message and tap [5-(2)].

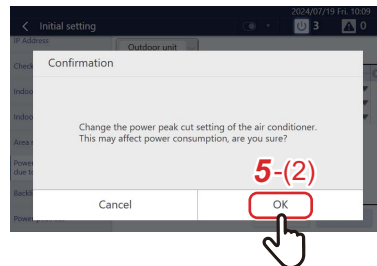

**NOTE**

The settings in this menu can be changed only at the time of trial operation.



## Set the screen brightness

You can set the brightness of the screen and the duration after the end of the operation. In (1, 3, 10, 30, 60, 360 (6 hours), 720 (12 hours) minutes)

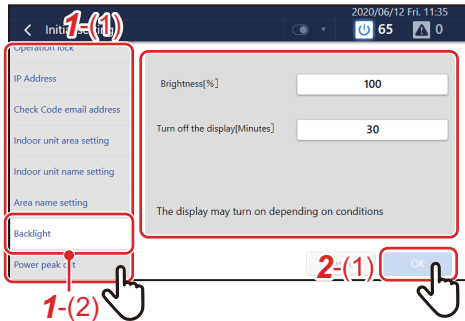

- 1 Tap [1-(2)] with [1-(1)] (P.85)
- 2 Select the brightness and tap [2-(1)]

## Set power consumption control conditions

You can set the conditions for controlling power consumption peaks.

Based on the pulse signal from the pulse transmission type watt hour meter, the power usage is calculated, and if it exceeds the power usage threshold, an operation control signal is sent to the outdoor unit.

There are two different settings:

- Energy threshold: Controls operation based on the pulse signal from the pulse transmission type watt hour meter.
- Peak cut signal reception: Controls operation based on the signal from the external demand device.

● **NOTE**

Before setting these items, initial settings are required. For details, contact service personnel.

### System diagram

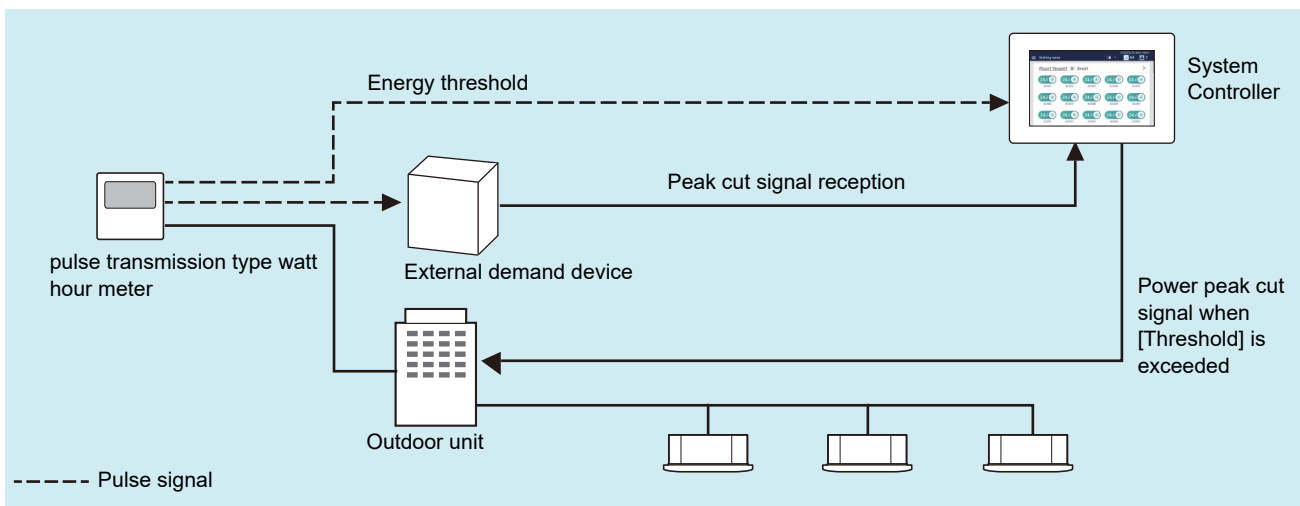

## Set Energy threshold

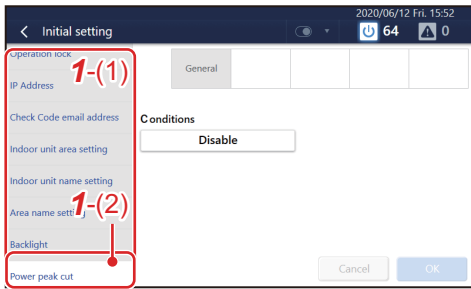

**1** In [1-(1)], tap [1-(2)]

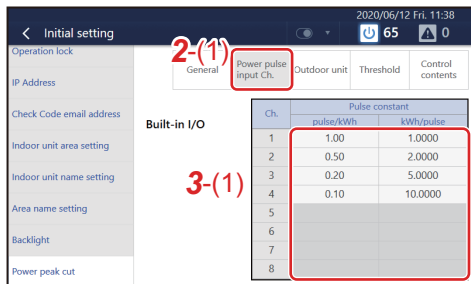

**2** Tap [2-(1)]

**3** Tap [3-(1)] and set the pulse constant for each of channels 1 to 8

**NOTE**

- Ensure that the pulse constant matches the output pulse of the pulse transmission type watt hour meter connected to the Unit.
- Channels 1 to 8 correspond to external input terminals DI1 to 8.
- Enter each pulse constant in either the [pulse/kWh] or [kWh/pulse] field. In the field in which no pulse constant is entered, the reciprocal of the entered value is displayed.
- Before setting these items, initial settings are required. For details, contact service personnel.

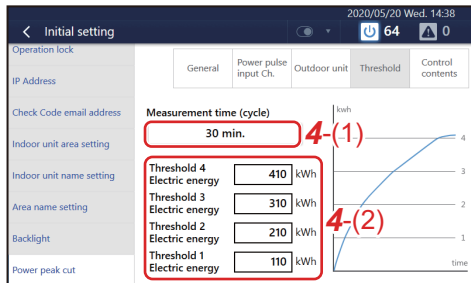

**4** Set data in [4-(1)] and [4-(2)]

**NOTE**

- In Measurement time, set the measurement time for power usage.
- For Threshold 1 to Threshold 4, set the power usage in the measurement time cycle.
- A threshold of 0 means that no threshold is set.
- Enter thresholds, starting with Threshold 1, in such a way that the threshold gets larger as the number increases. You cannot skip any number.
- If the actual power usage is 250 kWh, Threshold 1 (110 kWh) and Threshold 2 (210 kWh) are exceeded. Thus, power peak cut controls 1 and 2 are executed.

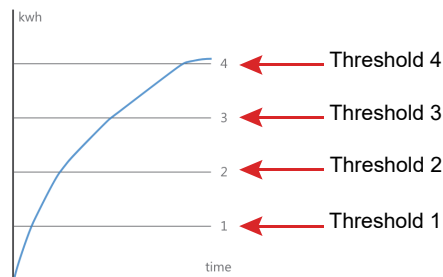

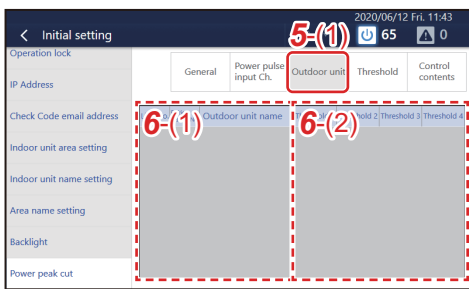

5 Tap [5-(1)]

6 Set the controls to execute if the thresholds that are set in step 4 are exceeded

- [6-(1)] Outdoor unit selection: Select a target outdoor unit
- [6-(2)] Control contents selection: Select the power peak cut control to execute if the threshold is exceeded

NOTE

- You can set power peak cut controls with seven stages from 100% (no restriction) to 0% (operation stop).
- You can set them for each of the outdoor units connected to the Unit.
- Before setting thresholds for outdoor units, initial settings are required. For details, contact service personnel.

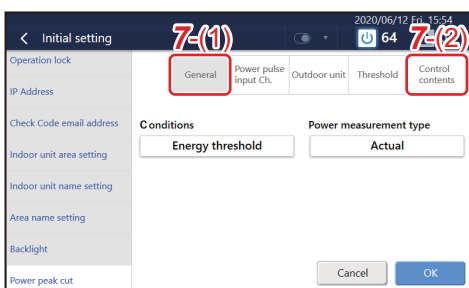

7 Tap [7-(1)] and tap [OK]

NOTE

Tap [7-(2)] to check the setting contents.

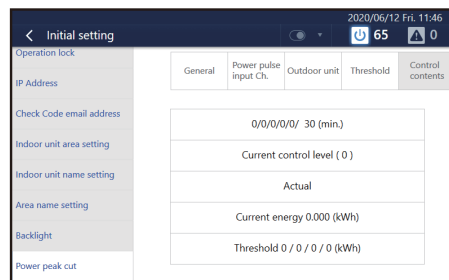

### Set Peak cut signal reception

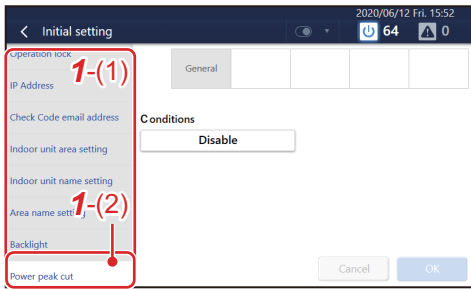

**1** In [1-(1)], tap [1-(2)]

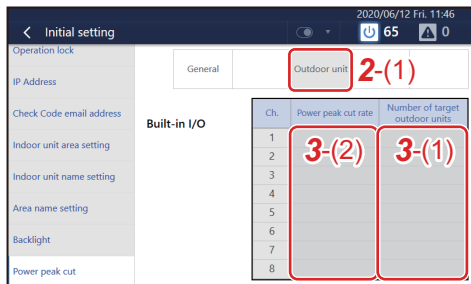

**2** Tap [2-(1)]

**3** Enter the power peak cut control to execute when the power peak cut signal is entered

- [3-(1)] Outdoor unit selection: Select a target outdoor unit
- [3-(2)] Control contents selection: Select the capacity limit to use when the power peak cut signal is entered

**NOTE**

- You can set them with seven stages from 100% (no restriction) to 0% (operation stop).
- You can set them for each of the outdoor units connected to the Unit.
- Before setting power peak cut controls, initial settings are required. For details, contact service personnel.

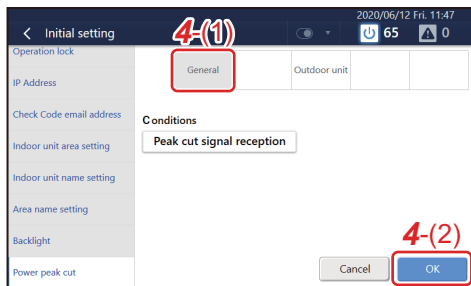

**4** Tap [4-(1)], and tap [4-(2)]

A popup screen appears.

Confirm the information, and then tap [4-(3)].

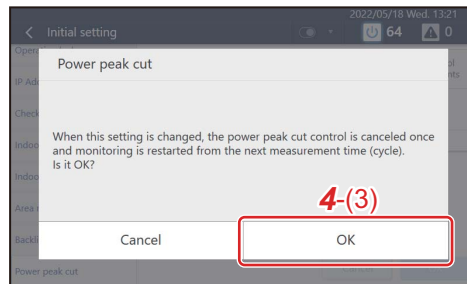

# 9 Remote Monitoring Using a PC

You can monitor and control the Unit by accessing it from a PC. This section explains the system diagram and the operating environment. For settings, etc., see "Settings for Remote Monitoring with a PC" (P.30).

## NOTE

Some functions cannot be used from a PC. For details, please see "List by Lock Level/Level" (P.115).

## Log in to Remote Control Software

## NOTE

Up to 16 users can log in at the same time.

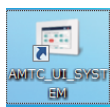

**1** Double-click "AMTC\_UI\_\*\*\*\*" on the desktop

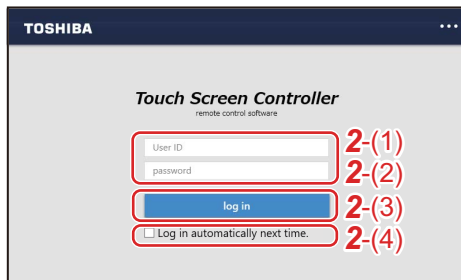

**2** Enter [2-(1)] [2-(2)], then click [2-(3)]

User ID/password:

Use the user account set up in step **1** of "Unit settings" (P.30).

If the [2-(4)] check box is selected, login will be automatic from the next startup onwards.

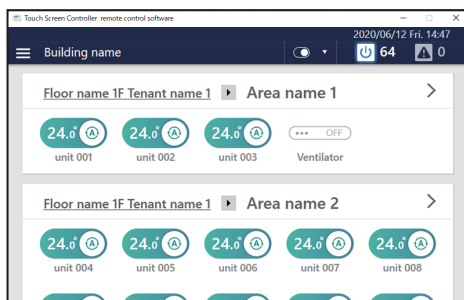

The home screen of the Remote Control Software is displayed.

## Log out from Remote Control Software

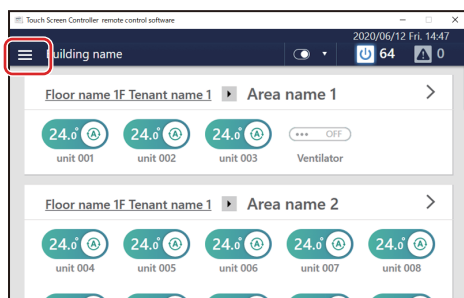

**1** Click 

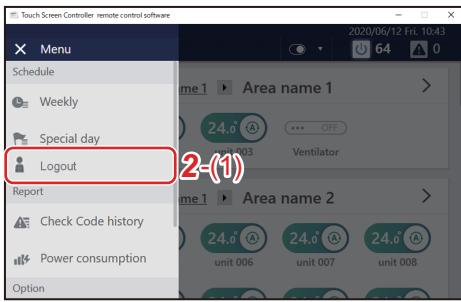

**2** Click [2-(1)]

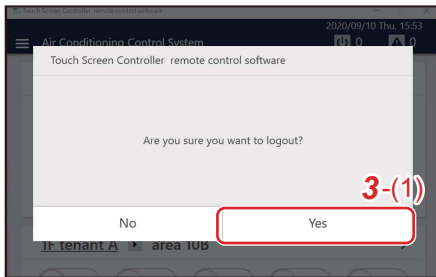

**3** Click [3-(1)]  
You are logged out from the Remote Control Software.

### Exit Remote Control Software

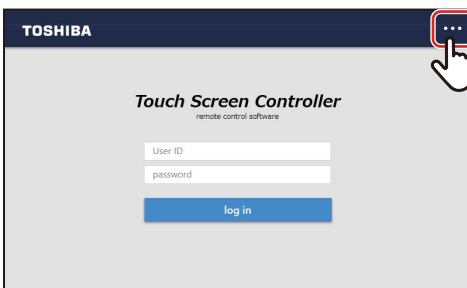

**1** Tap ...

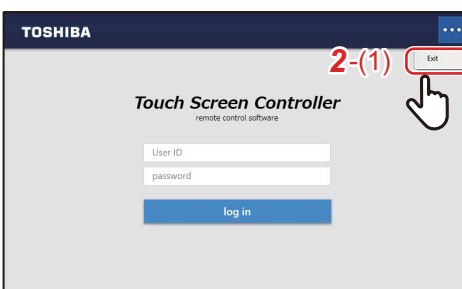

**2** Tap [2-(1)]

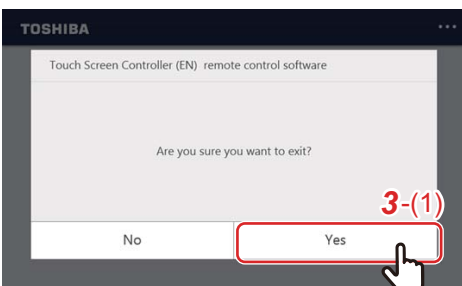

**3** Tap [3-(1)]  
Exit the Remote Control Software.

## Configure the login settings for multiple system controllers



**1** Double click [AMTC Launcher] on the desktop

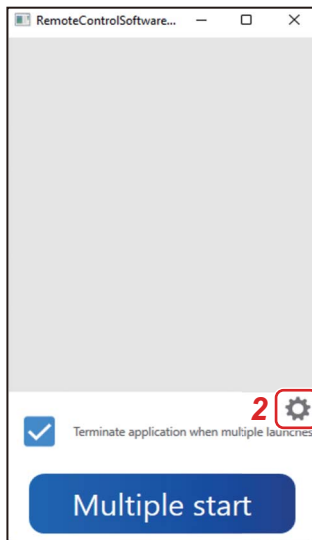

**2** Click [2]

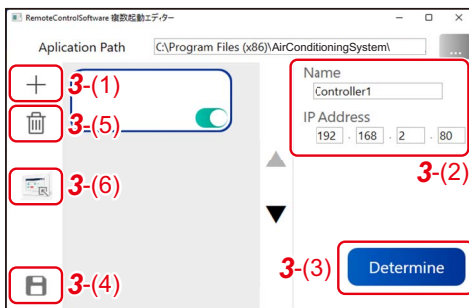

**3**  
**3.1** Click [3-(1)]

**3.2** Set the name of the system controller in [3-(2)] Name and the IP address of the system controller in IP Address, and click the [3-(3)]

\* To add multiple controllers, repeat Step **3.1** and **3.2** for each of the controllers.

**3.3** Click [3-(4)] to close the window

### NOTE

- Settings can be deleted by clicking the [3-(5)].
- A shortcut for the login settings can be created by clicking the [3-(6)].

**Log in to multiple system controllers**

**1** Double click [AMTC Launcher] on the desktop

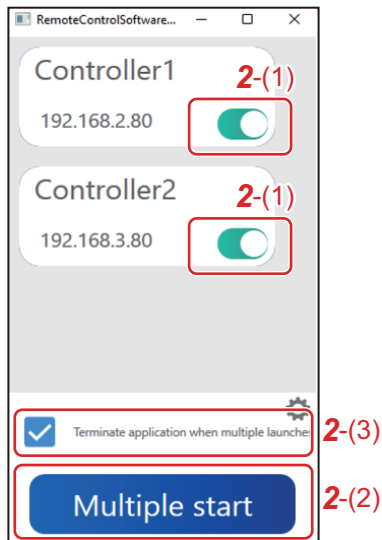

**2** Turn the [2-(1)] of the system controller you wish to log in to ON, then click the [2-(2)]

The home screens of multiple Remote Control Software are displayed.

\* If the [2-(3)] is selected, this window closes during startup.



# 10 Power Distribution

## Power Distribution System Using the Energy Report Software 2 (PC Software)

In normal houses, a contract is made with the electric power company for each house, but in buildings such as offices and shops, a contract is made between the building owner and the electric power company, and the building owner pays the total electricity bill. Therefore, in some cases the building owner distributes the electricity fee that they paid in bulk to each tenant and invoices for a fee.

With Energy Report Software 2, you can distribute the electric power based on data such as the operating time of the air conditioner(s) and the ON/OFF equipment recorded by the Unit. In addition, you can easily summarize the operation results in a report format and calculate the billing amount.

- \* There are two methods to calculate the estimated kW: Method A and Method B. Method B has two variations: one calculates the estimated kW only for the outdoor unit (ODU), and the other calculates it for both the outdoor and indoor units (ODU+IDU).  
 Method A: This controller calculates the power consumption of each unit.  
 Method B: Each unit calculates its own power consumption.

### Example report

Toshiba Building										
Air conditioner power distribution result Monthly report List										
Metering term										
Starting date Jan/01/2019										
Ending date Jan/31/2019										
Classification										
No.	System	Floor	Tenant	Area	Unit	Operating time[h]	Power [kWh]	Normal hours		
								Operating time[h]	Power [kWh]	Operating time[h]
1	ENR_test	Floor1	Tenant1	Area1	AC001	323.70	3,742.44	85.22	901.97	78.55
2	ENR_test	Floor1	Tenant1	Area1	AC002	331.55	3,582.63	83.13	893.77	79.85
3	ENR_test	Floor1	Tenant1	Area1	AC003	346.37	3,570.40	84.88	818.22	82.97
4	ENR_test	Floor2	Tenant2	Area2	AC004	339.97	3,670.81	83.42	886.18	84.68
5	ENR_test	Floor2	Tenant2	Area2	AC005	333.37	3,590.72	81.83	896.71	83.28
6	ENR_test	Floor3	Tenant3	Area3	AC006	331.55	3,582.63	83.13	893.77	79.85
7	ENR_test	Floor3	Tenant3	Area3	AC007	339.97	3,670.81	83.42	886.18	84.68
8	ENR_test	Floor3	Tenant3	Area3	AC008	333.37	3,590.72	81.83	896.71	83.28

### CAUTION

- This system calculates the distribution of the power by load ratio estimated for each air conditioner. The result may differ from the actual power consumed. In addition, the result is not calculated based on the Measurement Act and cannot be used officially.
- This system correctly calculates and displays the amount of energy and the apportionment result only when the air conditioner, this controller, and the PC software are operating normally.
- When using this system, make sure that no error has occurred in the air conditioner, etc.

### System diagram

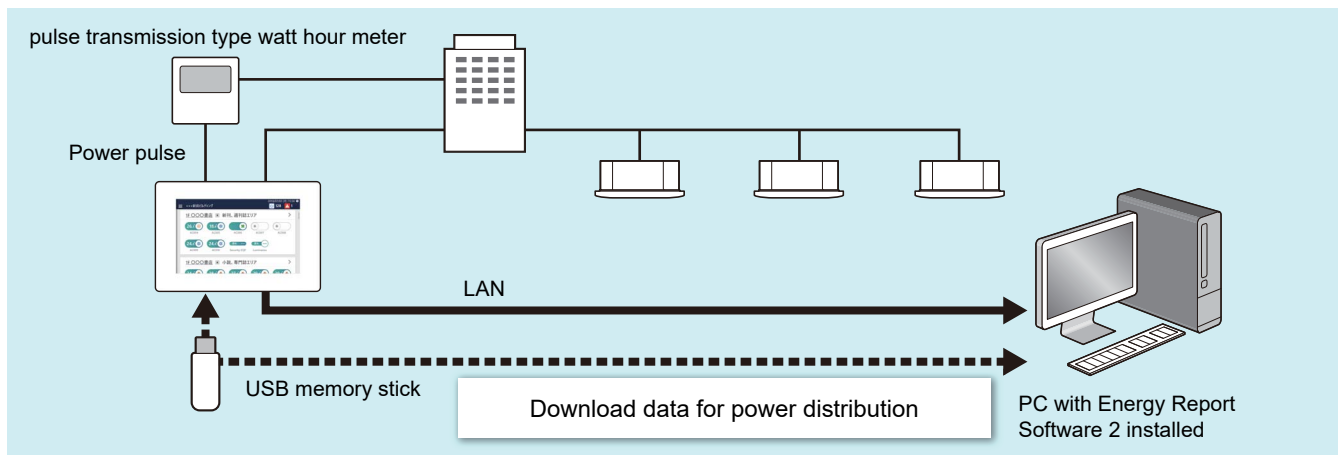

## How to use the power distribution system

### 1 Download the data for power distribution

Save the data for power distribution to the PC using one of the following procedures.

- 1) Download by LAN connection  
Download the data using the Energy Report Software 2.
- 2) Copy the data to a USB flash drive  
Output the data to the USB flash drive using the Unit's [Output to USB flash drive] and import the data using the Energy Report Software 2.

### 2 Create monthly reports and daily reports

Create a monthly report or daily report from [Change display] - [Report] in the Energy Report Software 2.

### 3 From the [Monthly report] screen or the [Daily report] screen, click the month or day you want to display

### 4 Click the [Output] button

#### • NOTE

For details, refer to the Operating Instructions of the Energy Report Software 2.

# 11 Troubleshooting

Phenomenon	Question	Confirmation items
The LCD does not display.	Is the power turned on?	Check that the power is not turned off by the breaker or the like. There is a green LED at the lower rear of the main unit and a green LED on the AC adapter that indicate that power is being supplied. Check that the wiring of the power outlet and AC adapter is not disconnected. There is a green LED at the lower rear of the main unit and a green LED on the AC adapter that indicate that power is being supplied.
	Has the backlight gone out?	The LCD turns off when there is no operation for a certain period of time. Touch the touch panel to turn on. The brightness and display time can be changed using [Backlight].
	Is the backlight brightness dark?	Adjust the brightness using [Backlight].
The operated air conditioner does not run.	Does the operated air conditioner match the actual air conditioner?	Operate another air conditioner and check if the actual air conditioner operates.
	Has a check code been detected?	The air conditioner will not operate when a check code has been detected. Erase the check code.
	Are you operating with the local remote control?	Even if the air conditioner is run with this Unit, if it is stopped afterwards with the local remote control, it will stop. The latter operation of this Unit or the local remote control overrides the former.
	Is the air conditioner stopped due to the schedule setting of the local remote control or the like?	Even if the air conditioner is run with this Unit, if it is stopped afterwards with the local remote control schedule, it will stop. The latter operation of this Unit or the local remote control overrides the former.
	Are you operating with the PC app "Remote Control Software"?	Even if the air conditioner is run with this Unit, if it is stopped afterwards with the PC app "Remote Control Software", it will stop. The latter operation of this Unit or the "Remote Control Software" overrides the former.
I want to turn off the power.	From [Menu], turn off the power.	Select [Menu]-[Functions]-[shut down].
I want to reboot.	Reboot from the menu.	Select [Menu]-[Functions]-[System reboot].
The air conditioner settings change arbitrarily.	Are you operating with the local remote control?	Even if the air conditioner is run with this Unit, if it is stopped afterwards with the local remote control, it will stop. The latter operation of this Unit or the local remote control overrides the former.
	Is the air conditioner stopped due to the schedule setting of the local remote control or the like?	Even if the air conditioner is run with this Unit, if it is stopped afterwards with the local remote control schedule, it will stop. The latter operation of this Unit or the local remote control overrides the former.
	Have you applied settings such as stop using an external input signal?	When stop, etc. is set by an external input signal using the external interlocking function, the air conditioner stops automatically when a signal is input.
	Are you operating with the PC app "Remote Control Software"?	Even if the air conditioner is run with this Unit, if it is stopped afterwards with the PC app "Remote Control Software", it will stop. The latter operation of this Unit or the "Remote Control Software" overrides the former.
The schedule does not work.	Is the schedule disabled?	Please confirm the Scheduler Operation settings.
	Does the scheduled air conditioner match the actual air conditioner?	Operate another air conditioner and check if the actual air conditioner operates.
	Is a Special day schedule set?	If a day is set in both the Weekly schedule and a Special day schedule, the Special day schedule will apply for that day.
The air conditioner doesn't cool. The air conditioner doesn't heat.	Is demand control turned on?	Demand control suppresses the capability of the outdoor unit in order to reduce power consumption. Therefore, it may take time to reach the set temperature.
	Is the forced thermo OFF control turned on?	Forced thermo OFF is a control to stop the operation of the outdoor unit. Therefore, the indoor unit acts as a fan.
	Is the power saving control turned on?	Power saving suppresses the capability of the outdoor unit. Therefore, it may take time to reach the set temperature.

Phenomenon	Question	Confirmation items
The LCD does not turn off.	Has a check code been detected?	The LCD will still be on when a check code has been detected. Erase the check code.
Sometimes the LCD becomes black for a moment.	The LCD's antistatic control is working.	Temporarily stop the LCD periodically to prevent LCD burn-in. Not a malfunction.
The setting displayed on the local remote control does not match the setting displayed on this Unit.	Does the operated air conditioner match the actual air conditioner?	Operate another air conditioner and check if the actual air conditioner operates.
I would like to frequently change detailed settings such as the set temperature and operation mode for all air conditioners.	Only "ON" and "OFF" can operate all air conditioners at once.	You can set the set temperature and operation mode, etc. for all air conditioners group by group. Please group the air conditioners.
When local remote control operation is prohibited, if there is a power failure, the local remote control prohibited status will be cancelled when the power returns.	-	Ask service personnel if you want to continue the local remote control prohibited status after returning from a power failure.
FILTER information can be reset even when the FILTER sign is not displayed.	The FILTER signs lights up depending on the accumulated operation time.	As the operation time accumulates, the FILTER sign lights up when the preset operation time is reached. The FILTER sign information can be reset to clear the accumulated time for cases such as when FILTER cleaning is carried out before the FILTER sign turns on.
I want to check the software version.	Reboot from the Information menu.	The version is displayed under [Menu] - [Information].
The webpage of the Controller is not displayed.	Is the power to the System Controller on?	If the power to the System Controller is not on, you cannot connect to the webpage. Confirm if the power is on.
	Is the LAN cable connected?	The webpage is not displayed unless the PC and the LAN of this Unit are connected. Check the LAN cable connection and network settings.
	Have you set the IP address?	You cannot connect to the Unit unless the IP address of the PC is set. For details, see P.31.
	Do you use a proxy server?	If the setting is such that a proxy server is used, exclude the IP address of the System Controller.
	Is the setup script set to ON?	If "Use Setup Script" is set to ON on your PC, change it to OFF. (It may work normally even if it is ON)
Reboot from time to time.	Please check for noise and the power supply status.	The main unit may restart if noise in the surroundings or an unstable power supply cause the operation of the software to be unstable. Please check the surrounding environment.
I cannot start the Remote Control Software.	Is "Error 1001" displayed?	Please download .Net Framework 4.8 from the download website of this software and install it.
	Is the LAN cable connected?	This software will not start unless the PC and the LAN of this Unit are connected. Check the LAN cable connection and network settings.
	Is the IP address of the access destination set to the IP address of the controller main unit?	The IP address (or server name) to be entered during installation is the IP address of the controller main unit. It is not the IP address of the PC. If it is incorrect, please do the following and then reinstall. 1. Uninstall the application 2. Delete the install destination directory 3. Delete the desktop and start menu shortcuts
	Is the operating system of your computer Windows 10 or Windows 11?	The supported operating systems are Windows 10 and Windows 11. The software may not operate correctly when installed on a PC with a different OS.

Phenomenon	Question	Confirmation items
I cannot log in to the Remote Control Software.	Have you logged in as the same user from another PC?	Each user can log in from only one PC at the same time.
	Is the Windows display style set to classic style?	Please select a display style other than classic style. You can change the display style from [Start] - [Control Panel] - [Appearance and Personalization] - [Change the theme]. The supported operating systems of this software are Windows 10 and Windows 11.
I cannot log in to Remote Control Software from another PC after the LAN is disconnected.	Have you logged in with the same user ID?	You must log in again from a PC with the LAN disconnected and log out normally.
	Have you accessed the software from more than 8 PCs?	Up to 8 PCs can be accessed at the same time. The software may not operate correctly if you connect to more than 9 PCs.
	Did you assign the PC's IP address using a DHCP server?	This Unit judges whether it is accessed from the same PC using the IP address. If the PC address is changed partway through by the DHCP server, you may not be able to log in again after LAN disconnection. Please set the PC that accesses this Unit to a fixed IP or reboot the Unit and erase the login information.
The language does not switch with the Remote Control Software.	Does the login user for the Windows being used have write permission for the Remote Control Software storage location?	Please allow write permission below the folder where Remote Control Software is saved (initial setting: C:\Program Files\AirConditioningSystem). Right-click on the AirConditioningSystem folder, select the [Properties] - [Security] Name, click the "Edit" button and check [Allow] for [Full control] under different settings.
The schedule setting changes have not been reflected.	Are you trying to change the schedule settings on both the Remote Control Software and the main unit?	To change the schedule settings, please set only one of either the main unit or the Remote Control Software.
I would like to use the software with other centralized controllers.	Centralized controllers that can be used together within the same network.	It is possible to use up to 8 units together with all centralized controllers including this Unit. Ask service personnel to use them in combination.
I want to use multiple units in combination.	Number of units that can be used in combination in the same network.	It is possible to use up to 8 units together with all centralized controllers including this Unit. Ask service personnel to use them in combination.
The LCD sometimes turns black for a moment.	The LCD's antistatic control is working.	This is not a malfunction. The LCD may turn black temporarily to remove static electricity.
The multi outdoor unit's option board control does not work.	Do you want to use the multi outdoor unit's option board?	When the centralized controller is connected, the functions of the outdoor unit's option board become ineffective. Only one of the centralized controller and the outdoor unit's option board can be used.
The Unit does turn ON/OFF even though the operation interlock signal/stop interlock signal is input.	Has the interlock signal been input from the time of activation?	Since the interlock signal confirms the state by detecting the rising edge and falling edge, if the interlock signal is input from the time of activation, interlock control will not be performed. Please set so that the interlock signal turns OFF at the time of activation.
When the external device is repeatedly ON/OFF, the ON/OFF are repeated for a while after the operation is stopped.	Do you control and monitor external devices by connecting a digital input / output interface?	To control the ON/OFF with an external device, wait at least 15 seconds for the next operation after one operation. Alternatively, change the setting to control and monitor using the DI / DO of the controller instead of the digital I / O interface connection.
	Do you have alarm monitoring settings for External Units?	If the alarm monitoring of External Unit is not set, the alarm cannot be detected.
S33 (central controller addresses duplicated) has occurred.	Are LINK1 (Uh) and LINK2 (Uh) connected to the same wires?	LINK1 (Uh) and LINK2 (Uh) cannot be connected to the same wires.
	Is the Central Controller ID the same as another Central Control Device that is connected to the same LINK?	Change them so that the Central Controller IDs (addresses) of the Central Control Devices, not just the Touch screen controllers, connected to the same LINK, are not the same.

Phenomenon	Question	Confirmation items
Even though it is communicating with the indoor unit, C06, S01, or S20 (communication error) is generated.	Are this unit's address settings and the indoor unit's address settings correct?	Double-check that this unit's address settings match the indoor unit's address settings.
Even though it is communicating with the indoor unit, ControlTemp is displayed at -35°C or -31°F.	Is the indoor unit for this unit incorrectly registered as an "outdoor air handling unit"?	Make sure that the registered information is correct for the actual indoor unit.
The check code S19 (BMS-IFDD initialization communication incomplete) is generated.	Check the TCC-LINK wiring and terminator resistors.	Due to a communication error with the digital input/output relay interface (BMS-IFDD initialization communication incomplete), the TCC-LINK communication between the digital input/output relay interface and this unit has not been working from the initial state. Check the TCC-LINK wiring and terminator resistors.

# 12 Useful Information

The following cases are not faults with the Unit.

Problem	Cause
When an air conditioner is stopped, its operation status is displayed on the LCD display part of the Touch screen controller.	This is because even when an air conditioner is stopped, you can set its operation from the Touch screen controller.
The display does not switch even if you operate the Touch screen controller.	<ul style="list-style-type: none"> <li>• The function is not provided by the air conditioner.</li> <li>• There may be an error in the operation method. Please check the operation explanation of the function.</li> <li>• This is because switching of HEAT and COOL in the operation mode is prohibited.</li> </ul>
It is not set even when operating the Touch screen controller.	

Please check the following before requesting service.

Problem	Cause	Solution
The air conditioner does not operate even when I press the Run/Stop switch on the Touch screen controller.	Has a power outage occurred?	If the LCD of the Touch screen controller does not display, press the ON/OFF button of the Touch screen controller again after energizing the controller.
On the LCD display part of the Touch screen controller  (Abnormality) and the check code S01 is displayed.		After restoring power to the air conditioner, the display will disappear after waiting a few minutes.
The check lamp of the Touch screen controller lights up.	Is the air conditioner protection device operating?	Please see the air conditioner owner's manual and check the operation.

If you have investigated the above and there is still an abnormality, please contact the dealer from whom you purchased the Unit with the part number and problem.

Under no circumstances conduct repairs by yourself. Doing so is dangerous.

Moreover, if the LCD display part of the Touch screen controller displays  (Abnormality) and a check code, please also inform the dealer of these items.

# 13 Appendix

## Specifications

### Detailed specifications

<b>Power supply</b>	220-240 V AC 50/60 Hz
<b>Consumed current</b>	1.17 A
<b>Operating temperature/ humidity range</b>	0°C to 40°C, 10% to 90% RH (no dew condensation)
<b>Dimensions (mm)</b>	H136×W205×D10(+80) (Embedded dimensions shown in parenthesis)
<b>Mass</b>	1.34 kg (Touch screen controller) 0.45 kg (power adapter)
<b>LCD</b>	Type 7 TFT liquid crystal, 800×480, 167,000 colours
<b>Touch Screen</b>	Projection-capacitive type
<b>Communication ports</b>	· RS-485 port ×1 (for connecting four digital I/O interfaces and four watt hour meter interfaces) · LAN port ×1 (for connecting PC)
<b>USB port</b>	USB flash drive connection port ×2
<b>External contact input</b>	8 inputs
<b>External contact output</b>	4 inputs
<b>Included PC software (*1) (Requires a separate PC (*3))</b>	· Remote Control Software · Energy Report Software 2 · Section Configuration Software

\*1 You can download the owner's manual and installer for "Section Configuration Software" from inside the controller. After setting the IP address of the computer (P.31), use the customer's web browser to access the following URL.  
<http://192.168.2.80/touchscreencontroller/EN/download.html> \*2

\*2 Input the value set in "Set the IP address of the Touch screen controller" (P.91) in place of "192.168.2.80".

\*3 Conditions for PC connection (operating environment)  
OS: Windows 10, Windows 11  
LAN port: 10BASE-T or 100BASE-TX wired LAN port  
Other: mouse/keyboard, printer (if printing is required)



**Function list**

Key Features		
<b>Control</b>	ON/OFF	
	Mode	
	Set temp.	
	Fan speed	
	Wind direction (up / down)	
	Lock setting of remote control	
	Wind direction (left / right)	
	Ventilation → ON/OFF	
	Ventilation → Mode	
	Ventilation → Fan speed	
	Night operation	
	Filter sign reset	
	Soft Cooling	
	Energy saving ratio [%]	
	Saving operation	
	Forced Thermo OFF	
	Return Back	
	Eco Temperature Shift	
	Set temp. range limit	
	<b>Monitoring</b>	ON/OFF
		Mode
Set temp.		
Fan speed		
Wind direction (up / down)		
Lock setting of remote control		
Wind direction (left / right)		
Ventilation → ON/OFF		
Ventilation → Mode		
Ventilation → Fan speed		
Soft Cooling		
Energy saving ratio [%]		
Eco Temperature Shift		
Set temp. range limit		
Outdoor temp.		
Power Level		
Return Back		
Power peak cut		
Filter Sign		
<b>Schedule</b>	Setting unit (Per unit)	
	Setting unit: Weekly schedule (per day of the week)	
	Setting unit: Special day schedule (per date)	
	Setting time (00:00 to 23:59)	
	Setting content	ON/OFF
		Mode
		Set temp.
		Local remote controller operation lock/unlock
		Return Back
		Night operation
		Energy saving ratio [%]
Ventilation operation		
Vent. Mode		
Maximum number of schedules per day 64		

Key Features			
<b>External input</b>	Inputs	Main unit	8 inputs
		DIO interface	8 inputs x 4 units
	Functions	Power pulse measurement	
		Demand Interlocking	
		Fire Alarm Interlocking	
		Locking Interlocking	
		Stop Interlocking	
		Operation Interlocking	
		For external device ON/OFF indication	
		For external device check code display	
<b>External output</b>	Outputs	Main unit	4 outputs
		DIO interface	4 outputs x 4 units
	Functions	Air conditioner check code output	
		Operation output	
		System Controller check code output	
		Operation output to external device	

Check Code	Check Code Names
S01	Communication error between air conditioner and BMS
S02	BMS-IFLSV Communication error
S03	Group terminal unit error
S04	BMS-IFWH Communication error
S06	BMS-IFWH Communication error
S07	BMS-IFDD Communication error
S08	Communication error
S09	Communication error
S12	Other error
S14	Start failure
S15	File access error
S16	IP address setup error
S17	File load error
S18	BMS-IFWH initialization communication incomplete
S19	BMS-IFDD initialization communication incomplete
S20	Initialization between air conditioner and BMS is not completed
S21	Mail transmission error
S22	Internal communication error
S23	Setting file read error
S25	Schedule file read error
S26	Schedule file write error
S27	Daily report/Monthly report file read error
S28	Daily report/Monthly report file write error
S29	Application error
S30	System error
S32	Alarm activation
S33	System controller address duplication error
S36	CO <sub>2</sub> concentration threshold exceeded

For check codes other than those listed above, refer to the respective manuals of each connected model.

## List by Lock Level/Level

Refer to the following table for the functional differences depending on the operation of the main Unit and remote operation, the level of the operation lock of the main Unit and the level of the user account.

(○: Full functional operation △: Partially restricted –: Cannot be used)

Item		Unit Operation			Remote Operation		
		Operation Lock None	Operation Lock - Level 1	Operation Lock - Level 2	Administrators	Power Users	Guests
Home screen		○	○	△	○	○	△
List screen		○	○	△	○	○	△
Layout screen		○	○	△	○	○	△
Batch ON/OFF screen		○	○	△	○	○	△
Check Code screen		○	○	△	○	○	△
Group screen	[CONTROL] tab	○	–	–	○	○	–
	[SCHEDULE] tab	○	–	–	○	–	–
	[GRAPH] tab	○	○	–	○	○	–
Individual control screen	[CONTROL] tab	○	○	–	○	○	–
	[SCHEDULE] tab	○	–	–	○	–	–
	[GRAPH] tab	○	○	–	○	○	–

Item			Unit Operation			Remote Operation			
			Operation Lock None	Operation Lock - Level 1	Operation Lock - Level 2	Administrators	Power Users	Guests	
Menu	Schedule	[Weekly] tab	○	–	–	○	–	–	
		[Special day] tab	○	–	–	○	–	–	
	Report	Check Code history	○	○	○	○	○	○	
		Energy Monitor	○	○	○	○	○	○	
	Option	Operation Lock		○	○	○	○	○	○
		Functions	Release power peak cut	○	–	–	○	–	–
			Power peak cut schedule	○	–	–	○	–	–
			Operation mode restriction	○	–	–	○	–	–
			Scheduler Operation	○	–	–	○	–	–
			Output to USB flash drive	○	–	–	–	–	–
			System reboot	○	–	–	○	–	–
			Shut down	○	–	–	○	–	–
		Initial setting	Display	○	–	–	○	–	–
			Clock and calendar	○	–	–	○	–	–
			Icon	○	–	–	○	–	–
			Theme	○	–	–	○	–	–
			User Account	○	–	–	–	–	–
			Operation Lock	○	–	–	○	–	–
			IP Address	○	–	–	–	–	–
			Check Code email address	○	–	–	–	–	–
			Indoor unit area setting	○	–	–	–	–	–
			Indoor unit name setting	○	–	–	–	–	–
			Power peak cut due to external input	○	–	–	–	–	–
			Area name setting	○	–	–	–	–	–
			Backlight	○	–	–	–	–	–
		Power peak cut	○	–	–	–	–	–	
		User's manual		○	○	○	–	–	–
		Open source software license		○	○	○	○	○	○
		Information screen		○	○	○	○	○	○
		Logout		–	–	–	○	○	○

## List of items listed in CSV file

### AVG\_(Hour,Day,Month)\_IDU\_ECalc\_(yyyymm,yyyy,ALL).csv

Item	Unit	Description
DateTime	-	Date
LinkNo	-	TCC-LINK No. 1/2
LineAddress	-	System number 1 - 32
IndoorAddress	-	Indoor unit address 1 - 128
OperationMode	-	Operation mode 0 (cool or auto (cool)) / 1 (heat or auto (heat)) / 2 (dry) / 3 (fan) / 4 (other)
SetTemperature	°C	Average of set temperature (°C) = data value × (0.5 - 35)
ControlTemperature	°C	Average of control temperature (°C) = data value × (0.5 - 35)
OutdoorTemperature	°C	Average of outdoor temperature (°C) = data value × (0.5 - 35)

### AVG\_(Hour,Day,Month)\_ODU\_ECalc\_(yyyymm,yyyy,ALL).csv

Item	Unit	Description
DateTime	-	Date
LinkNo	-	TCC-LINK No. 1/2
LineAddress	-	System number 1 - 32
ODUEERandCOP	-	Average efficiency value of outdoor unit
SystemEERandCOP	-	Average value of efficiency value of outdoor unit and indoor unit combined
ODUEstimatedConsumptionW	Ewh	Cumulative value of power consumption estimated by the outdoor unit
SystemEstimatedConsumptionW	Ewh	Cumulative value of power consumption estimated by outdoor and indoor units
Capacity	w	Average ability score

### AVG\_(Hour,Day,Month)\_WHM\_ECalc\_(yyyymm,yyyy,ALL).csv

Item	Unit	Description
DateTime	-	Date
DeviceID	-	Input Device ID 1 (System Controller) / 111 (Energy Monitoring Relay Interface_1) - 125 (Energy Monitoring Relay Interface_15)
ChannelNo	-	Input Channels 1 - 8

\* Items other than those listed will be private.

# 14 Warranty and After-Sales Service

## About the Warranty

- The warranty period is one year from date of purchase.

## About After-Sales Service

- Please check "11. Troubleshooting" (P.107) before requesting a repair. If this does not solve the problem, immediately shut off the power supply and contact us.
- Please inform us of the following when requesting a repair.
  - **Customer name**
  - **Address, phone number**
  - **Product model name and serial number**
  - **Installation date**
  - **Failure status (as much detail as possible)**

## Contact for after-sales service

For after-sales service, please contact here.

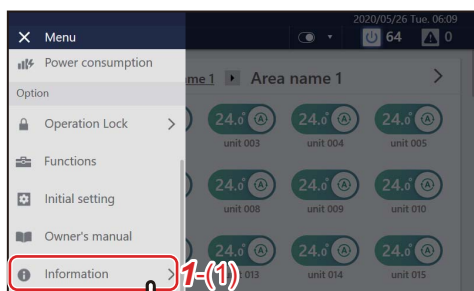

- 1 Tap , then tap [1-(1)]  
The contact information is displayed.

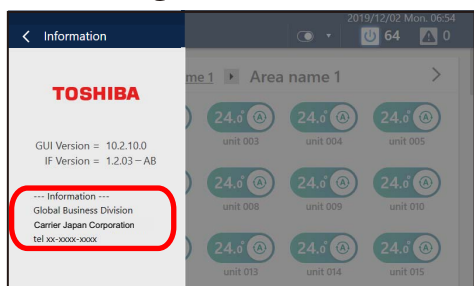

### Customer Memo

Model Name	BMS-CT2560U-E / BMS-CT2560U-TR		
Installation Date	Year	Month	Day
Name of dealer from whom you purchased the unit	Phone number		

It is convenient to fill this in at the time of purchase in case you need to request repair, etc.

# Carrier Japan Corporation

336 TADEHARA, FUJI-SHI, SHIZUOKA-KEN 416-8521 JAPAN

DEB5869001-7