

 **IntesisBox**<sup>®</sup>  
TO-AC-KNX v2.0

User's Manual

Issue Date: 03/2014  
r1.1 eng

**Intesis** 

## © Intesis Software S.L. 2014 All Rights Reserved.

Information in this document is subject to change without notice. The software described in this document is furnished under a license agreement or nondisclosure agreement. The software may be used only in accordance with the terms of those agreements. No part of this publication may be reproduced, stored in a retrieval system or transmitted in any form or any means electronic or mechanical, including photocopying and recording for any purpose other than the purchaser's personal use without the written permission of Intesis Software S.L.

Intesis Software S.L.  
Milà I Fontanals, 1 bis  
08700 Igualada  
Spain

### TRADEMARKS

All trademarks and trade names used in this document are acknowledged to be the copyright of their respective holders.

Gateway for integration of Toshiba's air conditioners into KNX TP-1 (EIB) control systems. Compatible with air conditioners connected through the TCC link from Toshiba.

Application's Program Version: 2.0

**Order codes:****TO-AC-KNX-16**

Supports up to 16 AC Indoor Units

**TO-AC-KNX-64**

Supports up to 64 AC Indoor Units

**INDEX**

1.	Presentation .....	5
2.	Connection .....	6
2.1	Connection of the TO-AC-KNX-16/64 to the AC indoor unit .....	6
2.2	Connection of the TO-AC-KNX-16/64 to the KNX bus: .....	6
3.	Configuration and setup .....	6
4.	ETS Parameters .....	7
4.1	General configuration dialog .....	8
4.1.1	Number of active AC Units.....	8
4.1.2	Use object "Error Code [2byte]" .....	8
4.1.3	Use object "Error Text Code [14byte]" .....	8
4.1.4	Use filter alarm Status and Reset Objs .....	9
4.1.5	Period for first status update to KNX .....	9
4.2	Global Mode Configuration dialog .....	9
4.2.1	Status_ Mode report (HEAT/COOL) when auto .....	10
4.2.2	Use of Mode Cool/Heat bit-type object .....	10
4.2.3	Use of + / - object for Mode .....	10
4.2.4	Enable use of bit-type Mode objects (for control) .....	11
4.2.5	Use of bit-type Mode objects (for status).....	11
4.2.6	Use of Text object for Mode .....	12
4.3	Global Fan Speed Configuration dialog .....	12
4.3.1	DPT object type for fanspeed .....	12
4.3.2	Use Auto/Manual Fanspeed objects (for Control and Status) .....	13
4.3.3	Enable use of +/- object for Fan Speed .....	13
4.3.4	Use of bit-type Fan Speed objects (for Control).....	14
4.3.5	Enable use of bit-type Fan Speed objects (for Status) .....	14
4.3.6	Enable use of Text object for Fan Speed .....	14
4.4	Global Vanes Configuration dialog .....	15
4.4.1	DPT object type for Vanes Up-Down .....	15
4.4.2	Enable "Control_ Vanes U-D Swing".....	16
4.4.3	Enable use of +/- object for Vanes U-D.....	17
4.4.4	Enable use of bit-type Vane U-D objects (for Control) .....	17
4.4.5	Enable use of bit-type Vane U-D objects (for Status) .....	17
4.4.6	Enable use of Text object for Vane U-D .....	18
4.5	Global Temperature Configuration dialog .....	18
4.5.1	Enable use of +/- object for Setpoint Temp .....	19
4.5.2	Ambient temp. ref. is provided from KNX .....	19
4.6	Remote Lock Configuration .....	20
4.6.1	Show Remote Lock Objects .....	20
4.6.2	ACxx Initial state of On/Off lock .....	21
4.6.3	ACxx Initial state of Mode lock .....	21
4.6.4	ACxx Initial state of Setpoint lock.....	21
4.7	Central Control units.....	22
4.8	License .....	22
5.	Specifications.....	23
6.	AC Unit Types compatibility .....	24
7.	Error Codes .....	24
8.	Appendix A – Communication Objects Table .....	25

## 1. Presentation



TO-AC-KNX-16/64 allows a complete and natural integration of TOSHIBA air conditioners with KNX control systems.

Main features:

- Reduced dimensions, quick installation.
- Direct connection to Toshiba indoor unit's TCC-Link connector.
- Multiple objects for control and status (bit, byte, characters...) with KNX standard datapoint types.
- Status objects for every control available.
- Timeout for Open Window and Occupancy. Sleep function also available.
- Configuration is made directly from ETS. The database of the device comes with a complete set of communication objects allowing, from a simple and quick integration using the basic objects, to the most advanced integration with monitoring and control of all the AC unit's parameters.
- Control of the AC unit based in the ambient temperature read by the own AC unit, or in the ambient temperature read by any KNX thermostat.
- Total Control and Monitoring of the AC unit from KNX, including monitoring of AC unit's state of internal variables, running hours counter (for filter maintenance control), and error indication and error code.

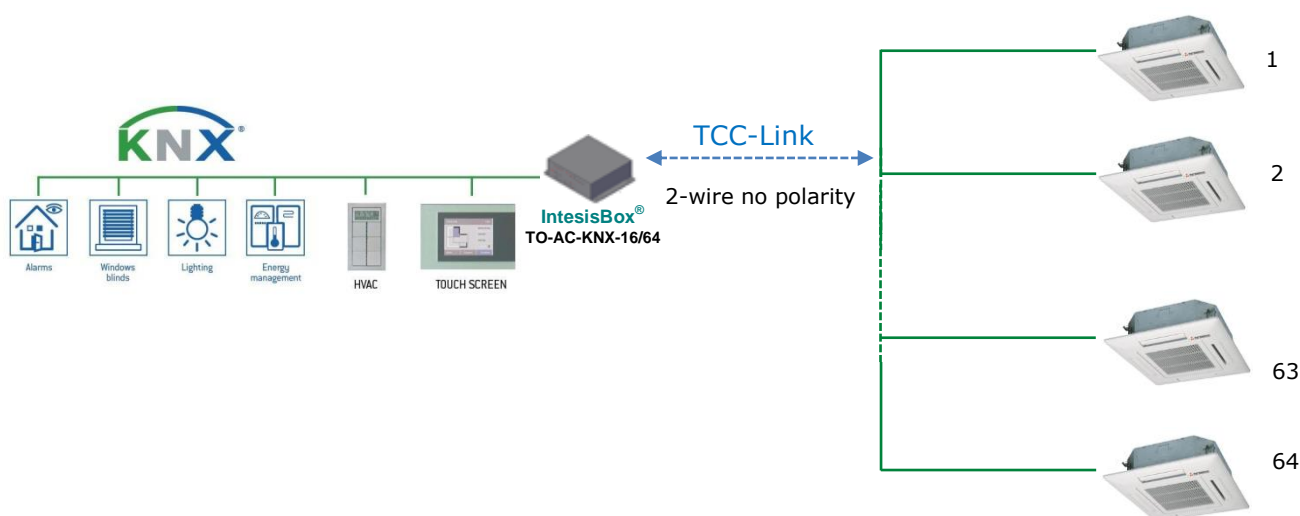

## 2. Connection

### 2.1 Connection of the TO-AC-KNX-16/64 to the AC indoor unit

The TO-AC-KNX-16/64 must be connected directly to the TCC-Link bus of Toshiba. Please, remember to use the ferrites supplied with the device to protect the TCC bus from electromagnetic interferences.

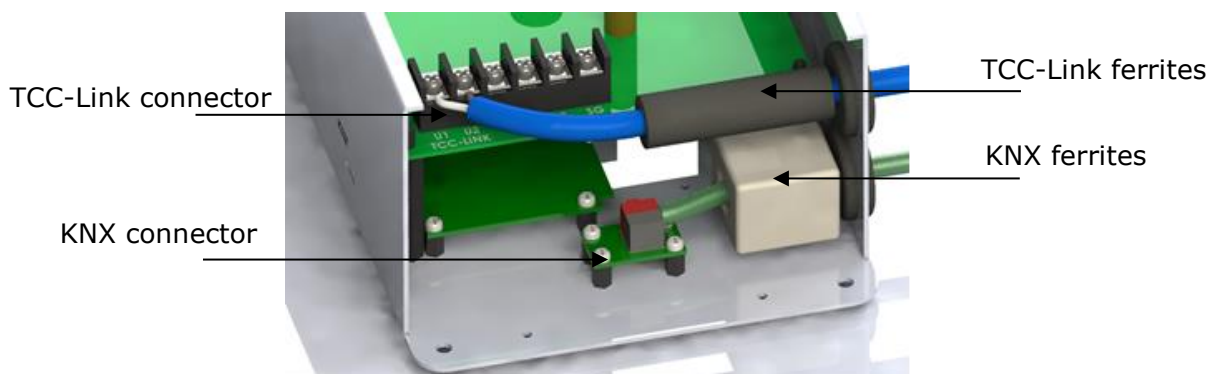

**Figure 2.1** TO-AC-KNX-16/64 connection diagrams

### 2.2 Connection of the TO-AC-KNX-16/64 to the KNX bus:

Disconnect power of the KNX bus. Connect the TO-AC-KNX-16/64 to the KNX TP-1 (EIB) bus using the KNX standard connector (red/grey) of the TO-AC-KNX-16/64, respect polarity.

Reconnect power of the KNX bus, and mains power of the AC unit.

Please, remember to use the ferrites supplied with the device to protect the KNX bus from electromagnetic interferences.

## 3. Configuration and setup

This is a fully compatible KNX device which must be configured and setup using standard KNX tool ETS.

ETS database for this device can be downloaded from:

<http://www.intesis.com/down/eib/TO-AC-KNX.zip>

Please consult the README.txt file, located inside the downloaded zip file, to find instructions on how to install the database.

**⚠ Important:** Do not forget to select the correct settings of AC indoor unit being connected to the TO-AC-KNX-16/64. This is in "Parameters" of the device in ETS.

## 4. ETS Parameters

When imported to the ETS software for the first time, the gateway shows the following default parameter configuration:

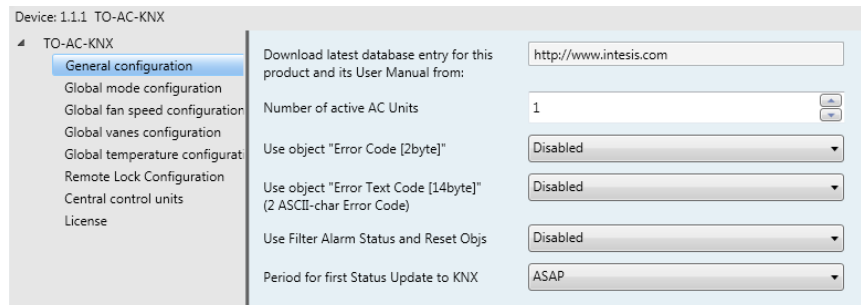

**Figure 4.1** Default parameter configuration

With this configuration it's possible to send On/Off (*ACxx Control\_ On/Off*), change the AC Mode (*ACxx<sup>1</sup> Control\_ Mode*), the Fan Speed (*ACxx Control\_ Fan Speed*), the Vanes U-D (*ACxx Control\_ Vanes U-D*) and also the Setpoint Temperature (*ACxx Control\_ Setpoint Temperature*). The Status\_ objects, for the mentioned Control\_ objects, are also available to use if needed. Also objects *Status\_ AC Return Temp* and *Status\_ Error/Alarm* are shown.

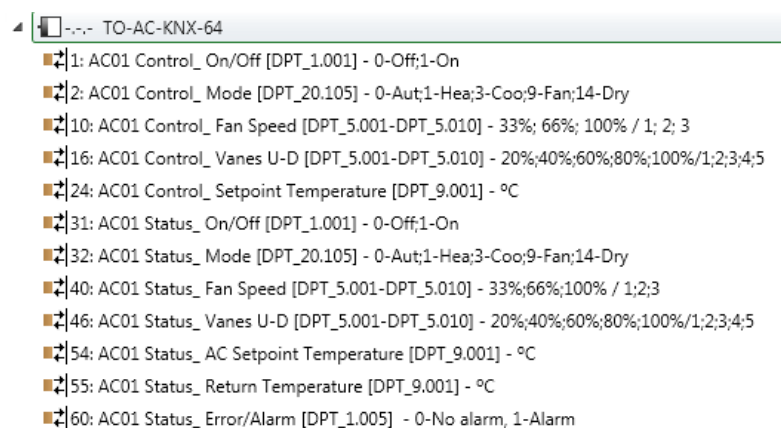

**Figure 4.2** Default communication objects

<sup>1</sup> xx corresponds to the AC indoor unit number.

## 4.1 General configuration dialog

Inside this parameter's dialog it is possible to activate or change the parameters shown in the **Figure 4.1**. The first field shows the URL where to download the database and the user manual for the product.

### 4.1.1 Number of active AC Units

This parameter is used to select the number of AC units present in the project. Remember that depending on the license you have you can control up to 16 or 64 AC indoor units.

Please check section 4.8 for more information regarding licenses and how to proceed with the activation.

### 4.1.2 Use object "Error Code [2byte]"

When this parameter is enabled, the Error code communication object will appear, allowing the error codes for each indoor unit to be available for monitoring.

- If set to **"disabled"** the gateway will not show the any action.
- If set to **"enabled"** the *Status\_ Error Code* will be shown.
  - This object can be read and also sends the indoor unit error, if occurred, in numeric format. If a **"0"** value is shown that means no error.

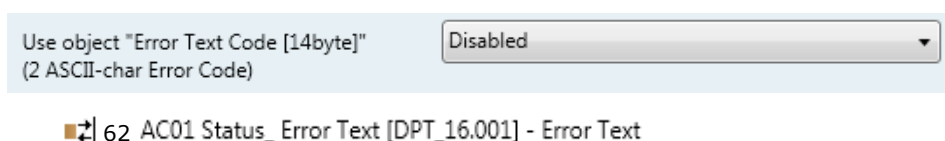

**Figure 4.3** Parameter and communication object detail

### 4.1.3 Use object "Error Text Code [14byte]"

This parameter shows/hide the *Status\_ Error Text* communication object which describes the error code as it is displayed in the Toshiba's bus.

- If set to **"disabled"** the gateway will not show the any action.
- If set to **"enabled"** the *Status\_ Error Code* will be shown.
  - This object can be read and also sends the indoor unit error, if occurred, in text format. The errors shown have the same format as at the remote controller and at the error list from the indoor unit manufacturer. If the object's value is empty that means no error.



**Figure 4.4** Parameter and communication object detail



#### 4.1.4 Use filter alarm Status and Reset Objs

This parameter shows/hides *Control\_Reset Filter* and *Status\_Filter Alarm* that lets reset the filter status and also monitor if there is a filter alarm.

- ↕ 27 AC01 Control\_Reset Filter [DPT\_1.015] - 1-Reset filter
- ↕ 56 AC01 Status\_Filter Alarm [DPT\_1.005] - 0-No alarm;1-Alarm

- If set to **"no"** the object will not be shown.
- If set to **"yes"** the *Control\_Reset Filter* y *Status\_Filter Alarm* objects will appear.
  - The *Status\_* object will show a **"0"** value when there's no filter alarm, and a **"1"** value when the filter is full. Once the filter is cleaned, the alarm can be reset by sending a **"1"** value to the *Control\_Reset Filter* object.

#### 4.1.5 Period for first status update to KNX

This parameter defines how fast the status is updated to KNX. Depending on the value selected, more or less priority will be assigned to this action. As there are so many parameters available, it is important to consider carefully how to set this parameter.

- If set to **"ASAP"**, all status communication objects will send its value (if needed).
- If set to **"Slow"**, all status communication objects will send its value (if needed), but slower than in the previous option (ASAP).
- If set to **"Super Slow"**, all status communication objects will send its value (if needed), but slower than in the previous option (Slow).

## 4.2 Global Mode Configuration dialog

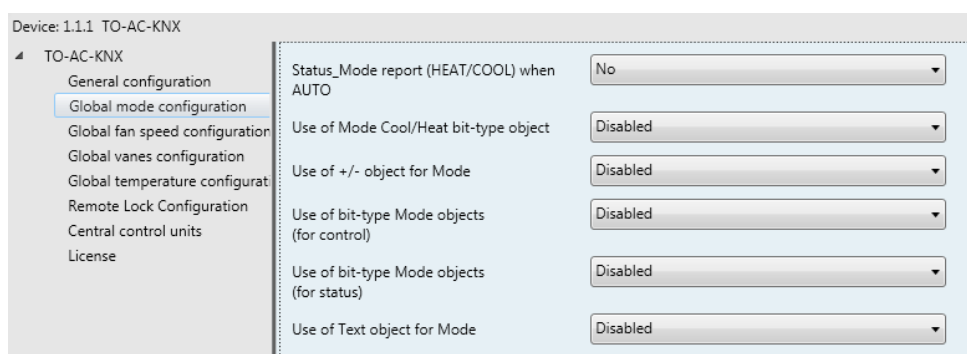

Figure 4.6 Default Mode Configuration dialog

All the parameters in this section are related with the different mode properties and communication objects.

- ↕ 2 AC01 Control\_Mode [DPT\_20.105] - 0-Aut;1-Hea;3-Coo;9-Fan;14-Dry

The byte-type communication object for Mode works with the DTP\_20.105. Auto mode will be enabled with a "0" value, Heat mode with a "1" value, Cool mode with a "3" value, Fan mode with a "9" value and Dry mode with a "14" value.

#### 4.2.1 Status\_ Mode report (HEAT/COOL) when auto

This parameter is used to indicate if the indoor unit reports if the AC system is working on Heat or Cool mode when it is in auto mode.

- If set to "no", the sistem is not reporting the working mode when on auto.
- If set to "yes", the sistem is reports the working mode when on auto.

#### 4.2.2 Use of Mode Cool/Heat bit-type object

This parameter shows/hides the *Control\_* and *Status\_ Mode Cool/Heat* communication objects.

```

■ ↕ 3 AC01 Control_ Mode Cool/Heat [DPT_1.100] - 0-Cool; 1-Heat
■ ↕ 33 AC01 Status_ Mode Cool/Heat [DPT_1.100] - 0-Cool; 1-Heat

```

- If set to "no" the objects will not be shown.
- If set to "yes" the *Control\_* and *Status\_ Mode Cool/Heat* objects will appear.
  - When a "1" value is sent to the *Control\_* communication object, **Heat mode** will be enabled in the indoor unit, and the *Status\_* object will return this value.
  - When a "0" value is sent to the *Control\_* communication object, **Cool mode** will be enabled in the indoor unit, and the *Status\_* object will return this value.

#### 4.2.3 Use of + / - object for Mode

This parameter shows/hides the *Control\_ Mode +/-* communication object which lets change the indoor unit mode by using two different datapoint types.

```

■ ↕ 9 AC01 Control_ Mode +/- [DPT_1.007-DPT_1.008] - 0-Dec;1-Inc. / 0-Up;1-Down

```

- If set to "no" the object will not be shown.
- If set to "yes" the *Control\_ Mode +/-* object and a new parameter will appear.

Enable use of +/- object for Mode	yes
> DPT type for +/- Mode Object	0-Up / 1-Down [DPT_1.008]

Figure 4.7 Parameter detail

➤ DPT type for +/- Mode Object

This parameter lets choose between the datapoints **0-Up / 1-Down [DPT\_1.008]** and **0-Decrease / 1-Increase [DPT\_1.007]** for the *Control\_ Mode +/-* object.

The sequence followed when using this object is shown below:



- Up / Increase
- Down / Decrease

⚠ **Important:** Read the documentation of your indoor unit to check if it has HEAT mode available.

#### 4.2.4 Enable use of bit-type Mode objects (for control)

This parameter shows/hides the bit-type *Control\_ Mode* objects.

- ↕ 4 AC01 Control\_ Mode Auto [DPT\_1.002] - 1-Set AUTO mode
- ↕ 5 AC01 Control\_ Mode Heat [DPT\_1.002] - 1-Set HEAT mode
- ↕ 6 AC01 Control\_ Mode Cool [DPT\_1.002] - 1-Set COOL mode
- ↕ 7 AC01 Control\_ Mode Fan [DPT\_1.002] - 1-Set FAN mode
- ↕ 8 AC01 Control\_ Mode Dry [DPT\_1.002] - 1-Set DRY mode

- If set to **"no"** the objects will not be shown.
- If set to **"yes"** the *Control\_ Mode* objects for Auto, Heat, Cool, Fan and Dry will appear. To activate a mode by using these objects a **"1"** value has to be sent.

#### 4.2.5 Use of bit-type Mode objects (for status)

This parameter shows/hides the bit-type *Status\_ Mode* objects.

- ↕ 34 AC01 Status\_ Mode Auto [DPT\_1.002] - 1-Set AUTO mode
- ↕ 35 AC01 Status\_ Mode Heat [DPT\_1.002] - 1-Set HEAT mode
- ↕ 36 AC01 Status\_ Mode Cool [DPT\_1.002] - 1-Set COOL mode
- ↕ 37 AC01 Status\_ Mode Fan [DPT\_1.002] - 1-Set FAN mode
- ↕ 38 AC01 Status\_ Mode Dry [DPT\_1.002] - 1-Set DRY mode

- If set to **"no"** the objects will not be shown.
- If set to **"yes"** the *Status\_ Mode* objects for Auto, Heat, Cool, Fan and Dry will appear. When enabled, a mode will return a **"1"** through its bit-type object.

### 4.2.6 Use of Text object for Mode

This parameter shows/hides the *Status\_ Mode Text* communication object.

39 AC01 Status\_ Mode Text [DPT\_16.001] - Mode Text

- If set to **“no”** the object will not be shown.
- If set to **“yes”** the *Status\_ Mode Text* object will appear. Also, in the parameters, will be shown five text fields, one for each mode, that will let modify the text string displayed by the *Status\_ Mode Text* when changing mode.

> String when mode is AUTO	AUTO
> String when mode is HEAT (if available)	HEAT
> String when mode is COOL	COOL
> String when mode is FAN	FAN
> String when mode is DRY	DRY

**Figure 4.8** Parameter detail

## 4.3 Global Fan Speed Configuration dialog

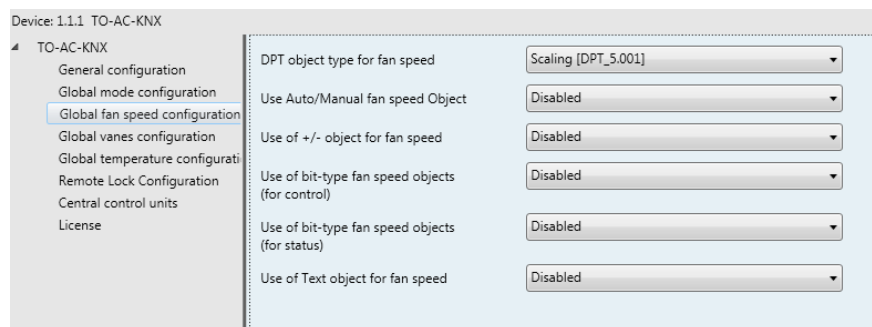

**Figure 4.9** Fan Speed Configuration dialog

All the parameters in this section are related with the Fan Speed properties and communication objects.

### 4.3.1 DPT object type for fanspeed

With this parameter is possible to change the DPT for the *Control\_ Fan Speed* and *Status\_ Fan Speed* byte-type communication objects. Datapoints Scaling (DPT\_5.001) and Enumerated (DPT\_5.010) can be selected.

**⚠ Important:** The communication objects shown in this section may be different depending on the number of fan speeds available, although they all share the same communication object number.

- When **“Enumerated [DPT 5.010]”** is selected, *Control\_ Fan Speed* and *Status\_ Fan Speed* communication objects for this DPT will appear.

- ↕ 10 AC01 Control\_ Fan Speed [DPT\_5.010] - 1;2;3
- ↕ 40 AC01 Status\_ Fan Speed [DPT\_5.010] - 1;2;3

The first fan speed will be selected if a "1" is sent to the *Control\_* object. The second one will be selected sending a "2"; the third one will be selected sending a "3".

The *Status\_* object will always return the value for the fan speed selected.

**△ Important:** If a "0" value is sent to the *Control\_* object, the minimum fan speed will be selected. If a value bigger than "3" is sent to the *Control\_* object, then the maximum fan speed will be selected.

- When "Scaling [DPT 5.001]" is selected, *Control\_ Fan Speed* and *Status\_ Fan Speed* communication objects for this DPT will appear.

- ↕ 10 AC01 Control\_ Fan Speed [DPT\_5.001] - 33%;66%;100%
- ↕ 40 AC01 Status\_ Fan Speed [DPT\_5.001] - 33%;66%;100%

The next table shows the range of values that can be sent through the *Control\_* object and the value returned by the *Status\_* object.

	Fan Speed 1	Fan Speed 2	Fan Speed 3
Control_	0% - 33%	34% - 66%	67% - 100%
Status_	33%	66%	100%

**△ Important:** Read the documentation of your indoor unit to check how many fan speeds are available.

#### 4.3.2 Use Auto/Manual Fanspeed objects (for Control and Status)

This parameter shows/hides the bit-type *Control\_ Fan Speed Man/Auto* and the *Status\_ Fan Speed Man/Auto* objects.

- ↕ 11 AC01 Control\_ Fan Speed Man/Auto [DPT\_1.002] - 0-Manual;1-Auto
- ↕ 41 AC01 Status\_ Fan Speed Man/Auto [DPT\_1.002] - 0-Manual;1-Auto

#### 4.3.3 Enable use of +/- object for Fan Speed

This parameter shows/hides the *Control\_ Fan Speed +/-* communication object which lets increase/decrease the indoor unit fan speed by using two different datapoint types.

- ↕ 15 AC01 Control\_ Fan Speed +/- [DPT\_1.008] - 0-Up;1-Down

- If set to "no" the object will not be shown.

- If set to **"yes"** the *Control\_ Fan Speed +/-* object and a new parameter will appear.

The screenshot shows a configuration interface with two dropdown menus. The first dropdown is labeled 'Use of +/- object for fanspeed' and is set to 'Enabled'. The second dropdown is labeled '> Fan Speed operation' and is set to '0-Up / 1-Down [DPT\_1.008]'.

Figure 4.13 Parameter detail

➤ Fan Speed operation

This parameter lets choose between the datapoints **0-Up / 1-Down [DPT\_1.008]** and **0-Decrease / 1-Increase [DPT\_1.007]** for the *Control\_ Fan Speed +/-* object.

#### 4.3.4 Use of bit-type Fan Speed objects (for Control)

This parameter shows/hides the bit-type *Control\_ Fan Speed* objects.

- ↕ 12 Control\_ Fan Speed 1 [DPT\_1.002 - 1bit] - 1-Set Fan Speed 1
- ↕ 13 Control\_ Fan Speed 2 [DPT\_1.002 - 1bit] - 1-Set Fan Speed 2
- ↕ 14 Control\_ Fan Speed 3 [DPT\_1.002 - 1bit] - 1-Set Fan Speed 3

- If set to **"no"** the objects will not be shown.
- If set to **"yes"** the *Control\_ Fan Speed* objects for Speed 1, Speed 2 and Speed 3 will appear. To activate a Fan Speed by using these objects a **"1"** value has to be sent.

#### 4.3.5 Enable use of bit-type Fan Speed objects (for Status)

This parameter shows/hides the bit-type *Status\_ Fan Speed* objects.

- ↕ 42 AC01 Status\_ Fan Speed 1 [DPT\_1.002] - 1-Set Fan Speed 1
- ↕ 43 AC01 Status\_ Fan Speed 2 [DPT\_1.002] - 1-Set Fan Speed 2
- ↕ 44 AC01 Status\_ Fan Speed 3 [DPT\_1.002] - 1-Set Fan Speed 3

- If set to **"no"** the objects will not be shown.
- If set to **"yes"** the *Status\_ Fan Speed* objects for Speed 1, Speed 2 and Speed 3 will appear. When a Fan Speed is enabled, a **"1"** value is returned through its bit-type object.

#### 4.3.6 Enable use of Text object for Fan Speed

This parameter shows/hides the *Status\_ Fan Speed Text* communication object.

- ↕ 45 AC01 Status\_ Fan Speed Text [DPT\_16.001] - Fan Speed Text

- If set to **“no”** the object will not be shown.
- If set to **“yes”** the *Status\_ Fan Speed Text* object will appear. Also, in the parameters, will be shown five text fields, one for each Fan Speed, that will let modify the text string displayed by the *Status\_ Fan Speed Text* when changing a fan speed.

> String when fan speed is 1	SPEED 1
> String when fan speed is 2	SPEED 2
> String when fan speed is 3	SPEED 3
> String when fan speed is AUTO	AUTO

**Figure 4.14** Parameter detail

## 4.4 Global Vanes Configuration dialog

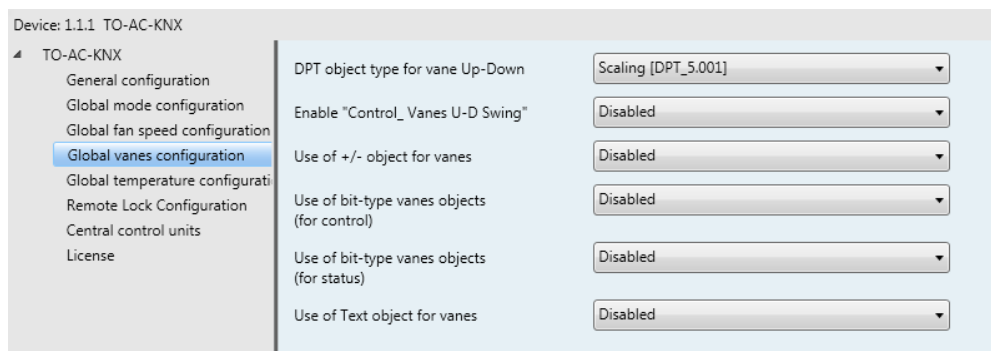

**Figure 4.15** Vanes Up-Down Configuration dialog

All the parameters in this section are related with the Vanes Up-Down properties and communication objects.

### 4.4.1 DPT object type for Vanes Up-Down

With this parameter is possible to change the DPT for the *Control\_Vanes U-D* and *Status\_Vanes U-D* byte-type communication objects. Datapoints Scaling (DPT\_5.001) and Enumerated (DPT\_5.010) can be selected.

**⚠ Important:** *The communication objects shown in this section may be different depending on the number of vanes position available, although they all share the same communication object number.*

- When **“Enumerated [DPT 5.010]”** is selected, *Control\_Vanes U-D* and *Status\_Vanes U-D* communication objects for this DPT will appear.

```

■ ↕ 16 AC01 Control_Vanes U-D [DPT_5.001] - 20%;40%;60%;80%;100%
■ ↕ 46 AC01 Status_Vanes U-D [DPT_5.001] - 20%;40%;60%;80%;100%

```

To choose a vanes position, values from "1" to "5" can be sent to the *Control\_* object. Each value will correspond to the position (i.e. Value "3" = Position 3).

The *Status\_* object will always return the value for the vane position selected.

**⚠ Important:** If a "0" value is sent to the *Control\_* object, the Position 1 will be selected. If a value bigger than "5" is sent to the *Control\_* object, then the higher Position will be selected.

- When "Scaling [DPT 5.001]" is selected, *Control\_ Vane Up-Down* and *Status\_ Vane Up-Down* communication objects for this DPT will appear.

- ↕ 16 *Control\_ Vanes U-D / 5 Pos* [DPT\_5.001 - 1byte] - Thresholds:30%,50%,70% and 90%
- ↕ 46 *Status\_ Vanes U-D / 5 Pos* [DPT\_5.001 - 1byte] - 20%, 40%, 60%, 80% and 100%

The next table shows the range of values that can be sent through the *Control\_* object and the value returned by the *Status\_* object.

	Vanes Pos.1	Vanes Pos.2	Vanes Pos.3	Vanes Pos.4	Vanes Pos.5
<i>Control_</i>	0% - 20%	21% - 40%	41% - 60%	61% - 80%	81% - 100%
<i>Status_</i>	20%	40%	60%	80%	100%

#### 4.4.2 Enable "Control\_ Vanes U-D Swing"

This parameter lets choose if the unit has any of the two available modes for vanes directions.



Figure 4.16 Parameter detail

- If set to "Disabled" all the parameters and communication objects for the for the 5 Vanes positions will not be shown and communication objects only for SWING and STANDBY will be shown.
- If set to "Enabled" all the parameters and communication objects (if enabled in the parameters dialog) for the swing positions will be shown.

- ↕ 17 *Control\_ Vanes U-D Swing* [DPT\_1.002 - 1bit] - 0-Off;1-Swing
- ↕ 47 *Status\_ Vanes U-D Swing* [DPT\_1.002 - 1bit] - 0-Off;1-Swing

**⚠ Important:** Read the documentation of your indoor unit to check if Up-Down Vanes Swing is available.



### 4.4.3 Enable use of +/- object for Vanes U-D

This parameter shows/hides the *Control\_ Vane Up-Down +/-* communication object which lets change the indoor unit vane position by using two different datapoint types.

➡| 23 Control\_ Vanes U-D +/- [DPT\_1.007 - 1bit] - 0-Decrease;1-Increase

- If set to **"no"** the object will not be shown.
- If set to **"yes"** the *Control\_ Vanes U-D +/-* object and a new parameter will appear.

The screenshot shows a configuration interface with two dropdown menus. The first dropdown is labeled 'Use of +/- object for vanes' and is set to 'Enabled'. The second dropdown is labeled '> Vane UD operation' and is set to '0-Decrease / 1-Increase [DPT\_1.007]'.

Figure 4.17 Parameter detail

#### ➤ Vane UD operation

This parameter lets choose between the datapoints **0-Up / 1-Down [DPT\_1.008]** and **0-Decrease / 1-Increase [DPT\_1.007]** for the *Control\_ Vanes U-D +/-* object.

### 4.4.4 Enable use of bit-type Vane U-D objects (for Control)

This parameter shows/hides the bit-type *Control\_ Vanes U-D* objects.

➡| 18 Control\_ Vanes U-D Pos 1 [DPT\_1.002 - 1bit] - 1-Set Position 1  
 ➡| 19 Control\_ Vanes U-D Pos 2 [DPT\_1.002 - 1bit] - 1-Set Position 2  
 ➡| 20 Control\_ Vanes U-D Pos 3 [DPT\_1.002 - 1bit] - 1-Set Position 3  
 ➡| 21 Control\_ Vanes U-D Pos 4 [DPT\_1.002 - 1bit] - 1-Set Position 4  
 ➡| 22 Control\_ Vanes U-D Pos 5 [DPT\_1.002 - 1bit] - 1-Set Position 5

- If set to **"no"** the objects will not be shown.
- If set to **"yes"** the *Control\_ Vanes U-D* objects for each Position will appear. To activate a Vanes Position by using these objects, a **"1"** value has to be sent.

### 4.4.5 Enable use of bit-type Vane U-D objects (for Status)

This parameter shows/hides the bit-type *Status\_ Vanes U-D* objects.

➡| 48 Status\_ Vanes U-D Pos 1 [DPT\_1.002 - 1bit] - 1-Vanes in Position 1  
 ➡| 49 Status\_ Vanes U-D Pos 2 [DPT\_1.002 - 1bit] - 1-Vanes in Position 2  
 ➡| 50 Status\_ Vanes U-D Pos 3 [DPT\_1.002 - 1bit] - 1-Vanes in Position 3  
 ➡| 51 Status\_ Vanes U-D Pos 4 [DPT\_1.002 - 1bit] - 1-Vanes in Position 4  
 ➡| 52 Status\_ Vanes U-D Pos 5 [DPT\_1.002 - 1bit] - 1-Vanes in Position 5

- If set to **"no"** the objects will not be shown.
- If set to **"yes"** the *Status\_ Vanes U-D* objects for each Position will appear. When a Vanes Position is enabled, a **"1"** value is returned through its bit-type object.

#### 4.4.6 Enable use of Text object for Vane U-D

This parameter shows/hides the *Status\_ Vanes U-D Text* communication object.

53 Status\_ Vanes U-D Text [DPT\_16.001 - 14byte] - ASCII String

- If set to **"no"** the object will not be shown.
- If set to **"yes"** the *Status\_ Vanes U-D Text* object will appear. Also, in the parameters will be shown seven text fields, five for the Vane Position and one for the Auto function and another one for the Swing function, that will let modify the text string displayed by the *Status\_ Vanes U-D Text* when changing a vane position.

> String when vanes U-D is in POS1	U-D POS1
> String when vanes U-D are in POS2	U-D POS2
> String when vanes U-D are in POS3	U-D POS3
> String when vanes U-D are in POS4	U-D POS4
> String when vanes U-D are in POS5	U-D POS5
> String when vanes U-D are in SWING	U-D SWING
> String when vanes U-D are in STOP	U-D STOP

Figure 4.19 Parameter detail

## 4.5 Global Temperature Configuration dialog

Device: 1.1.1 TO-AC-KNX

TO-AC-KNX

- General configuration
- Global mode configuration
- Global fan speed configuration
- Global vanes configuration
- Global temperature configuration
- Remote Lock Configuration
- Central control units
- License

Use of +/- object for Setpoint Temp. Disabled

Ambient temp.ref. is provided from KNX (carefully read User Guide if enabled) Disabled

Figure 4.20 Default Temperature Configuration dialog

All the parameters in this section are related with the Temperature properties and communication objects.

### 4.5.1 Enable use of +/- object for Setpoint Temp

This parameter shows/hides the *Control\_ Setpoint Temp +/-* communication object which lets change the indoor unit setpoint temperature by using two different datapoint types.





■ ↕ 25 Control\_ Setpoint Temp +/- [DPT\_1.007 - 1bit] - 0-Decrease;1-Increase

- If set to **"no"** the object will not be shown.
- If set to **"yes"** the *Control\_ Setpoint Temp +/-* object and a new parameter will appear.

Figure 4.22 Parameter detail

#### ➤ Setpoint operation

This parameter lets choose between the datapoints **0-Up / 1-Down [DPT\_1.008]** and **0-Decrease / 1-Increase [DPT\_1.007]** for the *Control\_ Setpoint Temp +/-* object.

(Lower limit) **18°C**  19°C  ...  28°C  **27°C** (Upper limit)

- Up / Increase
- Down / Decrease

### 4.5.2 Ambient temp. ref. is provided from KNX

This parameter shows/hides the *Control\_ Ambient Temperature* communication object which lets use an ambient temperature reference provided by a KNX device.

■ ↕ 26 Control\_ Ambient Temperature [DPT\_9.001 - 2byte] - (°C)

- If set to **"no"** the object will not be shown.
- If set to **"yes"** the *Control\_ Ambient Temperature* object will appear. Meant to be enabled when you want the temperature provided by a KNX sensor to be the reference ambient temperature for the air conditioner. Then, the following formula applies for calculation of real *Control\_ Setpoint Temperature* sent to the AC unit:

$$\text{"AC Setp. Temp"} = \text{"AC Ret. Temp"} - (\text{"KNX Amb. Temp."} - \text{"KNX Setp. Temp"})$$

- AC Setp. Temp: AC indoor unit setpoint temperature
- AC Ret. Temp: AC indoor unit return temperature
- KNX Amb. Temp.: Ambient temperature provided from KNX
- KNX Setp. Temp: Setpoint temperature provided from KNX

As an example, consider the following situation:

User wants: **19°C** ("KNX Setp. Temp.")

User sensor (a KNX sensor) reads: **21°C** ("KNX Amb Temp.")

Ambient temp. read by Mitsubishi system is: **24°C** ("AC Ret. Temp")

In this example, the final setpoint temperature that ME-AC-KNX-1 will send out to the indoor unit (shown in "Setp. Temp.") will become  $24^{\circ}\text{C} - (21^{\circ}\text{C} - 19^{\circ}\text{C}) = \mathbf{22^{\circ}\text{C}}$ . This is the setpoint that will actually be requested to Mitsubishi Electric unit.

This formula will be applied as soon as the *Control\_Setpoint Temperature* and *Control\_Ambient Temperature* objects are written at least once from the KNX installation. After that, they are kept always consistent.

Note that this formula will always drive the AC indoor unit demand in the *right* direction, regardless of the operation mode (Heat, Cool or Auto).

## 4.6 Remote Lock Configuration

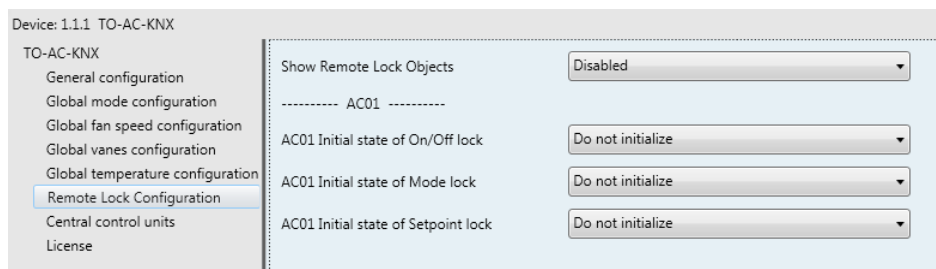

**Figure 4.24** Parameter detail

All the parameters in this section are related to each AC unit and its Remote Control commands.

### 4.6.1 Show Remote Lock Objects

This parameter is used to show or hide the remote lock objects related to each indoor unit.

- ➡| 28 AC01 Control\_ Remote Lock On/Off [DPT\_1.003] - 0-Disable;1-Enable
- ➡| 29 AC01 Control\_ Remote Lock Mode [DPT\_1.003] - 0-Disable;1-Enable
- ➡| 30 AC01 Control\_ Remote Lock Setp Temp [DPT\_1.003] - 0-Disable;1-Enable
  
- ➡| 57 AC01 Status\_ Remote Lock On/Off [DPT\_1.003] - 0-Disable;1-Enable
- ➡| 58 AC01 Status\_ Remote Lock Mode [DPT\_1.003] - 0-Disable;1-Enable
- ➡| 59 AC01 Status\_ Remote Lock Setpoint Temp [DPT\_1.003] - 0-Disable;1-Enat

**Figure 4.24** Communication objects shown regarding Remote Lock Objects

#### 4.6.2 ACxx Initial state of On/Off lock

This parameter is used to define if the remote controller of the AC system is capable of controlling the On/Off function on start.

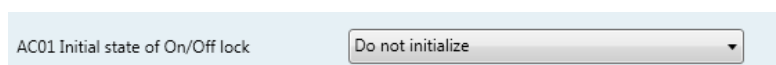

Figure 4.25 Parameter detail

- If set to **“Do not initialize”**, the remote controller of the AC system will be set into its last status regarding the On/Off lock function.
- If set to **“Start unlocked”**, the remote controller of the AC system will be able to command the On/Off order of the AC unit.
- If set to **“Start locked”**, the remote controller of the AC system will not be able to command the On/Off order of the AC unit.

#### 4.6.3 ACxx Initial state of Mode lock

This parameter is used to define if the remote controller of the AC system is capable of controlling the current Mode.

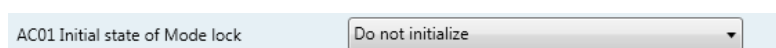

Figure 4.27 Parameter detail

- If set to **“Do not initialize”**, the remote controller of the AC system will be set into its last status regarding the Mode lock function.
- If set to **“Start unlocked”**, the remote controller of the AC system will be able to command the current mode of the AC unit.
- If set to **“Start locked”**, the remote controller of the AC system will not be able to command the current mode of the AC unit.

#### 4.6.4 ACxx Initial state of Setpoint lock.

This parameter is used to define if the remote controller of the AC system is capable of controlling the Setpoint temperature.

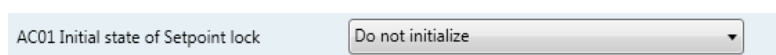

Figure 4.28 Parameter detail

- If set to **“Do not initialize”**, the remote controller of the AC system will be set into its last status regarding the Mode lock function.
- If set to **“Start unlocked”**, the remote controller of the AC system will be able to command the Setpoint temperature of the AC unit.

- If set to **“Start locked”**, the remote controller of the AC system will not be able to command the Setpoint temperature of the AC unit.

## 4.7 Central Control units

This parameter is used to change the Central Control address of the AC units. Use this parameter if you need to change the by default addressing of the Central Control addresses for each indoor unit to match any specification of the AC system integrator.

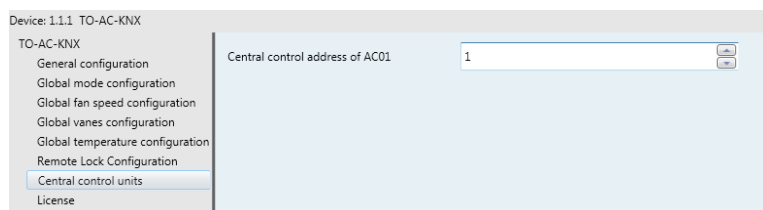

Figure 4.29 Parameter detail

## 4.8 License

This field must be used only if you need to move from the TO-AC-KNX-16 to the TO-AC-KNX-64 version. Please, contact our sales department to ask for a license upgrade.

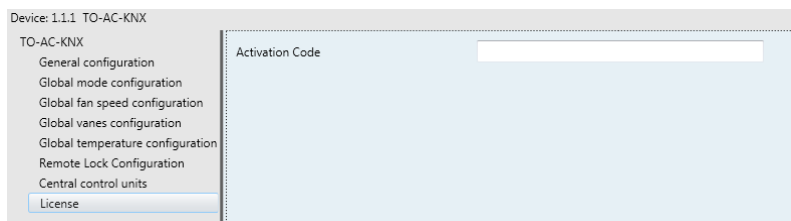

Figure 4.30 Parameter detail

## 5. Specifications



Enclosure	Industrial sheet metal. Size: 217mm x 147mm x 90mm. Weight: 1.500 Kg
Color	Gray metalized.
Power	100 to 240VAC~ 50 to 60Hz 5W max. Power connector: C14 (male) <sup>2</sup>
Fuse	250V 1.5A Dimensions: 20x5mm
Terminal wiring (for low-voltage signals)	Per terminal: solid wires or stranded wires (twisted or with ferrule) 1 core: 0.75mm <sup>2</sup> ... 1.25mm <sup>2</sup> 2 cores: 0.75mm <sup>2</sup> ... 1.25mm <sup>2</sup> 3 cores: not permitted
Mounting	Wall
KNX port	1 x KNX TP1 (EIB) opto-isolated (Plug-in screw terminal block 2 poles)
TCC-LINK port	1 x TCC-LINK connector (Plug-in screw terminal block 2 poles "U1" "U2"). SELV
LED indicators	5 x Toshiba Interface (POWER, RS485, TCC-LINK, ERROR, TEST) 1 x KNX port link and activity
Push buttons	1 x KNX programming button
Operational temperature range	0°C to +40°C
Operational humidity range	5% to 95%, non-condensing
Protection	IP20 (IEC60529).
RoHS conformity	Compliant with RoHS directive (2002/95/CE).
Norms and standards	CE conformity to EMC directive (2004/108/EC) and Low-voltage directive (2006/95/EC) EN 61000-6-2 ; EN 61000-6-3 ; EN 60950-1 ; EN 50491-3

<sup>2</sup> A power cable with connector C14 male 1.6 meters long is supplied with the device.

## 6. AC Unit Types compatibility

A list of Toshiba indoor unit model references compatible with TO-AC-KNX-16/64 and their available features can be found in:

[http://www.intesis.com/pdf/IntesisBox\\_TO-AC-xxx-1\\_Compatibility.pdf](http://www.intesis.com/pdf/IntesisBox_TO-AC-xxx-1_Compatibility.pdf)

## 7. Error Codes

Please, check the error code of your AC system for more information or contact your nearest Toshiba technical support service.



## 8. Appendix A – Communication Objects Table

TOPIC	OBJECT NUMBER	NAME	LENGTH	DATAPOINT TYPE		FLAGS				FUNCTION
				DPT_NAME	DPT_ID	R	W	T	U	
On/Off	1	ACxx Control_ On/Off	1 bit	DPT_Switch	1.001		W	T		0 - Off; 1-On
Mode	2	ACxx Control_ Mode	1 byte	DPT_HVACContrMode	20.105		W	T		0 - Auto; 1 - Heat; 3 - Cool; 9 - Fan; 14 - Dry
	3	ACxx Control_ Mode Cool/Heat	1 bit	DPT_Heat/Cool	1.100		W	T		0 - Cool; 1 - Heat;
	4	ACxx Control_ Mode Auto	1 bit	DPT_Bool	1.002		W	T		1 - Auto
	5	ACxx Control_ Mode Heat	1 bit	DPT_Bool	1.002		W	T		1 - Heat
	6	ACxx Control_ Mode Cool	1 bit	DPT_Bool	1.002		W	T		1 - Cool
	7	ACxx Control_ Mode Fan	1 bit	DPT_Bool	1.002		W	T		1 - Fan
	8	ACxx Control_ Mode Dry	1 bit	DPT_Bool	1.002		W	T		1 - Dry
	9	ACxx Control_ Mode +/-	1 bit	DPT_Step	1.007		W			0 - Decrease; 1 - Increase
		ACxx Control_ Mode +/-	1 bit	DPT_UpDown	1.008		W			0 - Up; 1 - Down
Fan Speed	10	ACxx Control_ Fan Speed / 3 Speeds	1 byte	DPT_Scaling	5.001		W	T		0%-49% - Speed 1; 50%-82% - Speed 2; 83%-100% - Speed 3;
		ACxx Control_ Fan Speed / 3 Speeds	1 byte	DPT_Enumerated	5.010		W	T		1 - Speed 1; 2 - Speed 2; 3 Speed 3;
	11	ACxx Control_ Fan Speed Man/Auto	1 bit	DPT_Bool	1.002		W	T		0 - Manual; 1 - Auto
	12	ACxx Control_ Fan Speed 1	1 bit	DPT_Bool	1.002		W	T		1 - Set Fan Speed 1
	13	ACxx Control_ Fan Speed 2	1 bit	DPT_Bool	1.002		W	T		1 - Set Fan Speed 2
	14	ACxx Control_ Fan Speed 3	1 bit	DPT_Bool	1.002		W	T		1 - Set Fan Speed 3
	15	ACxx Control_ Fan Speed +/-	1 bit	DPT_Step	1.007		W			0 - Decrease; 1 - Increase
ACxx Control_ Fan Speed +/-		1 bit	DPT_UpDown	1.008		W			0 - Up; 1 - Down	

Vanes Up-Down	16	ACxx Control_ Vanes U-D	1 byte	DPT_Scaling	5.001		W	T	0%-29% - Pos1; 30%-49% - Pos2; 50%-69% Pos3; 70%-89% - Pos4; 90%-100% - Pos5
		ACxx Control_ Vanes U-D	1 byte	DPT_Enumerated	5.010		W	T	1 - Pos1; 2 - Pos2; 3 - Pos3; 4 - Pos4; 5 - Pos5
	17	ACxx Control_ Vanes U-D Swing	1 bit	DPT_Bool	1.002		W	T	0 - Off; 1 - Swing
	18	ACxx Control_ Vanes U-D Pos1	1 bit	DPT_Bool	1.002		W	T	1 - Set Position 1
	19	ACxx Control_ Vanes U-D Pos2	1 bit	DPT_Bool	1.002		W	T	1 - Set Position 2
	20	ACxx Control_ Vanes U-D Pos3	1 bit	DPT_Bool	1.002		W	T	1 - Set Position 3
	21	ACxx Control_ Vanes U-D Pos4	1 bit	DPT_Bool	1.002		W	T	1 - Set Position 4
	22	ACxx Control_ Vanes U-D Pos5	1 bit	DPT_Bool	1.002		W	T	1 - Set Position 5
	23	ACxx Control_ Vanes U-D +/-	1 bit	DPT_Step	1.007		W		0 - Decrease; 1 - Increase
ACxx Control_ Vanes U-D +/-		1 bit	DPT_UpDown	1.008		W		0 - Up; 1 - Down	
Temperature	24	ACxx Control_ Setpoint Temperature	2 byte	DPT_Value_Temp	9.001		W	T	(°C)
	25	ACxx Control_ Ambient Temperature	2 byte	DPT_Value_Temp	9.001		W	T	(°C)
	26	ACxx Control_ Setpoint Temp +/-	1 bit	DPT_Step	1.007		W		0 - Decrease; 1 - Increase
		ACxx Control_ Setpoint Temp +/-	1 bit	DPT_UpDown	1.008		W		0 - Up; 1 - Down
Filter	27	ACxx Control_ Reset Filter	1 bit	DPT_Bool	1.015		W	T	1 - Reset filter
Lock	28	ACxx Control_ Lock On/Off	1 bit	DPT_Bool	1.003		W	T	0 - Disabled; 1 - Enabled
	29	ACxx Control_ Lock Mode	1 bit	DPT_Start	1.003		W	T	0 - Disabled; 1 - Enabled
	30	ACxx Control_ Lock Set Temp	1 bit	DPT_Start	1.003		W	T	0 - Disabled; 1 - Enabled

**NOTE:** Object number is only referred to the first AC unit (AC01). In order to get the rest of the AC units object number for each communication object, please use the formula below:

$$\text{AC xx Object Number} = (\text{xx}-1) * 62 + \text{current Object Number}$$

<b>On/Off</b>	<b>31</b>	ACxx Status_ On/Off	1 bit	DPT_Switch	1.001	R		T	0 - Off; 1-On
<b>Mode</b>	<b>32</b>	ACxx Status_ Mode	1 byte	DPT_HVACContrMode	20.105	R		T	0 - Auto; 1 - Heat; 3 - Cool; 9 - Fan; 14 - Dry
	<b>33</b>	ACxx Status_ Mode Cool/Heat	1 bit	DPT_Heat/Cool	1.100	R		T	0 - Cool; 1 - Heat
	<b>34</b>	ACxxStatus_ Mode Auto	1 bit	DPT_Bool	1.002	R		T	1 - Auto
	<b>35</b>	ACxx Status_ Mode Heat	1 bit	DPT_Bool	1.002	R		T	1 - Heat
	<b>36</b>	ACxx Status_ Mode Cool	1 bit	DPT_Bool	1.002	R		T	1 - Cool
	<b>37</b>	ACxx Status_ Mode Fan	1 bit	DPT_Bool	1.002	R		T	1 - Fan
	<b>38</b>	ACxx Status_ Mode Dry	1 bit	DPT_Bool	1.002	R		T	1 - Dry
	<b>39</b>	ACxx Status_ Mode Text	14 byte	DPT_String_8859_1	16.001	R		T	ASCII String
<b>Fan Speed</b>	<b>40</b>	ACxx Status_ Fan Speed / 3 Speeds	1 byte	DPT_Scaling	5.001		W	T	33% - Speed 1; 67% - Speed 2; 100% - Speed 3;
		ACxx Status_ Fan Speed / 3 Speeds	1 byte	DPT_Enumerated	5.010		W	T	1 - Speed 1; 2 - Speed 2; 3 Speed 3;
	<b>41</b>	ACxx Status_ Fan Speed Manual/Auto	1 bit	DPT_Bool	1.002	R		T	0 – Manual; 1 - Auto
	<b>42</b>	ACxx Status_ Fan Speed 1	1 bit	DPT_Bool	1.002	R		T	1 – Fan is in speed 1
	<b>43</b>	ACxx Status_ Fan Speed 2	1 bit	DPT_Bool	1.002	R		T	1 – Fan is in speed 2
	<b>44</b>	ACxx Status_ Fan Speed 3	1 bit	DPT_Bool	1.002	R		T	1 - Fan is in Speed 3
	<b>45</b>	ACxx Status_ Fan Speed Text	14 byte	DPT_String_8859_1	16.001	R		T	ASCII String
<b>Vanes Up-Down</b>	<b>46</b>	ACxx Status_ Vanes U-D / 5 pos	1 byte	DPT_Scaling	5.001	R		T	20% - Pos1; 40% - Pos2; 60% - Pos3; 80% - Pos4; 100% – Pos5
		ACxx Status_ Vanes U-D / 5 pos	1 byte	DPT_Enumerated	5.010	R		T	1 - Pos1; 2 - Pos2; 3 - Pos3; 4 - Pos4; 5 – Pos5
	<b>47</b>	ACxx Status_ Vanes U-D Swing	1 bit	DPT_Bool	1.002	R		T	0 – Off; 1 - Swing

	<b>48</b>	ACxx Status_ Vanes U-D Pos1	1 bit	DPT_Bool	1.002	R		T	1 - Position 1
	<b>49</b>	ACxx Status_ Vanes U-D Pos2	1 bit	DPT_Bool	1.002	R		T	1 - Position 2
	<b>50</b>	ACxx Status_ Vanes U-D Pos3	1 bit	DPT_Bool	1.002	R		T	1 - Position 3
	<b>51</b>	ACxx Status_ Vanes U-D Pos4	1 bit	DPT_Bool	1.002	R		T	1 - Position 4
	<b>52</b>	ACxx Status_ Vanes U-D Pos5	1 bit	DPT_Bool	1.002	R		T	1 - Position 5
	<b>53</b>	ACxx Status_ Vanes U-D Text	14 byte	DPT_String_8859_1	16.001	R		T	ASCII String
<b>Temperature</b>	<b>54</b>	ACxx Status_ AC Setpoint Temp	2 byte	DPT_Value_Temp	9.001	R		T	(°C)
	<b>55</b>	ACxx Status_ AC Return Temp	2 byte	DPT_Value_Temp	9.001	R		T	(°C)
<b>Filter</b>	<b>56</b>	ACxx Status_ Filter Status	1 bit	DPT_Bool	1.002	R		T	0 - No Alarm; 1 - Alarm
<b>Lock</b>	<b>57</b>	ACxx Status_ Lock On/Off	1 bit	DPT_Bool	1.003		W	T	0 - Disabled; 1 - Enabled
	<b>58</b>	ACxx Status_ Lock Mode	1 bit	DPT_Start	1.003		W	T	0 - Disabled; 1 - Enabled
	<b>59</b>	ACxx Status_ Lock Set Temp	1 bit	DPT_Start	1.003		W	T	0 - Disabled; 1 - Enabled
<b>Error codes</b>	<b>60</b>	ACxx Status_ Error/Alarm	1 bit	DTP_Alarm	1.005	R		T	0 - No Alarm; 1 - Alarm
	<b>61</b>	ACxx Status_ Error Code	2 byte	Enumerated		R		T	0 - No Error; Any other see user's manual
	<b>62</b>	ACxx Status_ Error Text code	14 byte	DPT_String_8859_1	16.001	R		T	TO Error; Empty – none

**NOTE:** Object number is only referred to the first AC unit (AC01). In order to get the rest of the AC units object number for each communication object, please use the formula below:

$$\text{AC xx Object Number} = (\text{xx}-1)*62 + \text{current Object Number}$$