

TOSHIBA

OWNER'S MANUAL

R32 or R410A

INVERTER

ENGLISH

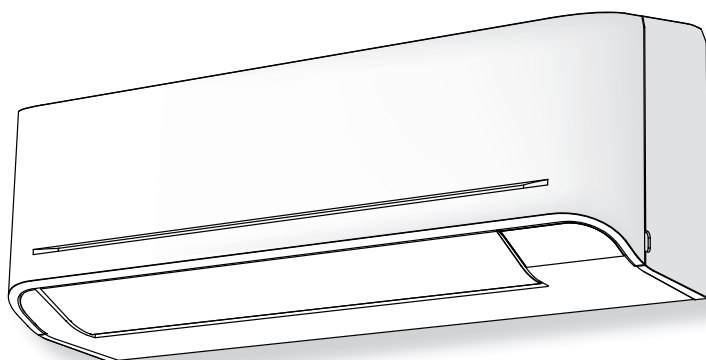

Scan QR CODE to access installation and owner's manual on website.

<https://www.toshiba-carrier.co.th/manuals/default.aspx>

Manual are available in AR/BG/CZ/DA/DE/EL/EN/ES/ET/FI/FR/HR/HU/IT/LT/LV/NL/NO/PL/PT/RO/RU/SK/SL/SV.



AIR CONDITIONER (SPLIT TYPE)

For general public use

Indoor unit

RAS-B05, 07, 10, 13, 16E2KVG-E

RAS-18, 24E2KVG-E

Outdoor unit

RAS-05, 07, 10, 13, 16, 18, 24E2AVG-E

1 INDOOR UNIT DISPLAY

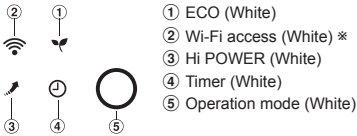

- ① ECO (White)
- ② Wi-Fi access (White) *
- ③ Hi POWER (White)
- ④ Timer (White)
- ⑤ Operation mode (White)

- Display brightness can be adjusted, follow procedure on ⑭.
- * Require Wireless LAN connecting adapter which available as accessory.

2 PREPARATION BEFORE USE

Preparing Filters

1. Open the air inlet grille and remove the air filters.
2. Attach the filters. (see detail in the Installation Manual).

Loading Batteries (when use wireless operation.)

1. Remove the slide cover.
2. Insert 2 new batteries (AAA type) following the (+) and (-) positions.

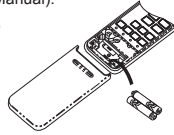

Clock Setup

1. Push **CLOCK** by tip of the pencil.
If timer indication is flashing, go to the next step 2.

2. Press **ON** or **OFF**: adjust the time.

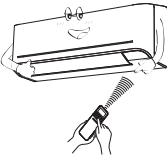

3. Press **SET**: Set the time.

Remote Control Reset

- Push **RESET** by tip of the pencil or
1. Remove the batteries.

2. Press **POWER**.
3. Insert the batteries.

3 AIR FLOW DIRECTION

1	Press FIX : Move the louver in the desired vertical direction.	
2	Press SWING : Swing the air automatically and press again to stop.	
3	For horizontal direction, adjust manually.	

- Note:**
- Do not move the louver manually by others.
 - The louver may automation positioning by some operation mode.

4 REMOTE CONTROL

- ① Infrared signal emitter
- ② Start/Stop button
- ③ Mode select button (MODE)
- ④ Temperature button (TEMP)
- ⑤ Fan speed button (FAN)
- ⑥ Swing louver button (SWING)
- ⑦ Set louver button (FIX)
- ⑧ 8°C Heating Operation (8°C)
- ⑨ On timer button (ON)
- ⑩ Off timer button (OFF)
- ⑪ Setup button (SET)
- ⑫ Clear button (CLR)
- ⑬ Memory and Preset button (PRESET)
- ⑭ Silent operation button (SILENT)
- ⑮ High power button (Hi POWER)
- ⑯ Eco button (ECO)
- ⑰ Quiet button (QUIET)
- ⑱ Comfort sleep button (COMFORT SLEEP)
- ⑲ Filter reset button (FILTER)
- ⑳ Set clock button (CLOCK)
- ㉑ Check button (CHECK)
- ㉒ Reset button (RESET)

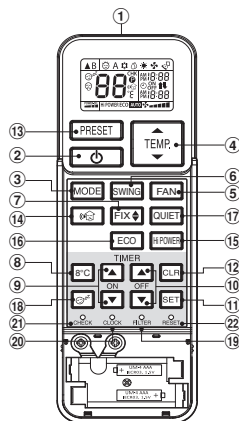

- Note:**
- The provided Remote Controller is a wireless type, which also can be used as a wire. Please see "How to Connect The Remote Controller for Wired Operation", located in installation instruction, in case of wired control is required.
 - In wire operation, remote controller will return to initial condition (PRESET, TIMER and CLOCK will return to initial condition) when user shutdown power supply of Air conditioner.

5 SILENT OPERATION

SILENT OPERATION

Keep outdoor unit operating silently to ensure either yourself or neighborhood will have a tight sleep in nighttime. By this feature, the heating capacity will be optimized to deliver such silent experience. The silent operation can be selected from one of two purposes (Silent 1 and Silent 2).

There are three setting parameters: Standard level > Silent 1 > Silent 2

Silent 1:

Though operating silently, the Heating (or Cooling) capacity is still prioritized to ensure having sufficient comfort inside the room.

This setting is a perfect balance between the Heating (or Cooling) capacity and the Sound level of outdoor unit.

Silent 2:

Compromising the Heating (or Cooling) capacity to the Sound level in any circumstance where the outdoor unit's sound level is highly prioritized.

This setting has a purpose to reduce the maximum sound level of outdoor unit by 4 dB(A).

Note:

- While activating of Silent operation, inadequate heating (or cooling) capacity may occur.

Silent Operation (Outdoor Unit)



6 AUTOMATIC OPERATION

To automatically select cooling, heating or fan only operation

1. Press **MODE**: Select Auto A.
2. Press **TEMP**: Set the desired temperature. Min. 17°C, Max. 30°C.
3. Press **FAN**: Select AUTO, LOW -, LOW+ -, MED -, MED+ - or HIGH -.

7 COOLING / HEATING / FAN ONLY OPERATION

1. Press **MODE**: Select Cool , Heat or Fan only .
2. Press **TEMP**: Set the desired temperature.
Min. 17°C, Max. 30°C.
Fan Only: No temperature indication
3. Press **FAN**: Select AUTO, LOW -, LOW+ -, MED -, MED+ - or HIGH -.

8 DRY OPERATION

For dehumidification, a moderate cooling performance is controlled automatically.

1. Press **MODE**: Select Dry .
2. Press **TEMP**: Set the desired temperature. Min. 17°C, Max. 30°C.

Note: Dry mode fan speed is set to Auto only.

9 Hi POWER OPERATION

To automatically control room temperature and airflow for faster cooling or heating operation (except in DRY and FAN ONLY mode)

Press **Hi POWER**: Start and stop the operation.

10 ECO OPERATION

To automatically control room temperature to save energy (except in DRY and FAN ONLY mode)

Press **ECO**: Start and stop the operation.

Note: Cooling operation; the set temperature will increase automatically 1 degree/hour for 2 hours (maximum 2 degrees increase).
For heating operation the set temperature will decrease.

11 8°C OPERATION

- Press button to change to 8°C set temperature heating operation.
- Press to adjust setting temperature from 5°C to 13°C.

Note: 8°C will operate in Heating mode only. If Air conditioner performs in cooling operation (including automatic cooling) or dry operation it will change to heating operating.

12 TEMPORARY OPERATION

In case of the misplaced or discharged remote control

- Pressing the RESET button, the unit can start or stop without using the remote control.
- Operation mode is set on AUTOMATIC operation, preset temperature is 24°C and fan operation is automatic speed.

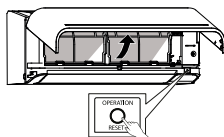

OPERATION /
RESET Button

13 TIMER OPERATION

Set the timer when the air conditioner is operating.

	Setting the ON Timer	Setting the OFF Timer
1	Press : Set the desired ON timer.	Press : Set the desired OFF timer.
2	Press : Set the timer.	Press : Set the timer.
3	Press : Cancel the timer.	Press : Cancel the timer.

Daily timer allows the user to set both the ON & OFF timers and will be activated on a daily basis.

Setting Daily Timer

1	Press : Set the ON timer.	3	Press :
2	Press : Set the OFF timer.	4	Press button during the (I or I) mark flashing.

- During the daily timer is activating, both arrows (I, I) are indicated.

Note:

- Keep the remote control in accessible transmission to the indoor unit; otherwise, the time lag of up to 15 minutes will occur.
- The setting will be saved for the next same operation.

14 DISPLAY LAMP BRIGHTNESS ADJUSTMENT

To decrease the display lamp brightness or turn it off.

- Press and hold for 3 seconds until brightness level (d0, d1, d2 or d3) is shown on remote control LCD then release the button.
- Press Rise or Decrease to adjust brightness in 4 levels.

Remote control LCD	Operation display	Brightness
d3	Lamp illuminates full brightness.	100%
d2	Lamp illuminates 50% brightness.	50%
d1	Lamp illuminates 50% brightness and the operation lamp is turned off.	50%
d0	All lamps are turned off.	All turned off

- In the examples of d1 and d0, the lamp illuminates for 5 seconds before going off.

15 PRESET OPERATION

Set your preferred operation for future use. The setting will be memorized by the unit for future operation (except airflow direction).

- Select your preferred operation.
- Press and hold for 3 seconds to memorize the setting. The P mark displays.
- Press : Operate the preset operation.

16 AUTO RESTART FUNCTION SETTING

This product is designed so that, after a power failure, it can restart automatically in the same operating mode as before the power failure.

Information

The product is shipped with Auto Restart function in the ON position. Turn it OFF if this function is not required.

How to turn OFF the Auto Restart Function

- Press and hold the [OPERATION] button on the indoor unit for 3 seconds (3 beep sounds but OPERATION lamp does not blink).

How to turn ON the Auto Restart Function

- Press and hold the [OPERATION] button on the indoor unit for 3 seconds (3 beep sounds and OPERATION lamp blink 5 time/sec for 5 seconds).

Note:

- In case of ON timer or OFF timer are set, AUTO RESTART OPERATION does not activate.

17 QUIET OPERATION

To operate at super low fan speed for quiet operation (except in DRY mode)

Press : Start and stop the operation.

Note: Under certain conditions, QUIET operation may not provide adequate cooling due to low sound features.

18 COMFORT SLEEP OPERATION

For comfortable sleep, automatically control air flow and automatically turn OFF.

Press : Select 1, 3, 5 or 9 hrs for OFF timer operation.

Note: The cooling operation, the set temperature will increase automatically 1 degree/hour for 2 hours (maximum 2 degrees increase). For heating operation, the set temperature will decrease.

19 MAINTENANCE

Firstly, turn off the circuit breaker.

Indoor Unit and Remote Control

- Clean the indoor unit and the remote control with a wet cloth when needed.
- No benzine, thinner, polishing powder or chemically-treated duster.

Air filters

Clean every 2 weeks.

- Open the air inlet grille.
- Remove the air filters.
- Vacuum or wash and then dry them.
- Reinstall the air filters and close the air inlet grille.

20 SELF CLEANING OPERATION (COOL AND DRY OPERATION ONLY)

To protect bad smell caused by the humidity in the indoor unit.

- If the button is pressed once during "Cool" or "Dry" mode, the fan will continue to run for other 30 minutes, then it will turn off automatically. This will reduce the moisture in the indoor unit.
- To stop the unit immediately, press the more 2 times within 30 seconds.

21 MANUAL DEFROST OPERATION

To defrosting the heat exchanger of the outdoor unit during Heating operation.

Press and hold  **SET** : for 5 sec. then remote control display will show [dF] as picture ① for 2 sec.

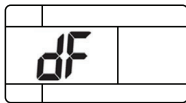

①

22 OPERATION AND PERFORMANCE

1. Three-minute protection feature: To prevent the unit from being activated for 3 minutes when suddenly restarted or switched to ON.
2. Preheating operation: Warm up the unit for 5 minutes before the heating operation starts.
3. Warm air control: When the room temperature reaches the set temperature, the fan speed is automatically reduced and the outdoor unit will stop.
4. Automatic defrosting: Fans will stop during defrost operation.
5. Heating capacity: Heat is absorbed from outdoors and released into the room. When the outdoor temperature is too low, use another recommended heating apparatus in combination with the air conditioner.
6. Consideration for accumulated snow: Select the position for outdoor unit where it will not be subjected to snow drifts, accumulation of leaves or other seasonal debris.
7. Some minor cracking sound may occur when unit operating. This is normal because the cracking sound may be caused by expansion/contraction of plastic.

Note: Item 2 to 6 for Heating model

Air conditioner operating conditions

Operation	Temp.	Outdoor Temperature	Room Temperature
Heating		-15°C ~ 24°C	Less than 28°C
Cooling		-15°C ~ 46°C	21°C ~ 32°C
Dry		-15°C ~ 46°C	17°C ~ 32°C



23 TROUBLESHOOTING (CHECK POINT)

The unit does not operate.	Cooling or Heating is abnormally low.
<ul style="list-style-type: none"> • The power main switch is turned off. • The circuit breaker is activated to cut off the power supply. • Stoppage of electric current • ON timer is set. 	<ul style="list-style-type: none"> • The filters are blocked with dust. • The temperature has been set improperly. • The windows or doors are opened. • The air inlet or outlet of the outdoor unit is blocked. • The fan speed is too low. • The operation mode is FAN or DRY • POWER SELECTION function is set 75% or 50% (This function is depend on remote controller).

24 REMOTE CONTROL A-B SELECTION

To separate using of remote control for each indoor unit in case of 2 air conditioners are installed nearby.

Remote Control B Setup.

1. Press RESET button on the indoor unit to turn the air conditioner ON.
2. Point the remote control at the indoor unit.
3. Push and hold  **CHECK** button on the Remote Control by the tip of the pencil. "00" will be shown on the display. (Picture ①)
4. Press  **MODE** during pushing  **CHECK**. "B" will show on the display and "00" will disappear and the air conditioner will turn OFF. The Remote Control B is memorized. (Picture ②)

- Note:**
1. Repeat above step to reset Remote Control to be A.
 2. Remote Control A has not "A" display.
 3. Default setting of Remote Control from factory is A.

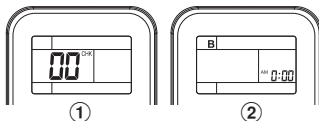

①

②

TOSHIBA