

For commercial use

Model name:

RBC-AWSU52-E

RBC-AMSU52-E

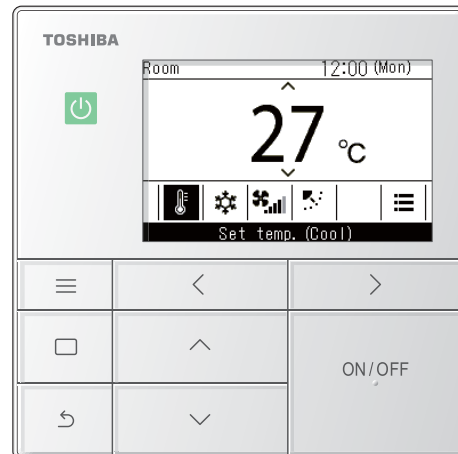

- Refer to this manual when using an RBC-AWSU52-E, RBC-AMSU52-E remote controller.
- Refer to the Owner's Manual, which is provided with the air conditioner, for information not related to operating the remote controller.

- Please read through the Owner's Manual carefully and ensure that you understand it before using the air conditioner, so that you can use the product safely and correctly.
- After reading this manual, keep it available to all users for future reference. If the user changes, be sure to give this manual to the new user.

Multilingual installation manuals and owner's manual



[Български] Изтегляне на Ръководство за монтаж и Ръководство на потребителя / [Česky] Stažení Instalační příručky a Uživatelské příručky / [Dansk] Download af installationsvejledning og brugervejledning / [Deutsch] Installationshandbuch und Bedienungsanleitung herunterladen / [Ελληνικά] Λήψη εγχειριδίου εγκατάστασης και εγχειριδίου κατόχου / [English] Installation manual and Owner's manual Download / [Español] Descarga del Manual de instalación y del Manual del propietario / [Eesti] Paigaldusjuhendi ja kasutusjuhendi allalaadimine / [Suomi] Asennusohjeiden ja käyttöohjeiden lataaminen / [Français] Téléchargement du manuel d'installation et du manuel du propriétaire / [Hrvatski] Preuzimanje Instalacijskog priručnika i Vlasničkog priručnika. / [Magyar] Telepítési kézikönyv és Felhasználói kézikönyv letöltése / [Italiano] Download del Manuale di installazione e del Manuale dell'utilizzatore / [한국어] 설치 설명서 및 사용자 설명서 다운로드 / [Latviešu] Uzstādīšanas rokasgrāmatas un lietotāja rokasgrāmatas lejupielāde / [Norsk] Nedlasting av installasjonsveiledning og bruksanvisning / [Nederlands] Installatiehandleiding en Handleiding downloaden / [Polski] Pobieranie Instrukcji instalacyjnej oraz Instrukcji użytkownika / [Português] Download do Manual de instalação e Manual do Proprietário / [Română] Descărcarea Manualului de instalare și a Manualului proprietarului / [Русский] Скачать Руководство по установке и Руководство пользователя / [Slovensky] Stiahnutie Montážnej príručky a Uživatelskej príručky / [Slovenščina] Prenos navodil za montažo in navodil za uporabo / [Svenska] Nedladdning av installationshandbok och bruksanvisning / [Türkçe] Kurulum kılavuzu ve Kullanıcı kılavuzu İndirme / [中文] 安装手册和用户手册下载

<https://www.toshiba-carrier.co.jp/global/manual/rbc-amsu52-e.htm>

English

Contents





1	Safety precautions	4
2	Description of terminology	5
3	Before use	6
4	Part names and functions	6
5	Basic operations	11
	Air conditioner	11
	Operations	11
	Changing the set temperature	11
	Changing the operation mode	12
	Changing the fan speed	12
	Changing the wind direction	13
	Air to Air Heat Exchanger	15
	Adjusting fan speed	15
	Ventilation mode settings	16
	Humidification setting	16
	Ventilation menu	16
6	Practical operations	17
	How to operate menus	17
	Menu list	18
	1. Individual louver (Select wind direction for each air outlet)	20
	2. Louver setting (Selecting the type of swing or fixing the louvres) . . .	21
	Swing type	21
	Louver lock (Fixing the angle of the louvres)	22
	3. Timer (Setting a timer to start or stop operation)	23
	Selecting a timer type	23
	Off timer	24
	On timer	25
	Off reminder timer	26
	4. Schedule timer	
	(Setting 1-day operation schedule to do operations)	27
	Setting the schedule timer to ON	28
	Condition setting (Setting 1-day operation schedules)	29
	Holiday setting (Days to not operate to a schedule timer)	33
	Pre-HEX operation	33
	5. Night operation (Reducing operating noise of outdoor units)	34

6. Filter sign reset	35
When the filter check mark is displayed (filter check reset)	35
When the filter check mark is not displayed (the time remaining until a filter check is displayed)	36
7. Auto grille	37
8. Energy saving	38
Energy saving operation	39
Set temp. range limit	41
Return back	42
Saving operation	43
9. Monitor	44
10. Initial setting	45
Clock	46
Screen contrast	46
Light & LED	47
Sound	47
Key lock (Select operations to lock)	48
11. Ventilation	49
Ventilation operation (ON or OFF for ventilation)	49
Fan speed	50
Mode	50
24h ventilation off	50
Schedule timer	51
12. Soft Cooling	52
13. Occupancy sensor	53
14. Power consumption	54
15. Information	55
Checking the Model information	55
When central control is done	55
Other	56
Individual temperature settings for “Cool” and “Heat” in auto operation modes (dual set point)	56
When multiple indoor units are connected as a group (group connection)	57
Link and operate the Air purifier function of indoor units	58
Silent mode(IDU)	58
Low temp. Dry	58
Lock operations (operation lock)	59
Self clean operation	59

7	Maintenance	60
	Daily	60
	Cleaning the filters	60
8	Troubleshooting	61
	Confirm and check	61
	Contact information for repairs	61

1 Safety precautions

- This section describes safety measures to prevent harm to users and other people, and damage to property.
- The "Explanation of indications" explains the categories of levels of danger and harm that could occur if handling is done incorrectly and the "Explanation of symbols" gives the meaning of the symbols.

Explanation of indications		Explanation of symbols	
 WARNING	This indicates that failure to adhere to the directions in the warnings could result in serious bodily harm (*1) or loss of life if the product is handled improperly.		The ⊘ sign indicates a prohibited action. The specific prohibited action is indicated by a pictograph or warning text placed inside or next to the symbol.
 CAUTION	This indicates that failure to adhere to the directions in the caution could result in serious bodily injury (*2) or damage to property (*3) if the product is handled improperly.		This ● sign indicates a mandatory action, an action that must be performed. The actual contents of the instructions are indicated by a picture or text placed inside or next to the symbol.
<p>*1: Serious bodily harm indicates loss of eyesight, injury, burns, electric shock, bone fracture, poisoning, and other injuries which leave after effects and injuries which require hospitalization or long-term treatment as an outpatient.</p> <p>*2: Moderate injury indicates injury, burns, electric shock, and other injuries which do not require hospitalization or long-term treatment as an outpatient.</p> <p>*3: Damage to property indicates damage extending to buildings, household effects, domestic livestock, or pets.</p>			The pictograph inside △ and nearby text indicates additional information about cautions.

WARNING

Warnings for installation



Request installation

- **Ask your original dealer or a professional for installation work**

Installation requires specialised technical expertise.

Attempting to carry out installation on your own and doing so incorrectly may lead to fire, electric shock, injury or water leakage.



Use dedicated products

- **Use only products specified by Toshiba Carrier**

Use only products specified by Toshiba Carrier for options. Use of other non-specified products may result in fire, electric shock, or water leakage.

Have a specialist do the installation.

Warnings about operations



Turn off the power

- **If a problem occurs (such as a burning smell), stop operation, turn off the power switch and contact your original retailer**

Continuing operation while the problem remains may cause fire, electric shock or malfunction.

CAUTION

Operating precautions



Prohibited

- **Do not operate the switches with wet hands**

Doing so may result in electric shock.



Turn off the power

- **Before cleaning the unit, stop operation and turn off the power**

The internal fans rotate very fast and may cause an injury.

2 Description of terminology

Terminology	Description
Energy saving operation	Operates air conditioners with suppressed performance to save energy.
Saving operation	Operates to save energy by automatically correcting set temperature within a range so there is no great loss of comfort.
Soft Cooling	Operates to reduce the sense of draughtiness (feeling of being too cool) when "Cool" is set by correcting louvre angle and suppressing performance.
Set temp. range limit	This function limits the range of temperatures that can be set by the remote controller.
Return back	If the temperature setting is ever changed, this function returns it to the previously set temperature after a certain amount of time has elapsed.
Dual set point	This function sets individual temperature settings for "Cool" and "Heat" when "Auto" operation is set.
Group connection	A method of connecting multiple indoor units, as 1 group, to the same remote controller.
Header remote controller, Follower remote controller	To use 2 remote controllers for 1 indoor unit (or 1 group), so that one of the remote controllers is set as the "Header remote controller" and the other as the "Follower remote controller". Set to "Header remote controller": Able to operate all functions. Set to "Follower remote controller": Cannot operate some functions. (For the functions that cannot be operated, refer to the Installation Manual.)
Night operation	This setting reduces the operating noise of the outdoor units.
Auto grille	Intake grille of indoor unit that be automatically raised or lowered by operations on the remote controller, such as when cleaning the filter.
Air purifier	This is an air purifier function that is built-in to the indoor unit or can be bought separately and added.
Self clean operation	This function does "Fan" operation after "Cool" and "Dry" operations to keep the inside of the indoor unit dry and clean.
Air to Air Heat Exchanger	Ventilation unit (product) that has an air-to-air heat exchange function (functions to reduce loss of cold air or warm air due to ventilation by exchanging heat at suction and exhaust.).
Heat exchange	This is ventilation done by heat exchange.
Nighttime heat purge	This function exhausts heat that is inside a room, after "Cool" operation is stopped, to the outside.

3 Before use

When you use the air conditioner for the first time or change the settings, follow the procedures below. From the next time, just press [ON/OFF ON/OFF] to start operating according to the settings.

Preparation

Turn on the power breaker

When the power is turned on, “⏸” appears on the remote controller display.

* The remote controller will not work for about 3 minutes after turning on the power. This is not a malfunction.

REQUIREMENT

- Keep the power breaker turned on during use.
- When you resume using the air conditioner after a long period of disuse, turn on the power breaker at least 12 hours before starting operation.

4 Part names and functions

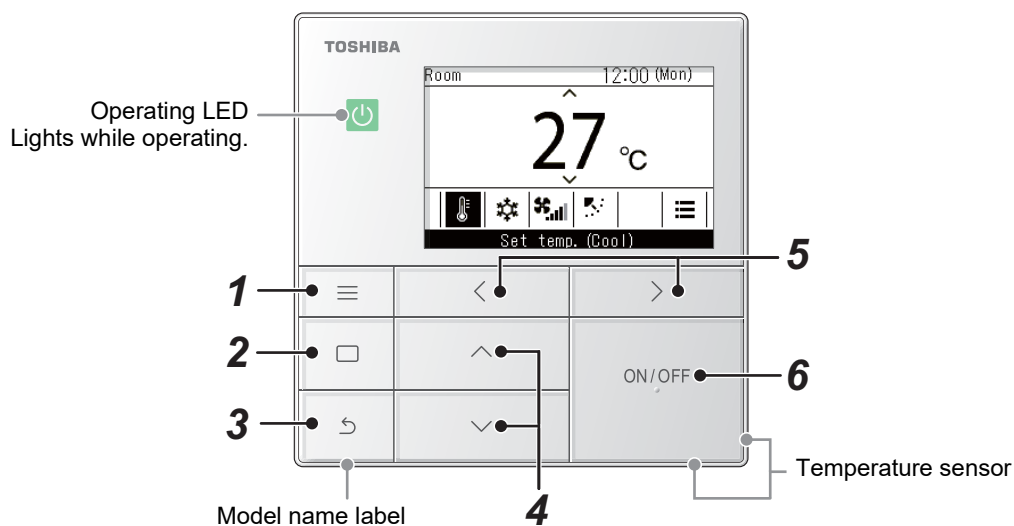

* The screens shown here are examples. The content that is displayed may differ, depending on the environment settings being used.

1 [≡ Menu] button

Shows the "Menu".
(Page 17)

2 [□ Set/Fix] button

Fixes and applies settings.
Ways to use it are shown on screen.

3 [↶ Return] button

Deletes selections.
Ways to use it are shown on screen.

4 [▲] and [▼] buttons

Changes settings and selects items.

5 [◀] and [▶] buttons

Selects setting items.
Other ways to use it are shown on screen.

6 [ON/OFF ON/OFF] button

Starts and stops connected devices.

■ Main screen types and configuration

- When connected to an air conditioner, the main screen of the air conditioner is displayed, and when connected to an Air to Air Heat Exchanger, the main screen of the Air to Air Heat Exchanger is display on screen.
- When connected to both air conditioners and Air to Air Heat Exchangers, you can switch screens by pressing [<] or [>] in either of the main screens.

Air conditioner main screen

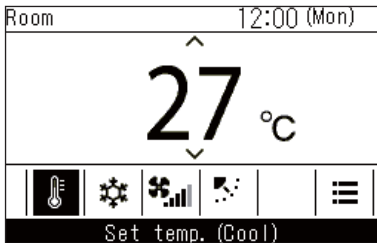

Press the [<] or [>] button.

Air to Air Heat Exchanger main screen

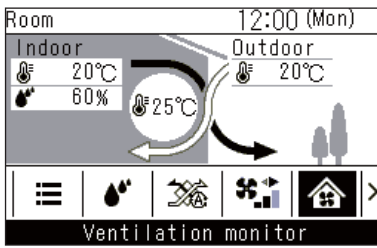

■ Air conditioner main screen

This screen is for confirming or changing settings that are used every day, such as temperature, operating mode, fan speed and wind direction.

You can check the current state according to the setting items on the bottom of the screen.

You can switch the setting items by pressing [<] and [>], and change them by pressing [^] and [v].

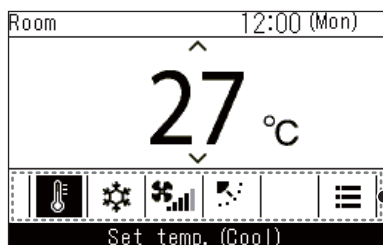

Setting items

- The currently selected item is highlighted in black.
- You can switch the items by pressing [<] and [>].

NOTE

- The temperature setting is changed in the main screen.
- Functions and items that cannot be set are not shown, according to the model.
- While changing settings, if you press [↵ Return] or if there are no button operations for about 60 seconds, the main screen returns.

Switching between the detailed display and simple display (air conditioner main screen only)

You can change the main screen to the simple display, depending on the “Display mode” setting. For details on changing “Display mode”, refer to “Display setting” in “Initial setting” in the Installation Manual.

The detailed display is set as the factory default setting.

Detailed display (factory default setting)

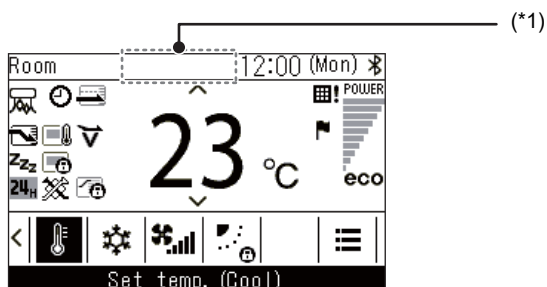

Simple display

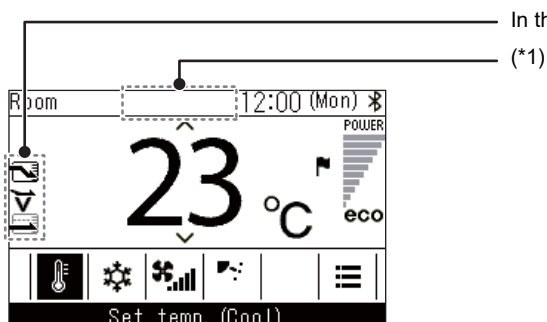

In the simple display, only some icons are shown.

- *1: Preparing to heat
Displayed when “Heat” operation starts or when the defrost cycle is operating. While the icon is displayed, the indoor fan stops or the “Fan” turns on.
- Preparing to operate
This may be displayed on some models.
- Preparing to operate ventilation
Displayed while the air to air heat exchanger is on standby. While this is being displayed, the air to air heat exchanger remains stopped.

■ Air to Air Heat Exchanger main screen

Displayed when Air to Air Heat Exchangers are connected. This screen is for monitoring the state of the air and for setting the ventilation fan speed and ventilation mode.

You can check the current state according to the setting items on the bottom of the screen.

You can switch the setting items by pressing [<] and [>], and change them by pressing [^] and [v].

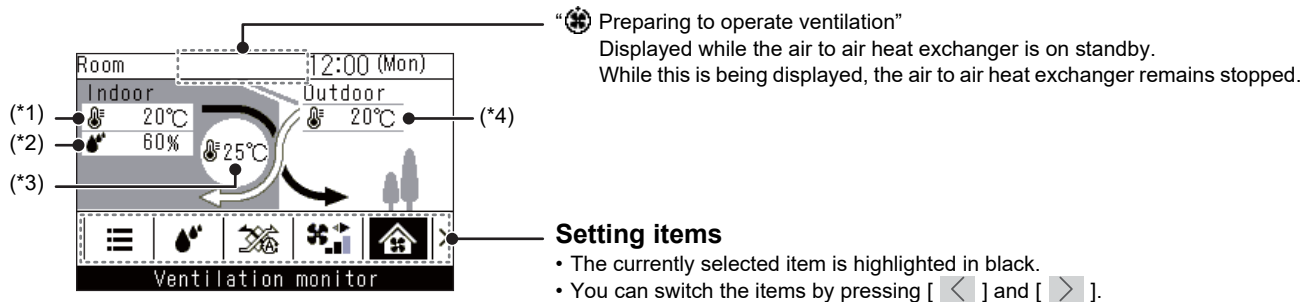

- *1: Indoor temperature
- *2: Indoor humidity
- *3: Supply air temperature
- *4: Outdoor temperature

NOTE

- The "Ventilation monitor" screen is the main screen.
- Functions and items that cannot be set are not shown, according to the model.
- While changing settings, if you press [Return] or if there are no button operations for about 60 seconds, the main screen returns.

■ Icon list

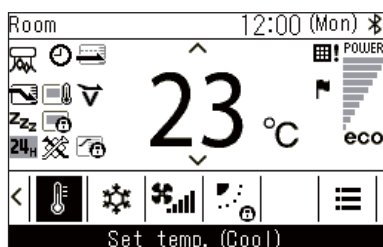

▼ Air conditioner

	Displayed when "Energy saving operation" is "ON". (Page 39)		Displayed when "Timer" is "ON". (Page 23, 27)
	Displayed when remote controller sensor is set. (*1)		Displayed when "Louver lock" is set. (Page 22)
	Displayed when "Night operation" is "ON". (Page 34)		Displayed when it is time for filter maintenance. (Page 35, 60)
	Displayed when operations are locked by central control. (*1) (Page 55)		Displayed when "Soft Cooling" operation is "ON". (Page 50)
	Displayed when "Saving operation" is "ON". (Page 43)		Displayed for about 3 seconds when the operation mode is changed in the "Mode" screen when the operation mode is restricted.
	Displayed when the Bluetooth® function is "ON". Refer to the Owner's Manual of the Bluetooth® function regarding Bluetooth® functions.		Displayed when "Air purifier" function is "ON". (Page 58)
	Displayed when a check code occurs. (*1)		Displayed when a notice code occurs. (*1) For details, contact your dealer.
	It reaches the set temperature, and displayed while the room temperature is maintained.		It is displayed when a commercially available ventilation unit connected to the air conditioner is in operation.

*1: Refer to the Installation Manual of the Wired remote controller.

▼ Air to Air Heat Exchanger

- Displayed only when Air to Air Heat Exchangers are connected.
- For details on the ventilation function, refer to the Owner's Manual of the Air to Air Heat Exchanger.

	Automatic		24-hour ventilation
	Bypass		Nighttime heat purge
	Heat exchange		

5 Basic operations

Air conditioner

■ Operations

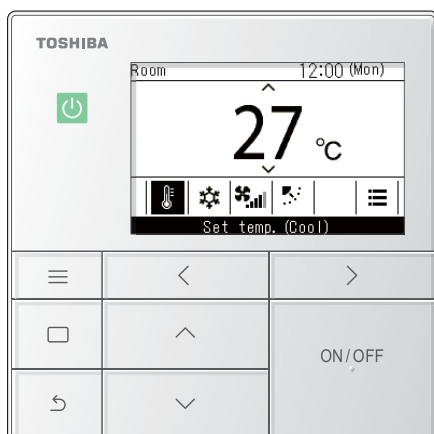

- 1** Press [**ON/OFF** ON/OFF] to start operations
→ The operation LED lights.
- 2** Press [**<**] and [**>**] to select the item you want to change
→ You can change the following items.
Setting temperatures (Page 11)
Operation mode (Page 12)
Fan speed (Page 12)
Wind direction (Page 13)
- 3** To stop operations, press [**ON/OFF** ON/OFF] again

■ Changing the set temperature

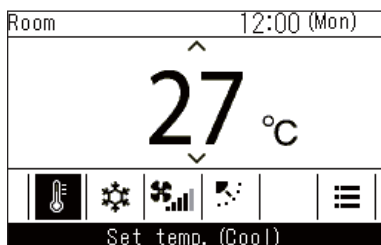

- 1** Press [**<**] and [**>**] to switch to the “Set temp.” screen
- 2** Press [**▲**] and [**▼**] to change the temperature setting
→ Press [**▲**] to increase and press [**▼**] to decrease the set temperature.

NOTE

- For the range of temperatures that can be set, refer to <Set temp. range limit>. (Page 41)
- The temperature setting cannot be changed when “Fan” is set.
- If the operation mode is set to “Auto” and dual set point is set, refer to <Individual temperature settings for “Cool” and “Heat” in auto operation modes (dual set point)>. (Page 56)

■ Changing the operation mode

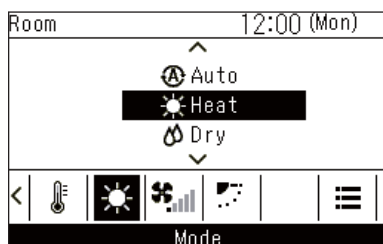

- 1 Press [<] and [>] to switch to the "Mode" screen
- 2 Press [^] and [v] to select an operation mode

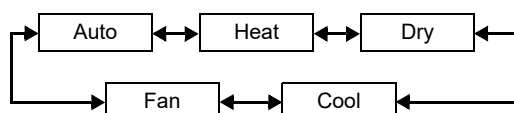

NOTE

Operation modes that cannot be set are not shown, according to the model of indoor unit.

■ Changing the fan speed

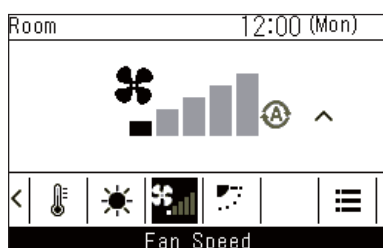
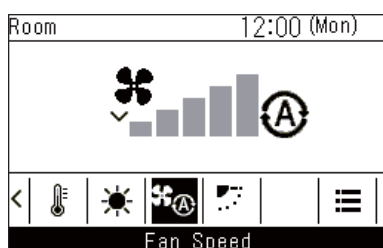

- 1 Press [<] and [>] to switch to the "Fan Speed" screen
- 2 Press [^] and [v] to select fan speed

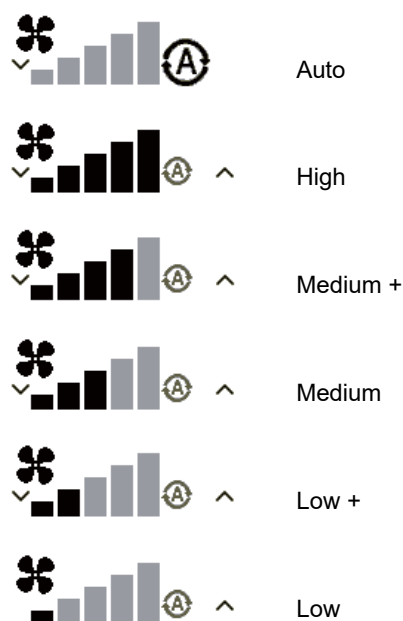

NOTE

- When the operation mode is "Fan", you cannot select "Auto".
- The fan speed that can be set varies depending on the indoor unit connected.
- "A" is displayed when combined with an indoor unit that cannot do "Fan Speed".

■ Changing the wind direction

- If the connected indoor units have louvres, then the horizontal louvre icon is displayed on the air conditioner main screen.
- If the connected indoor units have vertical louvres, then the vertical louvre icon is displayed on the air conditioner main screen.
- * For models that have only left-right directional louvres, they are operated as horizontal louvres on the remote controller.

Up / down direction: Horizontal louvres

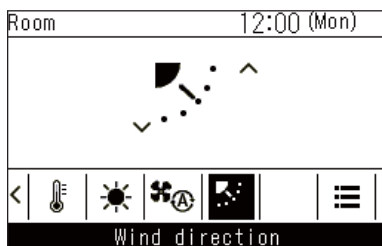

* Display while swinging

- 1 Press [<] and [>] to switch to the “Wind direction” screen (horizontal louvres)
- 2 Press [^] and [v] to select wind direction

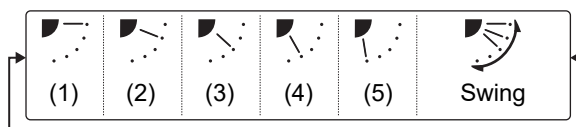

Operation mode	Settable angles
Heat, Fan, Auto (Heat)	(1), (2), (3), (4), (5), Swing
Cool, Dry, Auto (Cool)	(1), (2), (3), Swing

Left / right direction: Vertical louvres



* Display while swinging

- 1 Press [<] and [>] to switch to the “Wind direction” screen (vertical louvres)
- 2 Press [^] and [v] to select wind direction

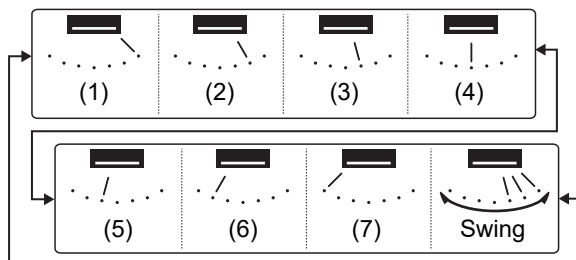

cancelling swing

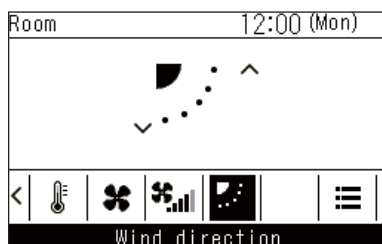

* Display when swinging (up / down) is cancelled
“Fan”, “Heat”



* Display when swinging (up / down) is cancelled
“Cool”, “Dry”

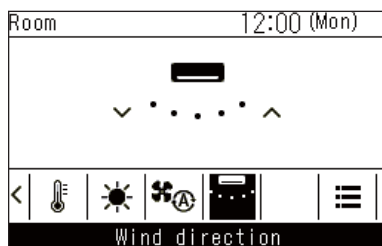

* Display when swinging (left / right) is cancelled

1 During swing operation, press [<] and [>] to switch to the “Wind direction” screen

2 Press [^] or [v]

→ The louvres stop at the position when [^] or [v] is pressed.

→ When [v] is pressed in the display when swing was cancelled, the louvres go to wind direction position (1), when [^] is pressed, the louvres go to position (3) during “Cool” or “Dry” operation, and go to position (5) during “Fan” or “Heat” operation, and vertical louvres go to position (7).

NOTE

- When the operation mode is “Cool” or “Dry”, the horizontal louvres point downward but do not stop at positions (4) or (5). If swing is stopped in positions (4) or (5), the louvres move to position (3) and then stop.
- “” is displayed when “Louver lock” is set. (Page 22)

Air to Air Heat Exchanger

■ Adjusting fan speed

NOTE

The factory default setting for fan speed unbalance ("Supply air > Exhaust air" or "Supply air < Exhaust air") is disabled. Disabled setting items are not shown. To enable it, contact your supplier (dealer).

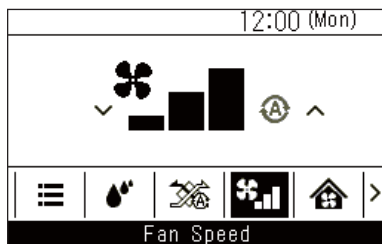

1 Press [<] and [>] to switch to the "Fan speed" screen

2 Press [^] and [v] to select ventilation fan speed

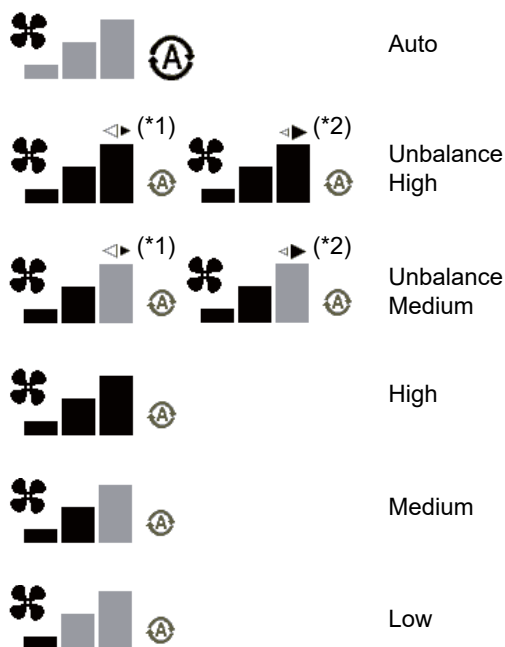

- *1: ◀▶ When "Supply air > Exhaust air" is set
The volume of supply air to the inside is larger than the volume of exhaust air to the outside.
- *2: ▶▶ When "Supply air < Exhaust air" is set
The volume of exhaust air to the outside is larger than the volume of supply air to the inside.

■ Ventilation mode settings

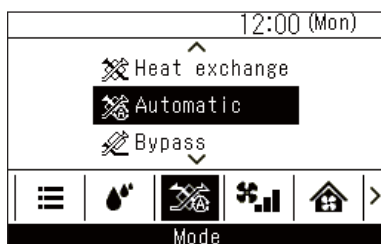

- 1 Press [<] and [>] to switch to the “Mode” screen
- 2 Press [^] and [v] to select a ventilation mode

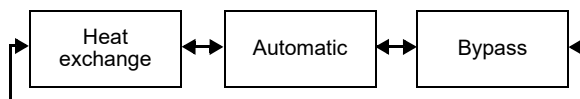

■ Humidification setting



- 1 Press [<] and [>] to switch to the “Humidification” screen
- 2 Press [^] and [v] to select “Auto” or “OFF”

■ Ventilation menu

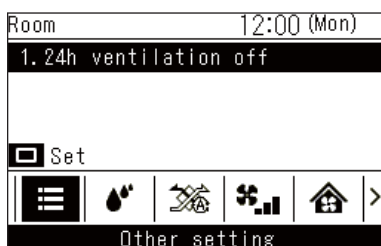





- 1 Press [<] and [>] to switch to the menu function setting screen
- 2 Press [^] and [v] to select menu functions
- 3 Press [Set/Fix]
→ A screen to confirm appears.
- 4 Press [Set/Fix]
→ Return to the menu function setting screen.

6 Practical operations

How to operate menus



- 1** Press [ Menu]
 - 2** Press [] and [] to select an item
→ The selected item is highlighted in black.
 - 3** Press [ Return]
 - 4** Press [ Return]
- Return to the main screen.

■ Menu list

Menu		
1. Individual louver	(Page 20)
2. Louver setting	(Page 21)
1. Swing type	(Page 21)
2. Louver lock	(Page 22)
3. Timer	(Page 23)
1. Off timer	(Page 24)
2. On timer	(Page 25)
3. Off reminder timer	(Page 26)
4. Schedule timer	(Page 27)
1. Schedule timer	(Page 28)
2. Condition setting	(Page 29)
3. Holiday setting	(Page 33)
4. Pre-HEX operation	(Page 33)
5. Night operation	(Page 34)
6. Filter sign reset	(Page 35)
7. Auto grille	(Page 37)
8. Energy saving	(Page 38)
9. Monitor	(Page 44)
10. Initial setting	(Page 45)
1. Clock	(Page 46)
2. Name of room Refer to the Installation Manual of the Wired remote controller.	
3. Display setting Refer to the Installation Manual of the Wired remote controller.	
4. Screen contrast	(Page 46)
5. Light & LED	(Page 47)
6. Sound	(Page 47)

→	10. Initial setting (continued) (Page 45)
	→	7. Key lock (Page 48)
	→	8. Password setting Refer to the Installation Manual of the Wired remote controller.
	→	9. Header/Follower Refer to the Installation Manual of the Wired remote controller.
	→	10. Language Refer to the Installation Manual of the Wired remote controller.
	→	11. Press & hold 4 sec. Refer to the Installation Manual of the Wired remote controller.
	→	12. Summer time Refer to the Installation Manual of the Wired remote controller.
	→	13. Clock synchronisation Refer to the Installation Manual of the Wired remote controller.
	→	14. Bluetooth Refer to the Owner's Manual of the Bluetooth® function.
→	11. Ventilation (Page 49)
	→	1. Ventilation operation (Page 49)
	→	2. Fan speed (Page 50)
	→	3. Mode (Page 50)
	→	4. 24h ventilation off (Page 50)
	→	5. Schedule timer (Page 51)
→	12. Soft Cooling (Page 52)
→	13. Occupancy sensor (Page 53)
→	14. Power consumption (Page 54)
→	15. Information (Page 55)
	→	Model information (Page 55)
	→	Service information (Page 61)

■ 1. Individual louver (Select wind direction for each air outlet)

You can set the wind direction for each outlet of indoor units that have 4-way air discharge.

NOTE

- This function may not be available, depending on the model of the indoor unit.
- This function can only be set while the air conditioner is operating.

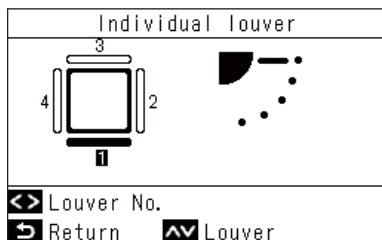

1 In "Menu" (Page 17), select "Individual louver", and press []

2 Press [] and [] to select louvres

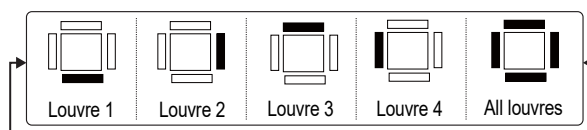

3 Press [] and [] to select wind direction

→ For details, refer to <Changing the wind direction>. (Page 13)

4 Press []

→ Return to "Menu".

▼ 4-way air discharge type

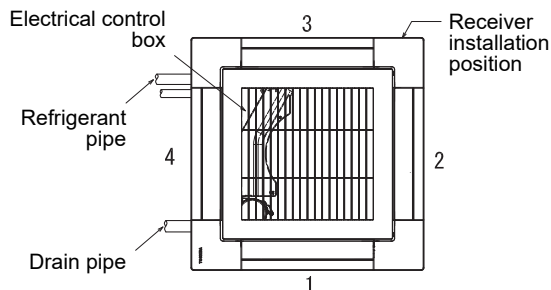

▼ Compact 4-way air discharge type

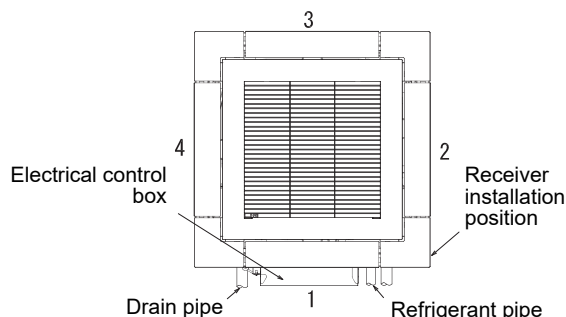

NOTE

- For models that "Individual louver" is not available, the message "No function" is displayed.
- Press [] or [] while swinging to stop the louvre and cancel swinging, press [] or [] again to select an wind direction.
- For group connections, refer to <When multiple indoor units are connected as a group (group connection)>. (Page 57)
- "🔒" is displayed when "Louver lock" is set. That louvre cannot do "Individual louver". (Page 22)

2. Louver setting (Selecting the type of swing or fixing the louvres)

NOTE

This function may not be available, depending on the model of the indoor unit.

Swing type

You can select from 3 types of swing operation: "Standard", "Dual", or "Cycle".

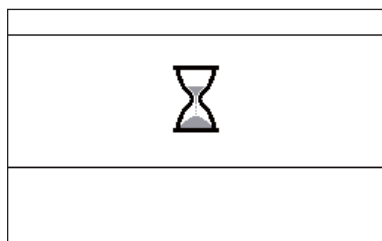
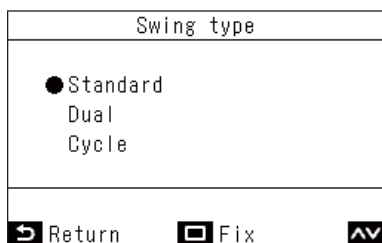
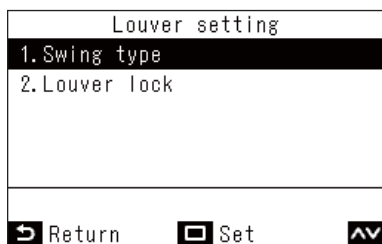

- 1** In "Menu" (Page 17), select "Louver setting", and press [Set/Fix]
- 2** Press [] and [] to select "Swing type", and then press [Set/Fix]
- 3** In the "Swing type" screen, press [] and [] to select a mode
→ Regarding "Swing type", refer to the Owner's Manual of the indoor unit.
- 4** Press [Set/Fix]
→ Return to the "Louver setting" screen.
- 5** Press [Return]
→ "⌚" is displayed.
→ When doing group connections, the screen for selecting units is displayed, so press [Return] to display "⌚".

NOTE

- For models that "Louver setting" is not available, the message "No function" is displayed.
- Press [Return] to not fix the changes, so conditions are as before changes, and return to the "Louver setting" screen.
- For group connections, refer to <When multiple indoor units are connected as a group (group connection)>. (Page 57)

Louver lock (Fixing the angle of the louvres)

You can set and fix the angle of louvres individually for each air outlet.

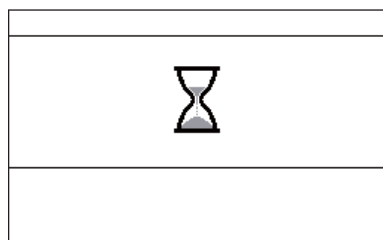
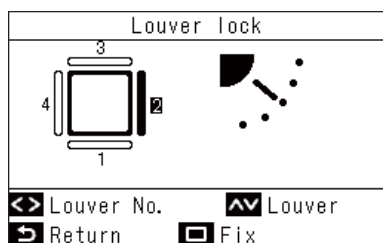
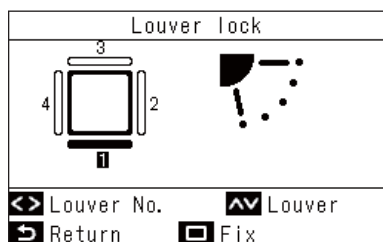
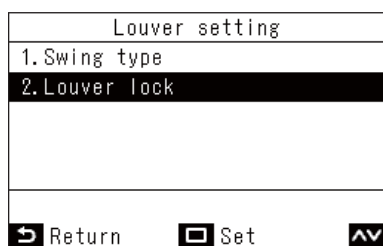

- 1** In “Menu” (Page 17), select “Louver setting”, and press [Set/Fix]
- 2** Press [] and [] to select “Louver lock”, and then press [Set/Fix]
- 3** Press [] and [] to select louvres

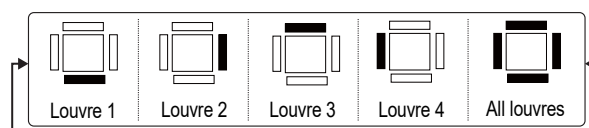

→ For louver numbers of each indoor unit, refer to <Individual louver (Select wind direction for each air outlet)>. (Page 20)

- 4** Press [] and [] to select a louver angle (wind direction)

→ Press [] to raise a louver and press [] to lower a louver.

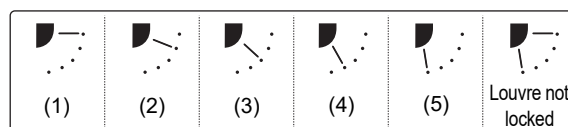

- 5** Press [Set/Fix]
- Return to the “Louver setting” screen.

- 6** Press [Return]

→ “⌚” is displayed.

→ When doing group connections, the screen for selecting units is displayed, so press [Return] to display “⌚”.





NOTE

- For models that “Louver setting” is not available, the message “No function” is displayed.
- Press [Return] to not fix the changes, so conditions are as before changes, and return to the “Louver setting” screen.
- To cancel “Louver lock”, press [] and [] to set louver not locked for the louver angle of each louver.
- When the operation mode is “Cool” or “Dry”, performing “Louver lock” at position (4) or (5) may cause condensation.
- For group connections, refer to <When multiple indoor units are connected as a group (group connection)>. (Page 57)
- “⌚” is displayed when “Louver lock” is set.

■ 3. Timer (Setting a timer to start or stop operation)



Selecting a timer type



- 1** In "Menu" (Page 17), select "Timer", and press [ Set/Fix]
- 2** Press [] and [] to select the timer you want to set
- 3** Press [ Set/Fix]

NOTE

About "Off timer" and "On timer" operations



- "Off timer" and "On timer" are enabled for only 1 time.
- "Off timer" and "On timer" do not operate in the following conditions.
 - When "Off timer" and "On timer" are disabled, during function settings, during central control (if "ON/OFF" is prohibited)
- When 2 remote controllers are connected, settings cannot be done on the "Follower remote controller".
- The setting range of "Off timer" and "On timer" is a minimum of 30 minutes and a maximum of 168 hours (7 days).
- Press [ Return] to not fix the changes, so conditions are as before changes, and return to the "Timer" screen.
- If there is a power outage, the "Off timer" and "On timer" settings are cancelled. (They become "OFF".)
- When "Off timer" and "On timer" are "ON", then  is displayed in the detailed display.

Off timer

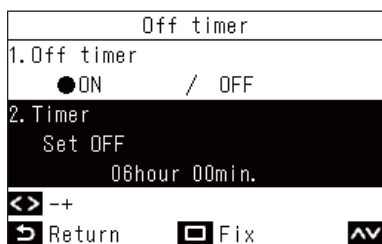
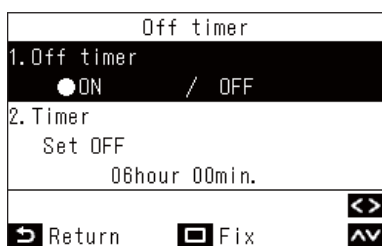

You can set the timer to the time at which to stop operation of an air conditioner.



1 In the “Off timer” screen, press [] and [] to select “Off timer”

2 Press []
→ Pressing [] cancels the settings.

3 Press [] and [] to select “Timer”

4 Press [] and [] to change the time
→ The time can be set in 30 minute intervals for up to 24 hours, and at 1 hour intervals after that.

5 Press [ Set/Fix]
→ Return to the “Timer” screen.

NOTE

- The air conditioner stops operating after the time set in “Off timer” has elapsed.
- In the period until the air conditioner operation is stopped by the “Off timer”, countdown of the “Off timer” continues even if the air conditioner is stopped and started.

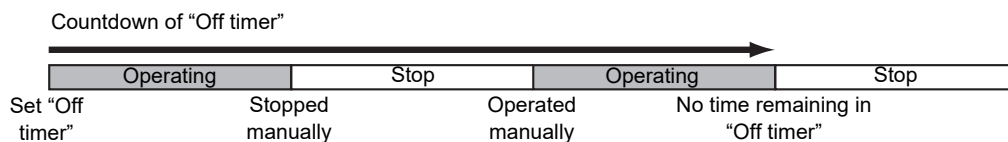

On timer

You can set the timer to the time at which to start operation of an air conditioner.

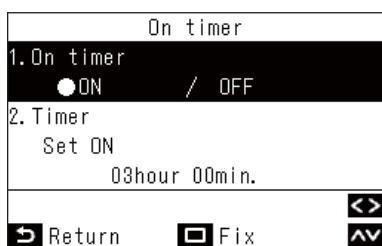

1 In the “On timer” screen, press [] and [] to select “On timer”

2 Press []
→ Pressing [] cancels the settings.

3 Press [] and [] to select “Timer”

4 Press [] and [] to change the time
→ The time can be set in 30 minute intervals for up to 24 hours, and at 1 hour intervals after that.

5 Press [Set/Fix]
→ Return to the “Timer” screen.

NOTE

- The air conditioner starts operating after the time set in “On timer” has elapsed.
- The air conditioner stops operating as soon as a time is set in “On timer”.
- When the air conditioner operation is started during the countdown of “On timer”, the “On timer” becomes “OFF”.

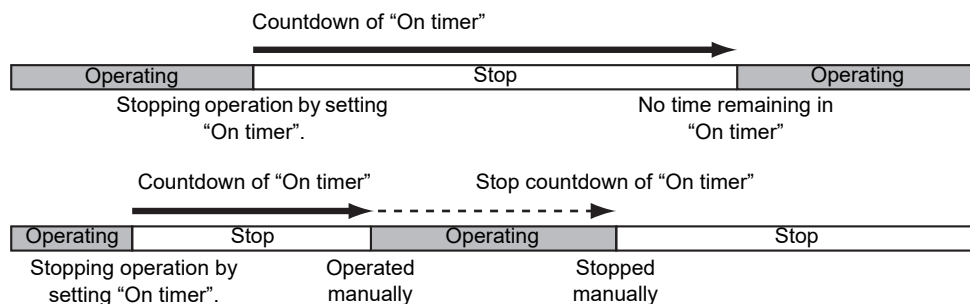

Off reminder timer

You can set the timer from the air conditioner operation start time to the stop time.



1 In the “Off reminder timer” screen, press [] and [] to select “Off reminder timer”

2 Press []
→ Pressing [] cancels the settings.

3 Press [] and [] to select “Timer”

4 Press [] and [] to change the time
→ Times can be set in 10 minute intervals.

5 Press [Set/Fix]
→ Return to the “Timer” screen.

NOTE

- The air conditioner starts operating, and after the set time has elapsed, the air conditioner stops operating.

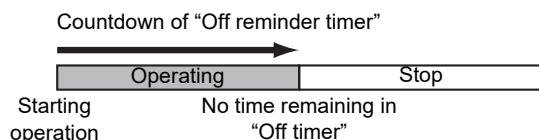

- “Off reminder timer” does not operate in the following conditions.
 - When “Off reminder timer” is disabled, during abnormalities, in test mode, during function settings, while a timer is set, and during central control (if “ON/OFF” is prohibited)
 - When 2 remote controllers are connected, settings cannot be done on the “Follower remote controller”.
 - The setting range of “Off reminder timer” is a minimum of 30 minutes and a maximum of 240 minutes.
 - Press [Return] to not fix the changes, so conditions are as before changes, and return to the “Timer” screen.
 - When “Off reminder timer” is “ON”, then is displayed in the detailed display.

4. Schedule timer (Setting 1-day operation schedule to do operations)

Set the operating schedule for 1 day, and then operate the air conditioner according to that schedule. You can operate at the same schedule every day, regardless of the day of the week, ("every day"), operate at a different schedule every day ("week"), or set a day without scheduled operations ("Holiday setting").

NOTE

An administrator password may be required.



1. In the password screen, press [^] and [v] to select numbers, and press [<] and [>] to select the input position
2. After inputting the password, press [Set/Fix]

* For the initial setting of the administrator password, refer to initial settings "Password setting" in Installation Manual.

You can turn operations on/off and change the temperature 8 times throughout each day

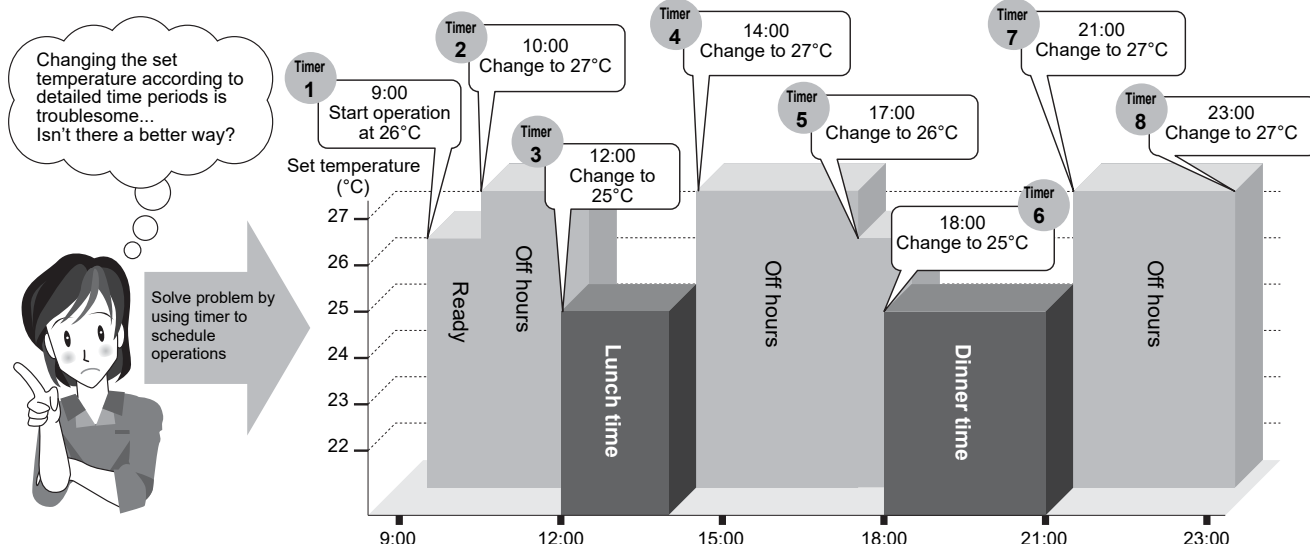

NOTE

- The schedule timer does not operate in the following conditions. When schedule timer is disabled, holiday is set using the schedule timer, the clock is flashing (not set), during abnormalities, in test mode, during function settings, while a timer is set and operating, and during central control (if "ON/OFF" is prohibited)
- When 2 remote controllers are connected, settings cannot be done on the "Follower remote controller".
- Before doing "Schedule timer", do "Clock". (Page 46)
- The time can be set in 1 minute increments.
- The temperature setting can be set in a range from 18°C to 29°C. (However, if "Set temp. range limit" has been set, then operation is done within that range)
- Press [Return] to not fix the changes, so conditions are as before changes, and return to the "Schedule timer" screen.
- The operation mode of "Schedule timer" becomes the operation mode of the previous operation time.
- Operating modes can be selected. For details, refer to "Setting timer operation mode" in "Field setting menu" in the Installation Manual.
- When "Schedule timer" is "ON", then "⌚" is displayed in the detailed display.

Setting the schedule timer to ON



- 1** In “Menu” (Page 17), select “Schedule timer”, and press [Set/Fix]
- 2** Press [^] and [v] to select “Schedule timer”
- 3** Press [^] to select “ON”
→ Press [v] and select “OFF” to cancel the settings.
- 4** Press [Set/Fix]
→ Return to the “Schedule timer” screen.

Condition setting	every day	Operate at the same schedule every day, regardless of the day of the week.
	week	Operate to a set 1-week schedule that is different every day of the week. Three 1-week schedules can be registered.
Holiday setting		Days specified as “Holiday setting” do not operate on the schedule timer even if they are set to operate under “Condition setting” in the schedule.

Condition setting (Setting 1-day operation schedules)

You can set a 1-day operation schedule.

In 1 schedule (1-day), you can set up to 8 patterns (operate, start time, temperature setting).

▼ every day (Same schedule every day, regardless of the day of the week)

Operation can be done at the same schedule every day, regardless of the day of the week.

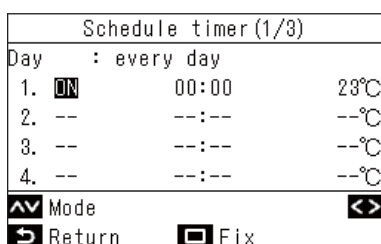
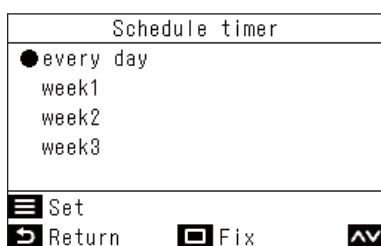

1 In the “Schedule timer” screen, press [] and [] to select “Condition setting”, and then press []

2 Press [] and [] to select “every day”, and then press []
→ Press [] and [] to check the current settings.
The settings are shown in 8 patterns.

3 Press []

4 Press [] and [] to select “--” (not set), “ON”, “OFF”, or “Auto”

5 Push [] to select the starting time and the set temperature
→ If “--” (not set) is displayed, the time and temperature cannot be set.

6 Press [] and [] to change the time and temperature settings
→ Press [] to switch to an item you want to change.

7 Press [] to move to the next pattern
→ Up to a total of 8 patterns can be set.
→ Do the settings in steps **4** to **6** to set each pattern.

8 Press []
→ A screen to confirm changes appears.

9 Press []
→ Return to the “Schedule timer” screen.

▼ week (Different schedule every day of the week)

Operation can be done to a different schedule every day of the week.

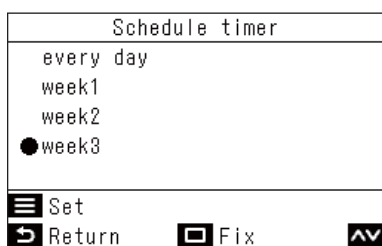
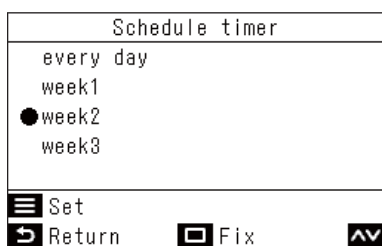
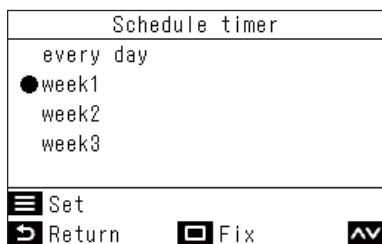
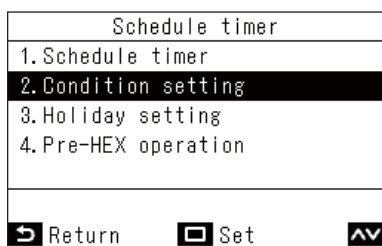

1 In the “Schedule timer” screen, press [] and [] to select “Condition setting”, and then press []

2 Press [] and [] to select one of “week1”, “week2”, or “week3”, and then press []

→ Three “week” can be set.

Press [] and [] to set each of “week1”, “week2”, and “week3” in steps **4** to **9**, and you can select one of them for operating.

→ Select a day and press [] and [] to check the settings for each day.

→ Press [] and [] to check the current settings. The settings are shown in 8 patterns.

3 Press []

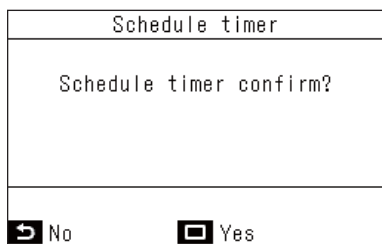
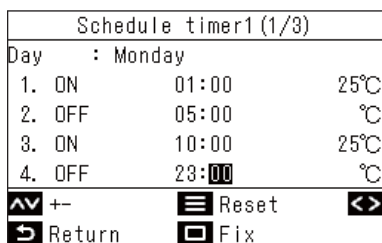
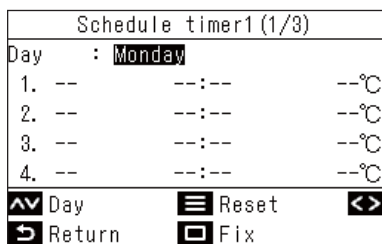
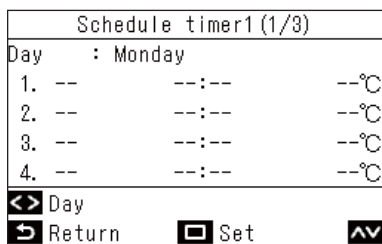

- 4** Press [] and [] to select a day, and then press []
- 5** Press [] and [] to select "--" (not set), "ON", "OFF", or "Auto" and the time and set temperature
→ Press [] to switch to an item you want to change.
- 6** Press [] to move to the next pattern
→ Up to a total of 8 patterns can be set for each day.
- 7** Press [] and [] to select a day
- 8** Press [] and [] to change the day (Make the settings for other days)
→ Do steps **4** to **8** to set all the days.

- 9** Press [Set/Fix]
→ A confirmation message is displayed.
 - If the settings are acceptable, press [Set/Fix]
 - To return to the settings screen, press [Return]

NOTE
To do other "week" settings, repeat steps **2** to **9**.

▼ Deleting settings for a day

Schedule timer1 (1/3)		
Day	: Monday	
1.	ON	01:00 25°C
2.	OFF	05:00 °C
3.	ON	10:00 25°C
4.	OFF	23:00 °C
	+-	Reset
	Return	Fix



Schedule timer	
Delete the day setting?	
No	<input type="checkbox"/> Yes

1 Press [Menu]

2 Press [Set/Fix]

- The schedule for the selected day is deleted.
- Press [Return] to return to the daily schedule settings screen.

▼ Copying the content of a previous day

Schedule timer1 (1/3)		
Day	: Tuesday	
1.	--	--:-- --°C
2.	--	--:-- --°C
3.	--	--:-- --°C
4.	--	--:-- --°C
	Day	Reset
	Return	Fix



Schedule timer	
Copy the previous day setting?	
No	<input type="checkbox"/> Yes

1 Press [ON/OFF]

2 Press [Set/Fix]

- The schedule settings for the day prior to the selected day are copied.
- Press [Return] to return to the daily schedule settings screen.

NOTE

Press [Return] to not fix the changes, so conditions are as before changes, and return to the “Schedule timer” screen. (Page 27)

Holiday setting (Days to not operate to a schedule timer)

Set the days of the week when no operation is performed in the "Schedule timer".

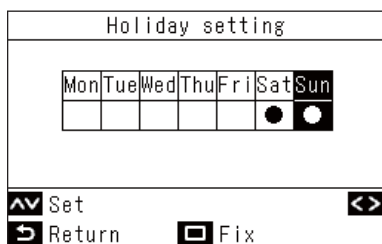

1 In the "Schedule timer" screen, press [] and [] to select "Holiday setting", and then press []

2 Press [] and [] to select a day, and press [] and [] to select set or delete
→ On days indicated by "●", operations are not done to "Schedule timer".

3 Press []
→ Return to the "Schedule timer" screen.

NOTE

- Operations other than schedule timer operations (such as remote controller operations and central control) can be done on days even if they are set as holidays.
- Press [] to not fix the changes, so conditions are as before changes, and return to the "Schedule timer" screen. (Page 27)

Pre-HEX operation

You can operate the ventilation before the air conditioner operates with the schedule timer.

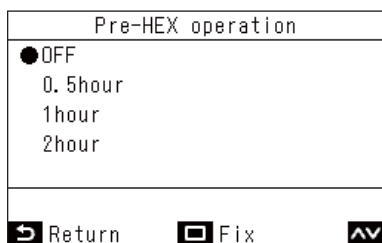

1 In the "Schedule timer" screen, press [] and [] to select "Pre-HEX operation", and then press []

2 Press [] and [] to select the time to do operations in advance

3 Press []
→ Return to the "Schedule timer" screen.

NOTE

- "Pre-HEX operation" does not operate in the following conditions.
 - If the schedule timer is set to "OFF"
 - If "Holiday setting" is set on the schedule timer for that day
 - If the date and time are not set in "Clock" (clock is flashing)
 - If an error occurs in the Air to Air Heat Exchanger (the check code and indoor unit number flash).
 - During "Test mode"
 - While "Σ" is displayed
 - If "Timer" is set to "ON" and while "Timer" is set
 - When the central control is used (when the run and stop operation is prohibited)
- They are set to "OFF" as the factory default setting.

■ 5. Night operation (Reducing operating noise of outdoor units)

You can set operating times, such as at night, to prioritize quietness by suppressing the operating noise of the outdoor units.

NOTE

An administrator password may be required.



1. In the password screen, press [] and [] to select numbers, and press [] and [] to select the input position
2. After inputting the password, press [Set/Fix]

* For the initial setting of the administrator password, refer to initial settings "Password setting" in Installation Manual.

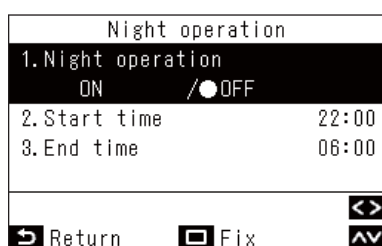

1 In "Menu" (Page 17), select "Night operation", and press [Set/Fix]

2 Press [] and [] to select "Night operation"

3 Press [] to select "ON"

→ If you select "OFF", the setting is not done.

→ Depending on the model connected, "LV1 / LV2 / LV3" is displayed instead of "ON", so an operation noise level can be selected.

(Operation noise level volume: LV1 < LV2 < LV3)

For detailed information, contact your supplier (dealer).

4 Press [] and [] to select "Start time"

5 Press [] and [] to change the start time

6 Press [] and [] to select "End time"

7 Press [] and [] to change the end time

8 Press [Set/Fix]

→ Return to "Menu".

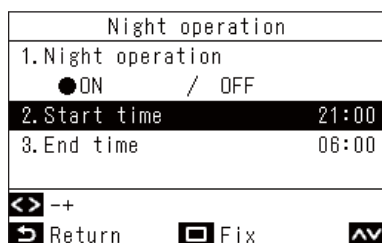



NOTE

- When connected to a model for which the "Night operation" feature is not available, the message "No function" is displayed. (For models for which this feature is available, refer to the catalogs or manuals of outdoor units.)
- If the same time is set for "Start time" and "End time", then quiet operation is done for 24 hours.
- While the outdoor unit is doing quiet operation, the operation gives priority to quietness, so cooling (warming) may be insufficient.
- Before doing "Night operation", do "Clock". (Page 46)
- When 2 remote controllers are installed, settings cannot be done on the "Follower remote controller".
- If one or more units belonging to the same refrigerant system are set for "Night operation", the feature can be enabled. If more than one remote controllers are connected to one system of outdoor units, "Night operation" can be set with those remote controllers. "Night operation" will start at the time set with each remote controller. For details of the operation, refer to the Service Guide.
- While the outdoor unit is doing quiet operation, "z_z" is displayed in the detailed display.

■ 6. Filter sign reset

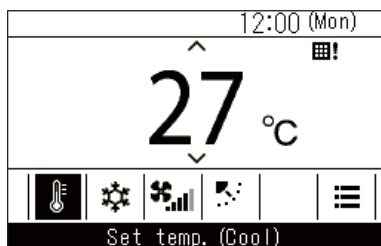
“!” appears on the detailed display to tell the time for cleaning the filter.





- When “!” is displayed, be sure to clean the filters and then do a reset.
For how to clean filters, refer to the Owner's Manual of the indoor unit.

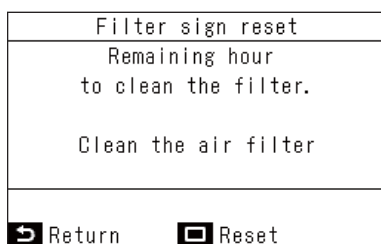

- If the air conditioners are operated while “!” is displayed, then “Filter check.” is displayed. Press an operation button while it is displayed or leave it for at least 5 seconds and the display will disappear.

When the filter check mark is displayed (filter check reset)



- 1** In “Menu” (Page 17), select “Filter sign reset”, and press [ Set/Fix]
- 2** Press [ Set/Fix]

**When the filter check mark is not displayed
(the time remaining until a filter check is displayed)**

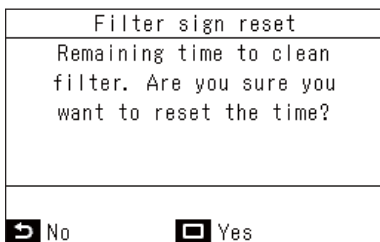

- 1** In “Menu” (Page 17), select “Filter sign reset”, and press [Set/Fix]
 - If you just want to check the time remaining until the filter check, press [Return] to return to the “Menu”.
- 2** To reset the time until it is time to clean the filters, press [Set/Fix]
- 3** Press [Set/Fix]

NOTE

- “Clean the air filter” or “Filter check.” appears on the display when there is no remaining time for filter cleaning.
- “!” is displayed even while the air conditioners are stopped.
- The remaining time for filter cleaning of the Header air conditioning unit is displayed when 2 or more indoor units are connected.
- The remaining time for filter cleaning differs depending on the connected indoor unit.

■7. Auto grille



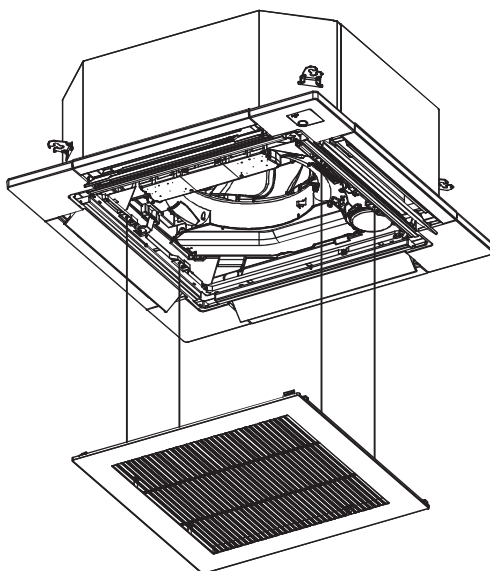

Do operations for the indoor unit's auto grille panel and auto grille kit.

NOTE

This function may not be available, depending on the indoor unit.



Auto grille	
▲	:Grille up
▼	:Grille down
ON/OFF	
	:Grille stop
▲▼	Grille
↻	Return

- 1** In "Menu" (Page 17), select "Auto grille", and press [ Set/Fix]
- 2** Press [] and [] to up / down the auto grille
→ Press [ ON/OFF] to stop the auto grille.
- 3** Press [ Return]
→ When "⌛" appears, return to "Menu".

NOTE

- If you select "Auto grille" during an operation, then operation stops.
- This function is not available on indoor units that have no auto grille function. "No function" is displayed.
- When doing auto grille operations (down, stop, up), the auto grille may take several seconds to down, stop, or up after the operation button is pressed.
- For details on the auto grille, refer to the Owner's Manual that comes with the auto grille panel or auto grille kit.
- For group connections, refer to <When multiple indoor units are connected as a group (group connection)>. (Page 57)

■ 8. Energy saving

Do settings related to energy savings, such as “Energy saving operation”, “Set temp. range limit”, “Return back”, “Saving operation”.

Energy saving (1/2)	
1. Energy saving operation	<OFF>
2. Set temp. range limit	
3. Return back	<OFF>
Return	Set

- 1** In “Menu” (Page 17), select “Energy saving”, and press [Set/Fix]
- 2** Press [] and [] to select an item
- 3** Press [Set/Fix]

Item	Description
1. Energy saving operation	Operates the air conditioners with suppressed performance.
2. Set temp. range limit	Limits the range of temperatures that can be set by the remote controller.
3. Return back	Sets to automatically return to a set temperature after the temperature setting is changed at the remote controller.
4. Saving operation	Operates to suppress excessive heating and excessive cooling. * For models that “Saving operation” is not available, the message “No function” is displayed.

CAUTION

For “Energy saving operation”, refer to the Owner's Manual of the device being used.

Energy saving operation

You can set this to save energy.

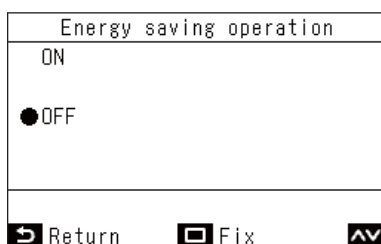
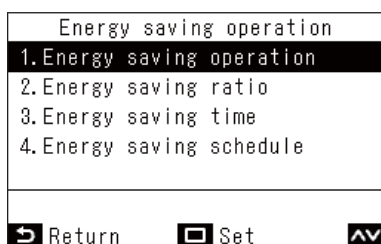

▼ Energy saving ratio

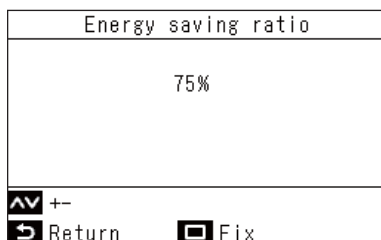
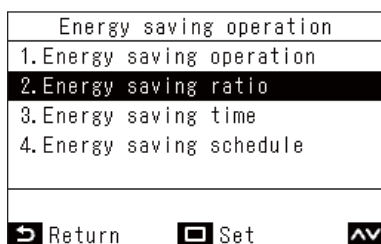

- 1** In the “Energy saving” screen, press [] and [] to select “Energy saving operation”, and then press []
- 2** Press [] and [] to select “Energy saving operation”, and then press []
- 3** Press [] and [] to select “ON” or “OFF”
→ To start “Energy saving operation”, set “Energy saving ratio”, “Energy saving time”, and “Energy saving schedule”.
- 4** Press []

- 1** In the “Energy saving operation” screen, press [] and [] to select “Energy saving ratio”, and then press []
- 2** Press [] and [] to change the values
→ An optional saving ratio can be set within a range of 50 to 100% in 1% increments. The lower the value, the higher the energy-saving effect on operations.
- 3** Press []
→ When “” appears, return to the “Energy saving operation” screen.

NOTE

- With “Energy saving operation”, operation is done by suppressing the performance of the air conditioners, so cooling (warming) may be insufficient.
- When 2 remote controllers are connected, settings cannot be done on the “Follower remote controller”.
- Before setting “Energy saving operation”, do “Clock”. (Page 46)
- This setting may not be possible by using the remote controller, depending on the settings of the outdoor unit or central control device.
- Energy saving schedule operation is not done if the clock is flashing (not set).
- An optional saving ratio of 100% is normal operation.
- When “Energy saving operation” is being done, “” is displayed on the screen.

▼ Energy saving time settings

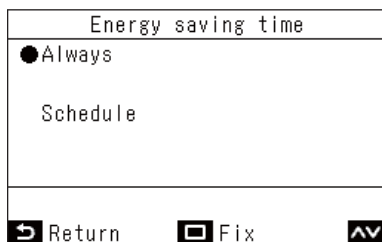
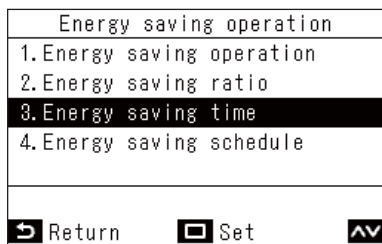

- 1 In the “Energy saving operation” screen, press [^] and [v] to select “Energy saving time”, and then press [□ Set/Fix]
- 2 Press [^] and [v] to select “Always” or “Schedule”

Always	Sets the same saving ratio for the entire day.
Schedule	Sets saving ratios, and whether to do saving, for each hour.

- 3 Press [□ Set/Fix]
→ Return to the “Energy saving operation” screen.

▼ Energy saving schedule

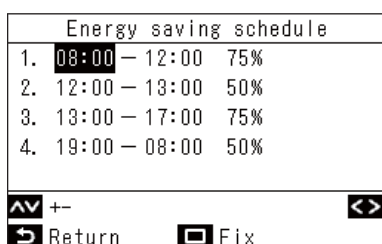
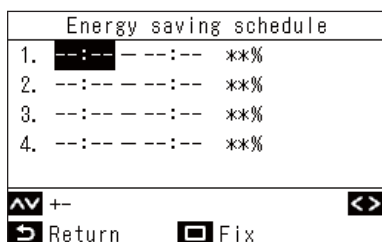
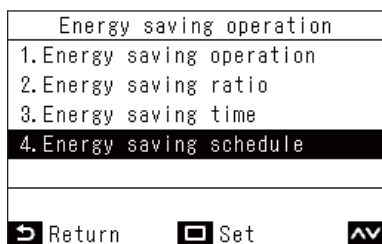

- 1 In the “Energy saving operation” screen, press [^] and [v] to select “Energy saving schedule”, and then press [□ Set/Fix]
→ If the clock is not displayed, go to the “Clock” screen. (Page 46)
- 2 Press [^] and [v] to change the time and saving ratio
→ Press [<] and [>] to switch to an item you want to change.
- 3 Press [□ Set/Fix]
→ Return to the “Energy saving operation” screen.

NOTE

- The saving ratio for “Always” is the value set for “Energy saving ratio”.
- The times set for the energy saving schedule can be set from 0:00 to 23:50 in 10 minute increments.
- The saving ratios for the energy saving schedule can be selected from “75%”, “50%”, or “0%(OFF)”.
* “75%” is the value set for “Energy saving ratio”.
- Before doing “Energy saving schedule”, do “Clock”. (Page 46)
- The saving ratio and operating power level display may not be in proportion depending on the operating status.
- If different saving ratios are set in the same time period, the lower saving ratio is used for operations.

Set temp. range limit

The range of temperature settings can be set individually for operation modes.

Energy saving (1/2)	
1. Energy saving operation	<OFF>
2. Set temp. range limit	
3. Return back	<OFF>
Return	Set

Set temp. range limit		
	Minimum	Maximum
Cool	18°C	29°C
Heat	18°C	29°C
Dry	18°C	29°C
Auto	18°C	29°C
+-		
Return	Fix	

1 In the “Energy saving” screen, press [] and [] to select “Set temp. range limit”, and then press [Set/Fix]

2 Press [] and [] to change the temperature

→ Press [] and [] to switch to an item you want to change.

3 Press [Set/Fix]

→ Return to the “Energy saving” screen.

NOTE

When “Error” is displayed

- In any of the operation modes, if the upper limit temperature is lower than the lower limit temperature, or if the lower limit temperature is higher than the upper limit temperature, when [Set/Fix] is pressed, “Error” is displayed. Press [Return] while it is displayed or leave it for 10 seconds to return to the condition prior to pressing [Set/Fix].

Priority of “Set temp. range limit”

- When 2 remote controllers are connected, align the settings on the 2 remote controllers to use them.
- In the following cases, the operation may be outside of the “Set temp. range limit”.
 - If “Set temp. range limit” is different on the 2 remote controllers that are connected.
 - If a temperature is set from the central control device that exceeds “Set temp. range limit”.

Return back

Even if you change the set temperature, it will return to the “Return temp.(Cool)” or “Return temp.(Heat)” at “Return time” that has been set previously.

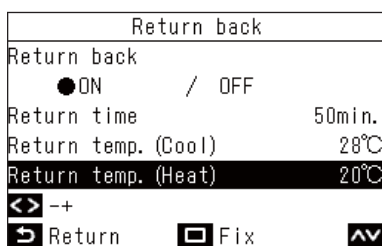
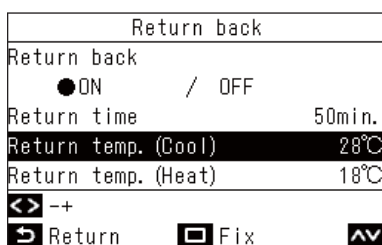
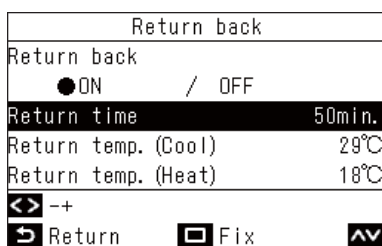
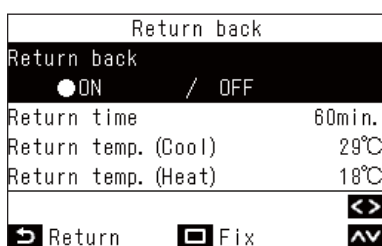
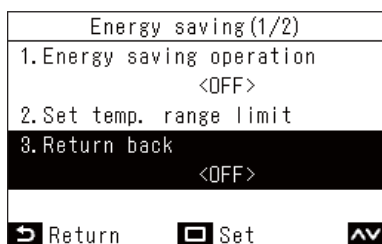

1 In the “Energy saving” screen, press [] and [] to select “Return back”, and then press [Set/Fix]

2 Press [] and [] to select “Return back”

3 Press [] to select “ON”
→ If you select “OFF”, the setting is not done.

4 Press [] and [] to select “Return time”, and then press [] and [] to change the time

→ You can set from 10 to 120 minutes in 10 minute increments.

5 Press [] and [] to select “Return temp.(Cool)” or “Return temp.(Heat)”, and then press [] and [] to change the set temperature

6 Press [Set/Fix]
→ Return to the “Energy saving” screen.

NOTE

When 2 remote controllers are connected, settings cannot be done on the “Follower remote controller”.

Saving operation

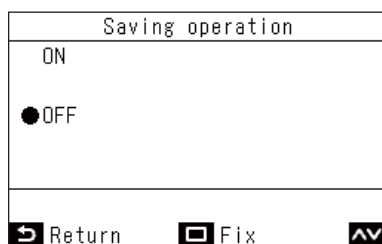
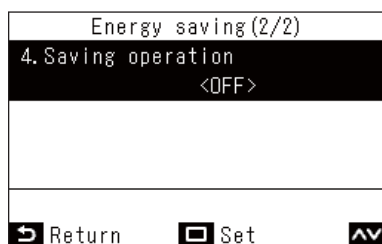

- 1** In the “Energy saving” screen, press [] and [] to select “Saving operation”, and then press [Set/Fix]
- 2** Press [] to select “ON”
→ If you select “OFF”, the setting is not done.
- 3** Press [Set/Fix]
→ Return to the “Energy saving” screen.

NOTE

- The comfort of a room is determined from such data as the room temperature, fan speed, and outside temperature, which are averaged over the past 20 minutes to automatically adjust the set temperature to within a range so that comfortableness does not fluctuate extremely.
- The temperature range for automatic compensation is as shown below.
“Cool”: +1.5°C to -1.0°C
“Heat”: -1.5°C to +1.0°C
The set temperature display on the remote controller does not change.
- When the operation mode is “Cool”, “Heat”, or “Auto”, “Saving operation” is done.
“Saving operation” cannot be used, depending on the indoor unit that is connected.
- When 2 remote controllers are connected, settings cannot be done on the “Follower remote controller”.
- When “Saving operation” is being done, is displayed on the remote controller screen.

■ 9. Monitor

You can check the current operating conditions.

Menu (2/3)	
6. Filter sign reset	
7. Auto grille	
8. Energy saving	
9. Monitor	
10. Initial setting	
Return	Set

1 In “Menu” (Page 17), select “Monitor”, and press []

2 Press [] and [] to switch pages

Monitor	
(1) Set temp.	27°C
(2) Control temp.	23°C
(3) Outdoor temp.	35°C
(4) Filter remaining hour	1250
(5) Total running hour	38
Return	

- (1) Displays the set temperature.
- (2) Displays the ambient temperature of the indoor unit intake. Displays the remote controller sensor value when the remote controller sensor is set.
- (3) Displays the ambient temperature of the outdoor unit intake.
- (4) Displays the time remaining until the filter check mark “” appears.
- (5) Displays the total running hour.

NOTE

About total running hour

- The operating time of the air conditioners is calculated and displayed on the remote controller.
- The time is not recorded during self clean operation or “Individual ventilation”.

About outdoor unit ambient temperature

- Displays the ambient temperature of the outdoor unit intake.
- This may be different from the actual outside temperature.





Other

- When multiple indoor units are connected as a group, the header unit status is displayed.
- * If there are no button operations in the “Monitor” screen for 60 seconds, the “Menu” screen returns.

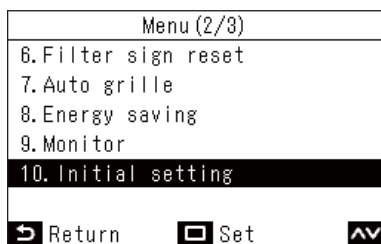
■ 10. Initial setting

Set the initial setting of the remote controller.



- 1** In “Menu” (Page 17), select “Initial setting”, and press [ Set/Fix]
- 2** Press [] and [] to select an item
- 3** Press [ Set/Fix]

Item	Description
1. Clock	You can set the year, month, date, and time.
2. Name of room	Refer to the Installation Manual of the Wired remote controller.
3. Display setting	Refer to the Installation Manual of the Wired remote controller.
4. Screen contrast	The contrast of the LCD can be adjusted.
5. Light & LED	The operating LED and the backlight of the LCD can be turned off permanently.
6. Sound	The sound of button operations can be turned off.
7. Key lock	Button operations can be locked.
8. Password setting	Refer to the Installation Manual of the Wired remote controller.
9. Header/Follower	Refer to the Installation Manual of the Wired remote controller.
10. Language	Refer to the Installation Manual of the Wired remote controller.
11. Press & hold 4 sec.	Refer to the Installation Manual of the Wired remote controller.
12. Summer time	Refer to the Installation Manual of the Wired remote controller.
13. Clock synchronisation	Refer to the Installation Manual of the Wired remote controller.
14. Bluetooth	Refer to the Owner's Manual of the Bluetooth® function.

Clock

You can set the year, month, date, and time.

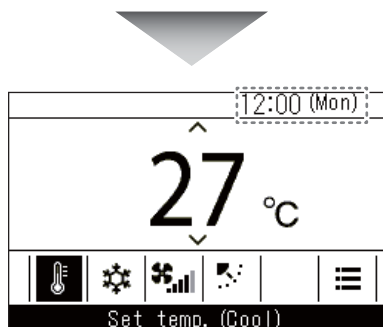
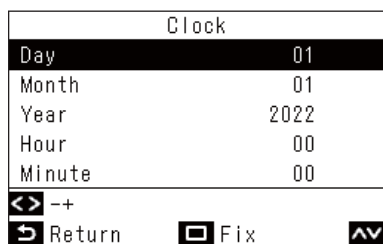
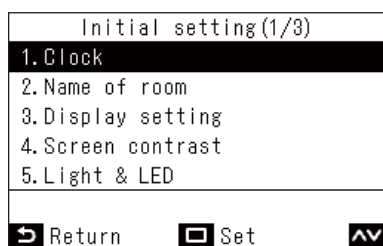

1 In the “Initial setting” screen, press [] and [] to select “Clock”, and then press []

2 Press [] and [] to change the year, month, date, and time
→ Press [] and [] to switch to an item you want to change.

3 Press []
→ Return to the “Initial setting” screen.

When the settings are complete, the time and day appear in the top right of the main screen.

NOTE

- Use the same procedure to change a “Clock” that has been set.
- The year, month, and date can be set from January 1, 2022 to December 31, 2099.
- The clock display flashes if the clock data is lost, such as due to a blackout. If a blackout happens, the time is maintained for about 3 days.
- The clock accuracy is an average monthly deviation of +/- 60 seconds.

Screen contrast

You can adjust the contrast of the LCD.

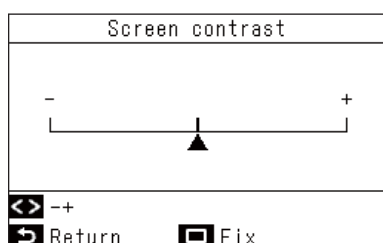

1 In the “Initial setting” screen, press [] and [] to select “Screen contrast”, and then press []

2 Press [] and [] to select the value you want to change

3 Press []
→ Return to the “Initial setting” screen.

NOTE

It is set to the central value as the factory default setting.

Light & LED

Select whether to enable lighting of the operating LED and the backlight of the LCD.

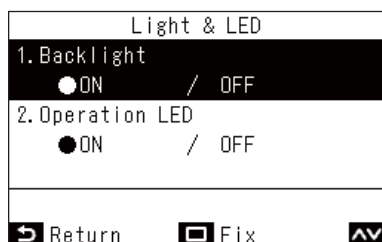

- 1** In the “Initial setting” screen, press [] and [] to select “Light & LED”, and then press []
- 2** Press [] and [] to select the item you want to change
- 3** Press [] and [] to select “ON” or “OFF”
- 4** Press []
→ Return to the “Initial setting” screen.

NOTE

They are set to “ON” as the factory default setting.

Sound

You can set the sound of button operations on the remote controller.

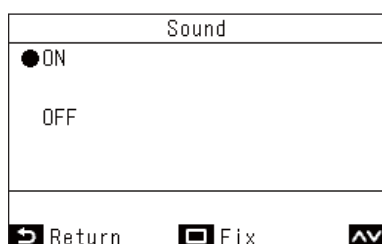
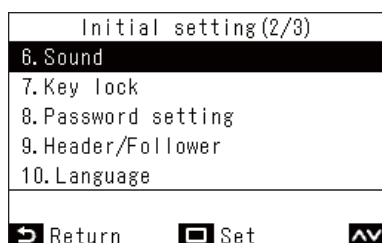

- 1** In the “Initial setting” screen, press [] and [] to select “Sound”, and then press []
- 2** Press [] and [] to select “ON” or “OFF”
- 3** Press []
→ Return to the “Initial setting” screen.

NOTE

- There are no sounds when doing operations on the “Menu”.
- They are set to “ON” as the factory default setting.

Key lock (Select operations to lock)

You can select operations to lock by using operation lock (Page 59).

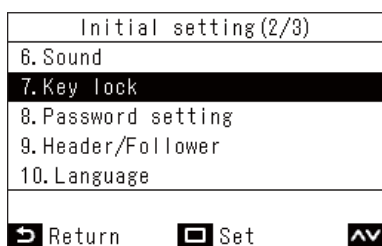

1 In the “Initial setting” screen, press [] and [] to select “Key lock”, and then press [Set/Fix]

2 Press [] and [] to select the item you want to change

3 Press [] and [] to select “Lock” or “Unlock”

4 Press [Set/Fix]

→ Return to the “Initial setting” screen.

→ To lock operations, in the main screen, press and hold [Return] for more than 4 seconds. (Page 59)

NOTE

- They are set to “Lock” as the factory default setting.
- When check codes are displayed, all the operation locks are released.

- If you select “Lock” for “ALL”, then all operation items are locked, regardless of other item selections.
- Even if you select “Unlock” for “ALL”, the operation of “Wind direction” and [Menu] are locked.
- If you select “Unlock” for “ALL”, then the operations for which “Lock” is selected in “Wind direction” and [Menu], as well as “ON/OFF”, “Set temp.”, “Mode”, and “Fan Speed”, are locked.

Setting items	Setting	Locked operation						
		ON/OFF	Set temp.	Mode	Fan Speed	Wind direction	Menu	Other setting
ALL	Lock	✓	✓	✓	✓	✓	✓	✓
	Unlock					✓	✓	✓
ON/OFF	Lock	✓				✓	✓	✓
Set temp.	Lock		✓			✓	✓	✓
Mode	Lock			✓		✓	✓	✓
Fan Speed	Lock				✓	✓	✓	✓

11. Ventilation

You can set the ventilation to be linked to the air conditioners.

NOTE

- This function may not be available, depending on the model of the indoor unit.
- Items that cannot be set are not shown, according to the model.

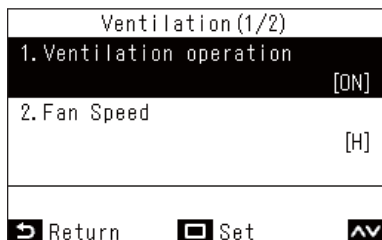

- 1** In "Menu" (Page 17), select "Ventilation", and press [Set/Fix]
- 2** Press [^] and [v] to select an item
- 3** Press [Set/Fix]

Item	Description
1. Ventilation operation	Do "ON" or "OFF" for ventilation.
2. Fan speed	Select the "Fan speed".
3. Mode	Select the "Mode".
4. 24h ventilation off	Stop 24 hour ventilation operation.
5. Schedule timer	Set the schedule for ventilation. * This can only be set when an air to air heat exchanger is connected alone.

Ventilation operation (ON or OFF for ventilation)

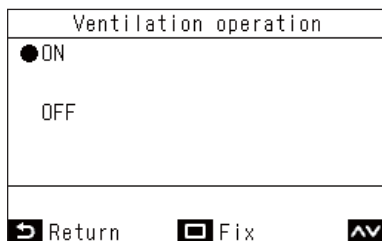

- 1** In the "Ventilation" screen, press [^] and [v] to select "Ventilation operation", and then press [Set/Fix]
- 2** Press [^] and [v] to select "ON" or "OFF"
- 3** Press [Set/Fix]
→ Return to the "Ventilation" screen.

NOTE

- If no ventilation unit is connected, or if settings to enable "Individual ventilation" operations are not set, "Impossible" is displayed.
- "Fan speed", "Mode", and "24h ventilation off" can only be set when our Air to Air Heat Exchanger of the VN-M*HE* Series or VN-*SY-E is connected to your system. "Schedule timer" can only be set when our Air to Air Exchanger of the VN-*SY-E Series is connected to your system. For details, refer to the Owner's Manual of Air to Air Heat Exchanger.
- When a setting is configured to enable "Individual ventilation" operation with an air to air heat exchanger other than the VN-M*HE* Series connected, "⚠" is displayed in the Details screen during ventilation operation.

Fan speed

Fan Speed	
<input checked="" type="radio"/> H	
<input type="radio"/> M	
<input type="radio"/> L	
Supply air>Exhaust air H	
Supply air>Exhaust air M	
Auto	
<input type="button" value="Return"/>	<input type="button" value="Fix"/> <input type="button" value="AV"/>

- 1** In the “Ventilation” screen, press [] and [] to select “Fan speed”, and then press []
- 2** Press [] and [] to select “Fan speed”
- 3** Press []
→ Return to the “Ventilation” screen.

Mode

Mode	
<input checked="" type="radio"/> Automatic	
Heat exchange	
Bypass	
<input type="button" value="Return"/>	<input type="button" value="Fix"/> <input type="button" value="AV"/>

- 1** In the “Ventilation” screen, press [] and [] to select “Mode”, and then press []
- 2** Press [] and [] to select “Mode”
- 3** Press []
→ Return to the “Ventilation” screen.

24h ventilation off

24h ventilation off	
Temporary stop of 24h ventilation	
<input type="button" value="Return"/> No	<input type="button" value="Yes"/>

- 1** In the “Ventilation” screen, press [] and [] to select “24h ventilation off”, and then press []
→ A screen to confirm appears.
- 2** Press []
→ Return to the “Ventilation” screen.

Schedule timer

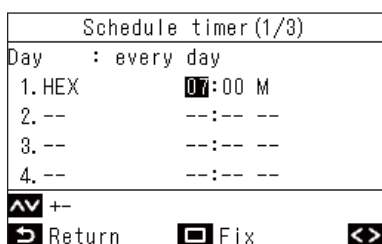
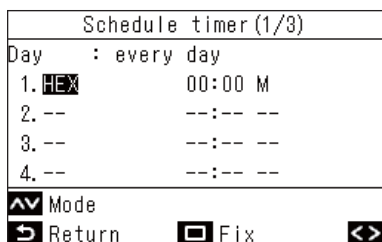
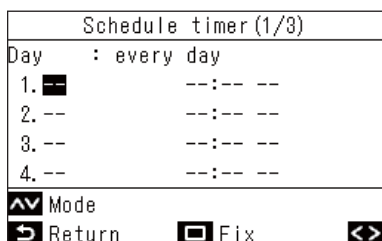
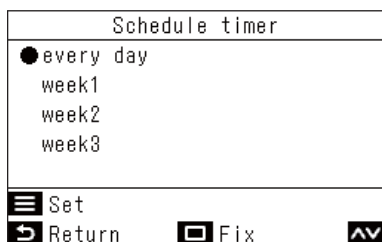
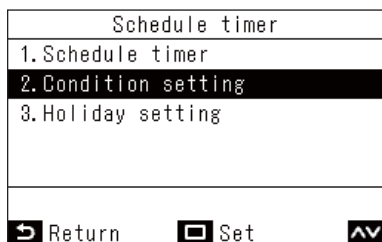

- 1** In the “Ventilation” screen, press [] and [] to select “Schedule timer”, and then press [Set/Fix]
- 2** Press [] and [] to select “Condition setting”, and then press [Set/Fix]
- 3** Press [] and [] to select “every day”, and then press [Menu]
- 4** Press [Set/Fix]
- 5** Press [] and [] to select “--” (not set), “ON”, “OFF” or a ventilation mode
- 6** Press [] to select start time and fan speed
→ If “--” (not set) is displayed, the fan speed and time cannot be set.
- 7** Press [] and [] to change the time and fan speed
→ Press [] to switch to an item you want to change.
- 8** Press [] to move to the next pattern
→ Up to a total of 8 patterns can be set.
→ Do the settings in steps **5** to **7** to set each pattern.
- 9** Press [Set/Fix]
→ A screen to confirm changes appears.
- 10** Press [Set/Fix]
→ Return to the “Schedule timer” screen.

NOTE

- The items that are displayed vary depending on the model setting of the Air to Air Heat Exchanger.
- For details on setting “week”, refer to <week (Different schedule every day of the week)>. (Page 30)

■ 12. Soft Cooling

Does settings to switch to “Soft Cooling” operations to reduce the sense of draughtiness, when “Cool” is set, by correcting louvre angle and suppressing performance.

NOTE

This function may not be available, depending on the model of the indoor unit.

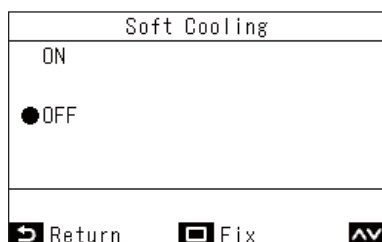
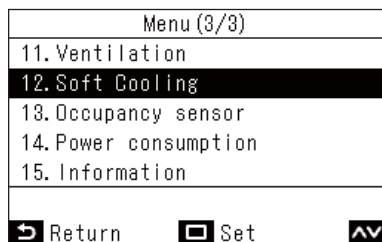

1 In “Menu” (Page 17), select “Soft Cooling”, and press [ Set/Fix]

2 Press [] and [] to select “ON” or “OFF”

3 Press [ Set/Fix]
→ Return to “Menu”.

NOTE

- With “Soft Cooling” operation, operation is done by suppressing the performance of the air conditioners, so cooling may be insufficient.
- For models that “Soft Cooling” is not available, the message “No function” is displayed.
- For models that cannot set wind direction, the air conditioner just operates at suppressed performance.
- When “Soft Cooling” operation is being done, “” is displayed on the screen.

■ 13. Occupancy sensor

The Occupancy sensor, which is sold separately, can determine whether or not people are present, and automatically do energy-saving operations when no one is present.

NOTE

This can only be used when the Occupancy sensor, which is sold separately, is connected.

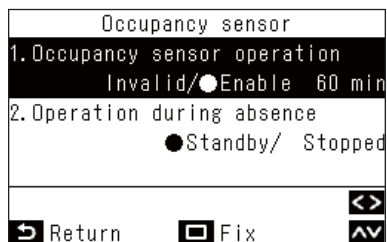

- 1 In "Menu" (Page 17), select "Occupancy sensor", and press [Set/Fix]

Item	Description
Occupancy sensor operation	Set the occupancy sensor to "Invalid" or "Enable"; if "Enable" is set, then decide the length of time until the sensor determines no one is present. The factory default setting for the time to determine if no one is present is "60 min", but settings of "Invalid", "30 min", "60 min", "90 min", "120 min", or "150 min" can be selected.
Operation during absence	Decide the operation of the air conditioners when no one is present. (They are set to "Standby" as the factory default setting.) "Standby": Circulation mode (thermo off) "Stopped": Stops operation of air conditioners

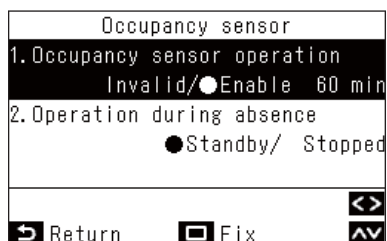

- 2 Press [] and [] to select "Occupancy sensor operation"
- 3 Press [] and [] to select "Invalid" or "Enable", when "Enable" is selected, select the time to determine no one is present
- 4 Press [] and [] to select "Operation during absence"
- 5 Press [] and [] to select "Standby" or "Stopped"
- 6 Press [Set/Fix]
→ Return to "Menu".

NOTE

If Occupancy sensor is not connected, then "No function" is displayed.

■ 14. Power consumption

The power consumption is displayed in a graph. (It may not be displayed depending on the models.)

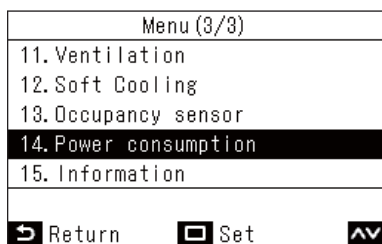

- 1** In “Menu” (Page 17), select “Power consumption”, and press [Set/Fix]
- 2** Press [] and [] to select the type of graph to be displayed
 → The types of graphs are explained below.
- 3** After confirming the graph, press [Return]
 → Return to “Menu”.

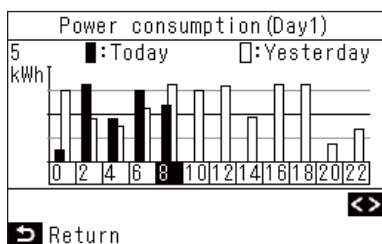

“Day1”
 Displays today’s and yesterday’s data.

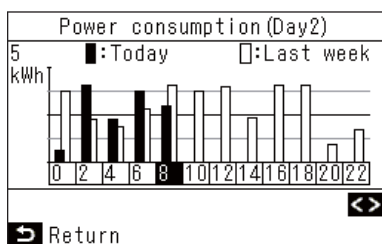

“Day2”
 Displays data for the same day of the week today and last week.

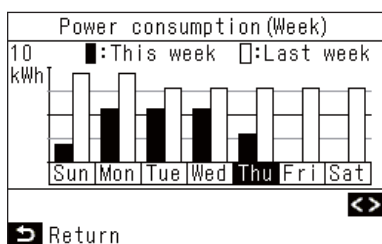

“Week”
 Displays data for this week and last week.

NOTE

- This function can only be used with corresponding indoor units and outdoor units.
 This feature is not available if the equipment group connected to the remote controller includes an unsupported model, air to air heat exchanger, or ventilation unit. The message “No function” is displayed.
- Graph data is updated every 30 minutes.
- The power consumption displayed is just an estimate as it is calculated simply. It may sometimes differ from the result measured by the power meter.
- Do not use the values of display for considering the contracted power and calculating the power charge.
- Data is displayed at that time during the summer time period.
- When a power failure occurs, data for up to 30 minutes before the power failure will not be displayed.
- When setting data for the indoor unit is checked and/or changed, data for that period of time may not be displayed.
- When two remote controllers are connected, display function is not available with “Follower remote controller”.
- Before using “Power consumption”, do “Clock”. (Page 46)
- If no button operation is done for 60 seconds, the display returns to the “Menu”.

■ 15. Information

Checking the Model information

You can confirm information regarding model names and serial numbers.

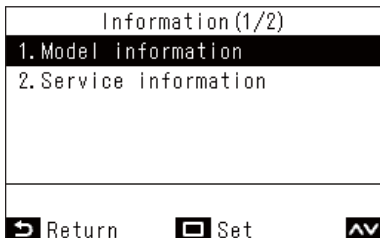

1 In “Menu” (Page 17), select “Information”, and press [ Set/Fix]

2 Press [] and [] to select “Model information”, and then press [ Set/Fix]

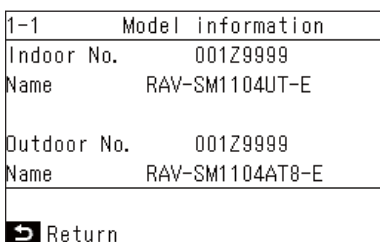

When central control is done

The following message appears for 5 seconds if you press an operation button that has been locked due to an operation lock by central control.

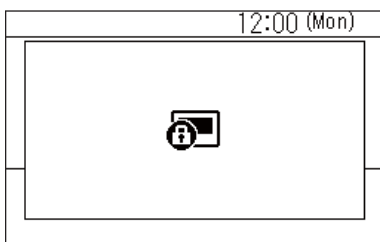

Operation locks applied by central control

- Prohibiting stopping of operations
- Prohibiting changing of operation modes
- Prohibiting changing of set temperatures
- Prohibiting changing of fan speed

Other

■ Individual temperature settings for “Cool” and “Heat” in auto operation modes (dual set point)

With dual set point settings, you can set individual temperature settings for “Cool” and “Heat” operations to adjust the indoor temperature. To use this, ask your dealer to set it.

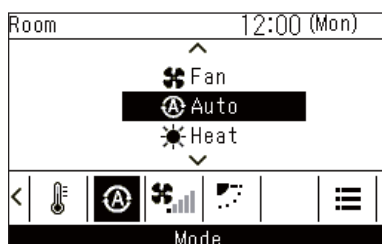

- 1** Press [<] and [>] to switch to the “Mode” screen
- 2** Press [^] and [v] to select “Auto”
- 3** Press [<] and [>] to switch to the “Set temp.” screen

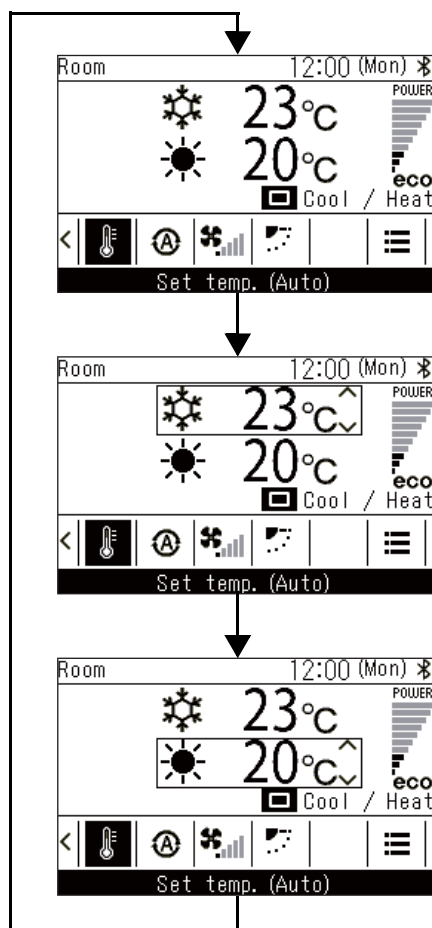

- 4** Press [□ Set/Fix]

“Cool”

- 5** Press [□ Set/Fix]
- 6** Press [^] and [v] to change the temperature setting for “Cool”

“Heat”

- 7** Press [□ Set/Fix]
- 8** Press [^] and [v] to change the temperature setting for “Heat”

■ When multiple indoor units are connected as a group (group connection)

You can connect multiple indoor units as 1 group and operate the indoor units in the group from 1 or 2 remote controllers connected to the group. (Group connection)

When there is a group connection, you can set "Individual louver", "Swing type", "Louver lock", "Auto grille", and "Model information" separately for each indoor unit.

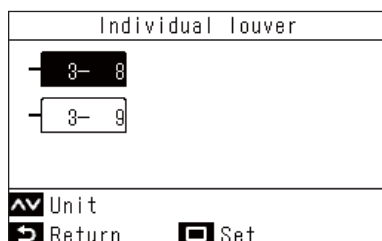

1 In "Menu" (Page 17), select "Wind direction", "Individual louver", "Swing type", "Louver lock", or "Auto grille", and press [Set/Fix]

2 Press [] and [] to select a unit

3 Press [Set/Fix]
 → Press [Set/Fix] to open the settings screen for each unit.

4 Refer to the following to change the settings of each unit

- "Individual louver" (Page 20)
- "Swing type" (Page 21)
- "Louver lock" (Page 22)
- "Auto grille" (Page 37)
- "Model information" (Page 55)

5 Press [Return]
 → Press [Return] to return to the previous screen.
 → For "Swing type", "Louver lock", and "Auto grille", when you press [Return], "∞" appears.

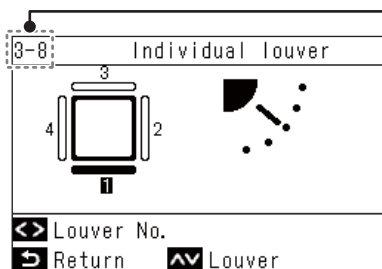

- The selected unit number (address) is displayed on the upper left. This is not displayed if all the units are selected.
- All the units cannot be selected for some settings.

■ Link and operate the Air purifier function of indoor units

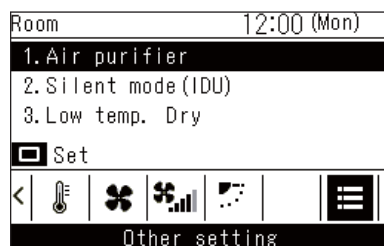

1 Press [<] and [>] to switch to the “Other setting” screen

2 Press [^] and [v] to select “Air purifier”, and then press [□ Set/Fix]

→ “ON” or “OFF” is displayed to indicate the state of the feature.

3 Press [^] and [v] to select “ON” or “OFF”, and then press [↵ Return]

→ Return to the “Other setting” screen.

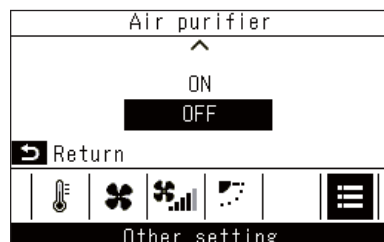

■ Silent mode(IDU)

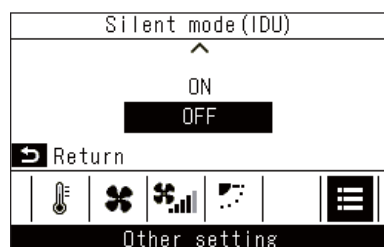

1 In the “Other setting” screen, press [^] and [v] to select “Silent mode(IDU)”, and then press [□ Set/Fix]

→ Whether the function is “ON” or “OFF” is displayed.

2 Press [^] and [v] to select “ON” or “OFF”, and then press [↵ Return]

→ Return to the “Other setting” screen.

■ Low temp. Dry

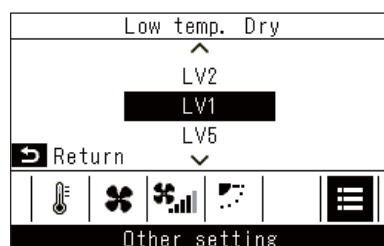

1 In the “Other setting” screen, press [^] and [v] to select “Low temp. Dry”, and then press [□ Set/Fix]



2 Press [^] and [v] to select level, and then press [↵ Return]

→ Return to the “Other setting” screen.

■ Lock operations (operation lock)

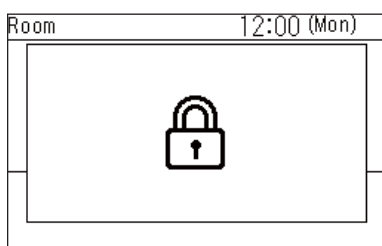
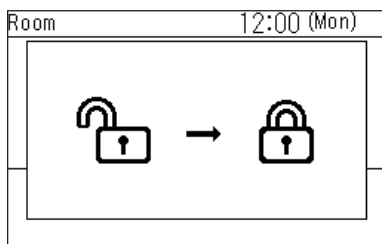
You can lock operations to prevent incorrect operations.





- 1** Press and hold [ Return] for more than 4 seconds to lock operations
- 2** Press and hold [ Return] for more than 4 seconds to release locked operations
 - Locked operations can be selected. For details, refer to <Key lock (Select operations to lock)>. (Page 48)
 - If a locked operation is done, “” is displayed.

■ Self clean operation

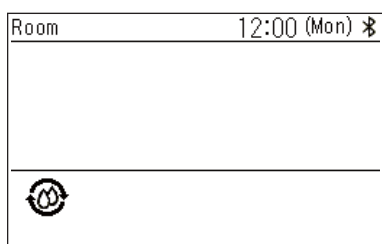
This function keeps the inside of the indoor unit dry and clean by doing fan operations inside the indoor units after “Auto (Cool)”, “Cool” and “Dry” operations.



- Self clean operation time varies depending on the model. Refer to the Owner's Manual of the indoor unit.
- To force self clean operation to stop, press the [ ON/OFF] button, then after more than 3 seconds of operation, press [ ON/OFF] again.
- During self clean operation, “” is displayed on the remote controller. The operation LED turns off.

7 Maintenance

Turn off the power before maintenance.





Do not operate the unit with wet hands
Doing so may result in electric shock.

■ Daily

Wipe the remote controller with a soft dry cloth. Washing it with water may cause a failure.

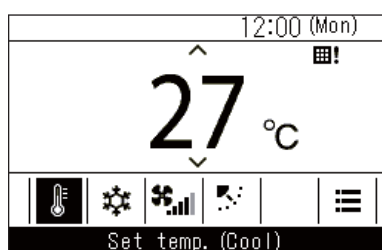
■ Cleaning the filters



When “

(This is not shown in the simple display.)

- Clogged filters may cause lower cooling and heating performance.

8 Troubleshooting

■ Confirm and check

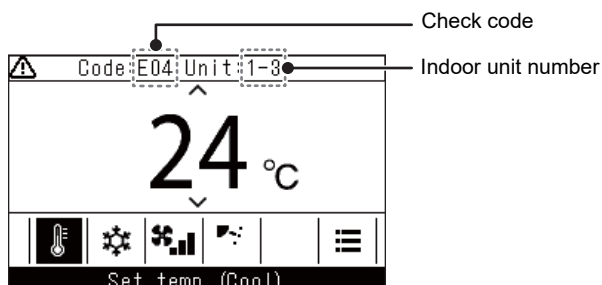

When an error occurs in the air conditioner, the check code and the indoor unit number flash on the display of the remote controller.

* The check code is only displayed during the operation.

When the check code and indoor unit number are displayed, pressing [Return] opens the "Check" screen.

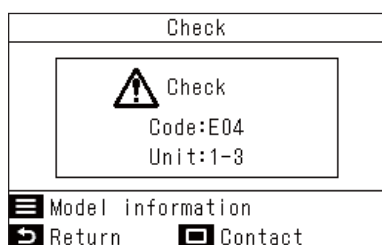

In the "Check" screen, press [Set/Fix] to show the contacts.

Press [Menu] to display "Model information".

■ Contact information for repairs

You can look for contact information for repairs.



1 In the "Information" screen, press [] and [] to select "Service information", and then press [Set/Fix]

Carrier Japan Corporation

336 TADEHARA, FUJI-SHI, SHIZUOKA-KEN 416-8521 JAPAN

DEC1319001-1